

Ultraviolet Photoelectron Spectroscopy (UPS)-1

Louis Scudiero

<http://www.wsu.edu/~scudiero>; 5-2669

scudiero@wsu.edu

Koopmans' Theorem

The binding energy of an electron in state i is equal to the negative of the orbital energy of the i^{th} state.

$$I_i = -\epsilon_i$$

(the ion is represented by (N-1) frozen orbitals)

Koopmans' theorem makes possible the identification of calculated orbital energies with ionization potentials.

But it does not allow for electronic relaxation

The ionization energy for the removal of electrons from different orbitals in a molecule is given by the energy difference between the initial state of the neutral molecule (in the ground state) and the final state that is the state of the ionized molecule.

1. Intra-molecular relaxation (relaxation energy for a free molecule)
The N-1 electrons are rearranged around the hole, leading to lowering of the energy.

2. Extra-molecular Relaxation

When a gas is chemisorbed on a surface the energy levels of the chemisorbed molecule are shifted relative to those of the free gas.

Effects: Bonding (initial state)

Relaxation (final state) or (polarization screening)

The measured binding energy is always lower than the one calculated from Koopmans' theorem.

Example: O 1s in CO

$$BE (expt) = 532.3 \text{ eV}$$

$$BE (Koopmans) = 562.4 \text{ eV}$$

O 2s

$$BE (expt) = 38.9 \text{ eV}$$

$$BE (Koopmans) = 41.1 \text{ eV}$$

UV Commonly Used Lines (16.6 to 40.8 eV)

Ionization sources are Ne I (16.6 eV), Ne II (26.8 eV) and He I (21.2 eV), He II (40.8 eV).

These lines are produced by cold cathode capillary discharge. They represent resonance fluorescence produced when the gas is excited in the discharge and then decays back to its ground state.

I -- light emitted from neutral atoms

II -- light emitted by singly ionized atoms

The resonance line produced by transition from the first excited state to the G.S is usually the most intense (called raie ultime).

He I line is at 584Å or 21.22 eV and He II line at 304 Å or 40.8 eV.

Turner and Jobory (*J. Chem. Phys.* 1962, 37, 3007) introduced the He I resonance line in 1962. He II line was first used by Price and co-workers in 1970 (*Potts, A.W. Lenpka, H.J Streets D.G. and price, W.C. Phil. Trans Roy. Soc. London A, 1970, 268, 59*).

He I and He II

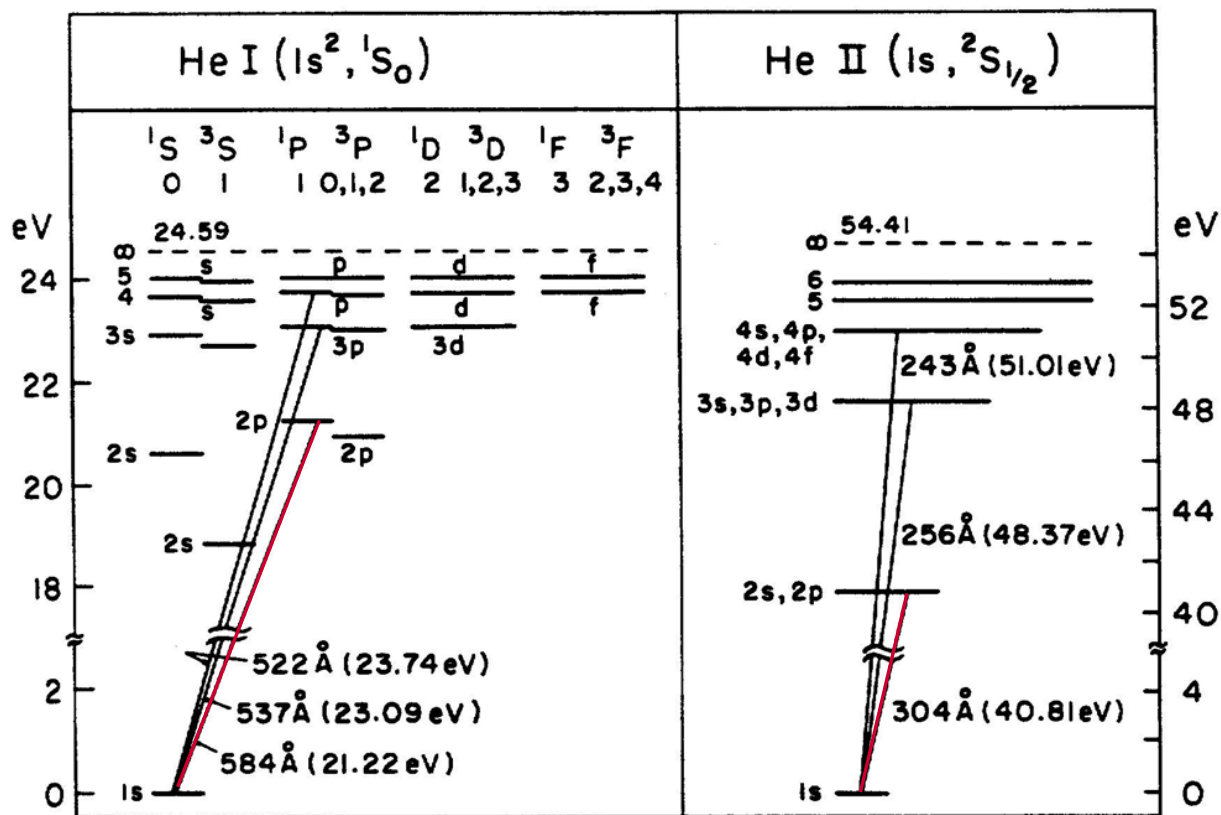

Grotian diagram for He I and He II showing the strongest resonance lines (584 Å, 98% of the emission intensity, the other lines present in a He discharge are 537 Å, 522 Å and 304 Å which can have intensity of the order of 2 % of the 584 Å line.

Photoemission from Valence Bands

Photoelectron spectroscopy is the most powerful and versatile technique to study the *electronic structure* of the valence bands in atoms, solids and molecules (ionization energy of molecules, HOMO). This PE process depends on parameters such as:

Emitted electron parameters

Kinetic energy

Emission angles

Spin polarization

Incident photon parameters

Photon energy ($h\nu$)

Angle of incidence

Polarization

Key Aspects of Valence Band PE

How does the electron Density of States (DOS) relate to the observed emission?

1. XPS with $h\nu > 1000$ eV the electron emission is a good reflection of the density of states (weighted by the transition rate across the VB).
2. At low photon energies ($h\nu < 50$ eV) as in UPS the situation is more complex but richer in information.

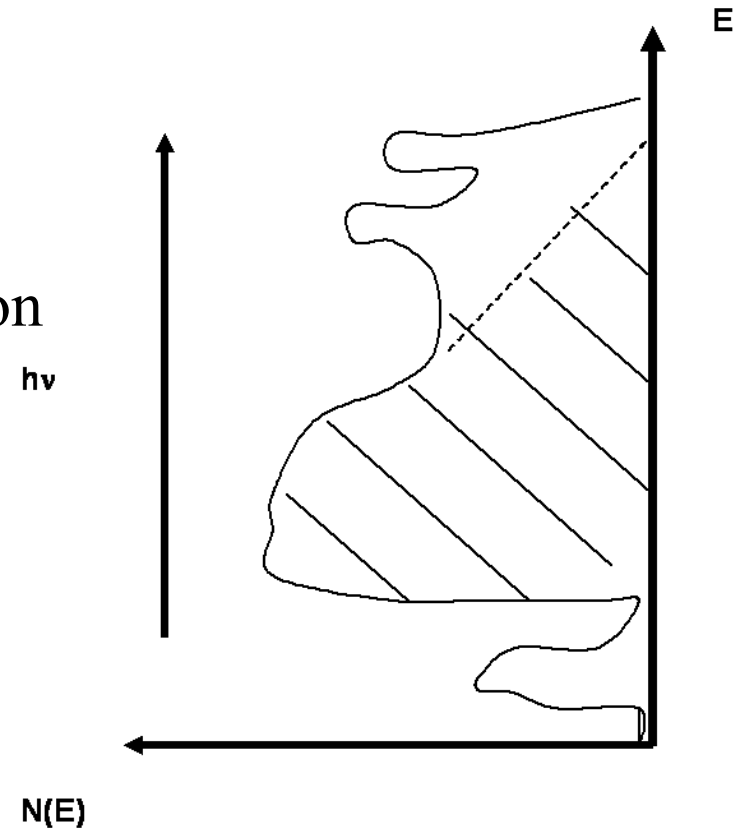

Three Step Model

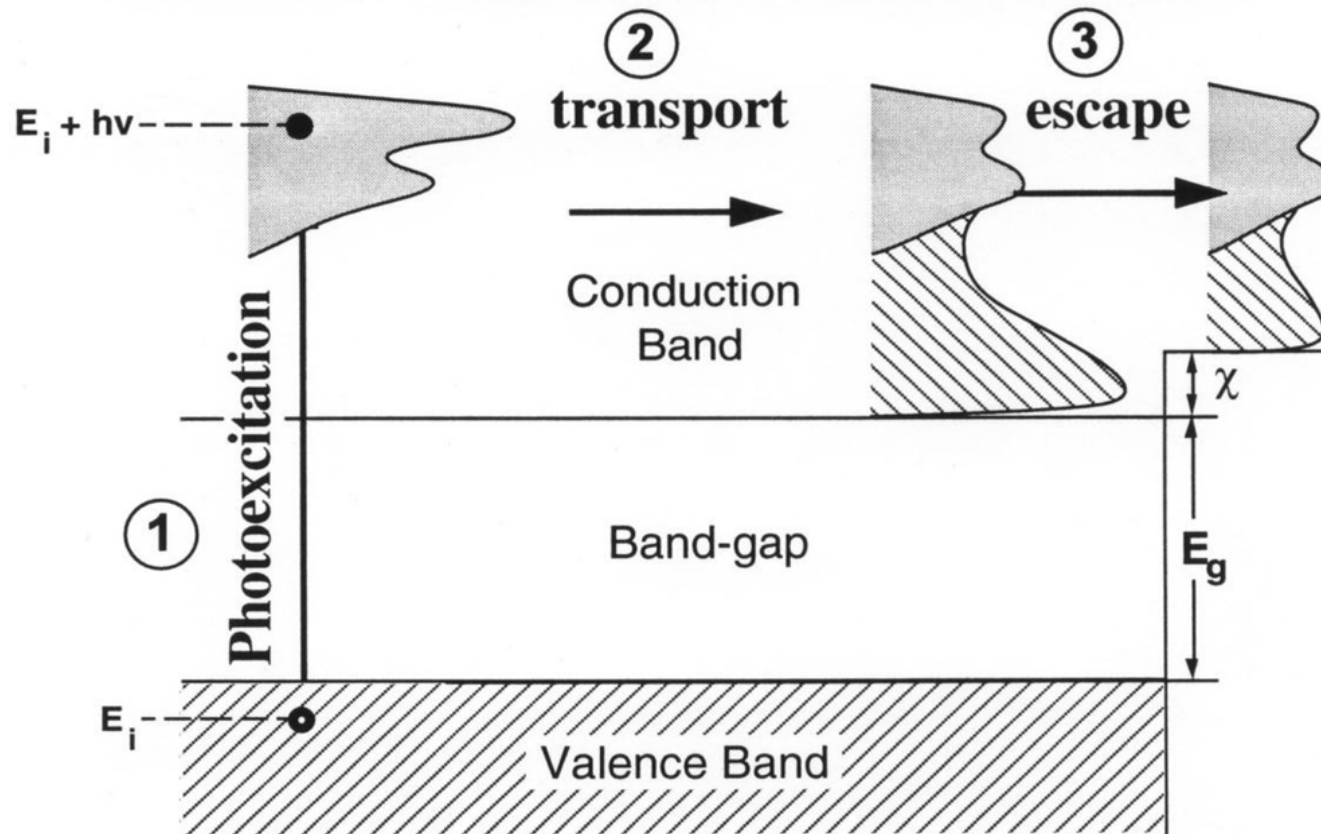

This model assumes that the energy distribution curve is given by

$$N(E) = AN_0(E)L(E)T(E)$$

$N_0(E)$: energy distribution of the electrons in the solid after photoexcitation.

$L(E)$: characteristic transport length of the excited electrons describing the propagation to the surface (closely related to the electron mean free path).

$$L(E) \approx l(E) / \alpha(h\nu) \text{ (transport length of excited electron escaping into the vacuum without scattering)}$$

$\alpha(h\nu)$: absorption coefficient (incident photon intensity falls to $1/e$ value within a distance $1/\alpha$, and $l(E)$: electron escape depth.

$T(E)$: probability for emission into vacuum (smooth function which does not introduce any structure to the spectra).

Inelastically scattered electrons will still have enough energy to escape into vacuum and be detected as secondary electrons to form the **background**

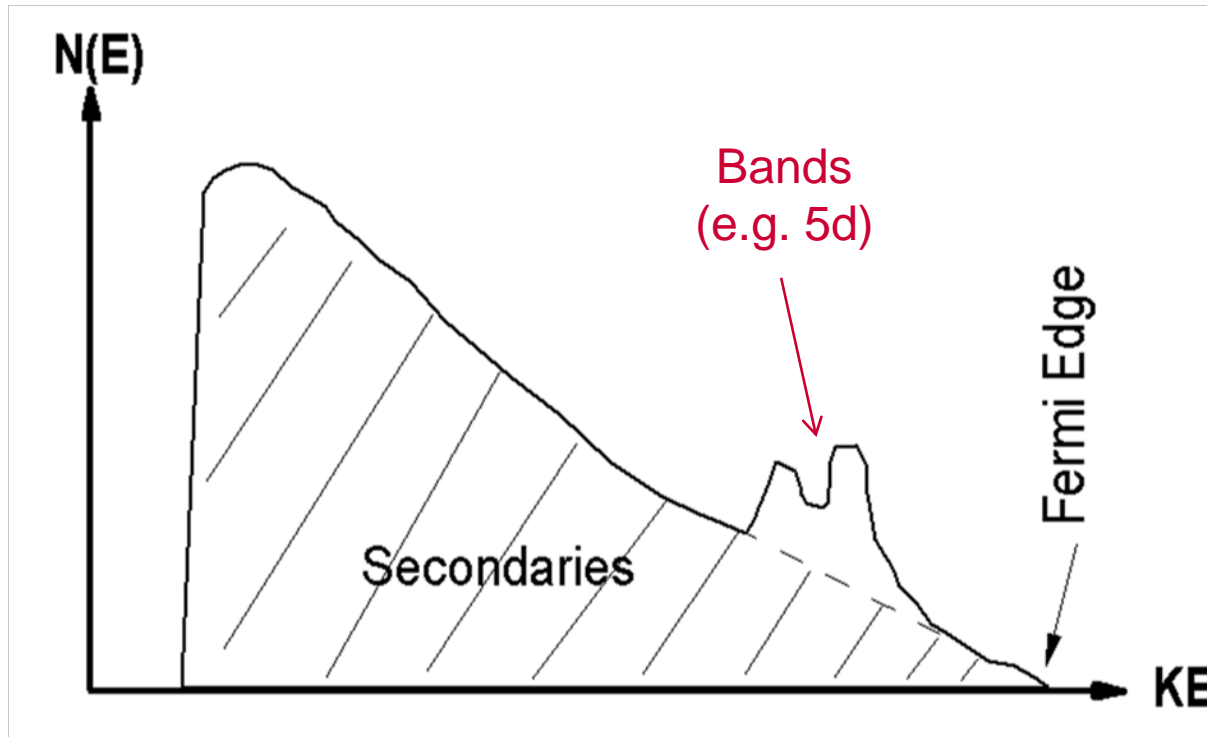

There is NO well-defined boundary between valence states and core levels. Valence states can extend to 10-15 eV down in binding energy and core levels can be as shallow as a few eV.

In general, the boundary can be found around 10-15 eV (BE).

Levels with higher BE → → core like

Levels with lower BE → → valence band like

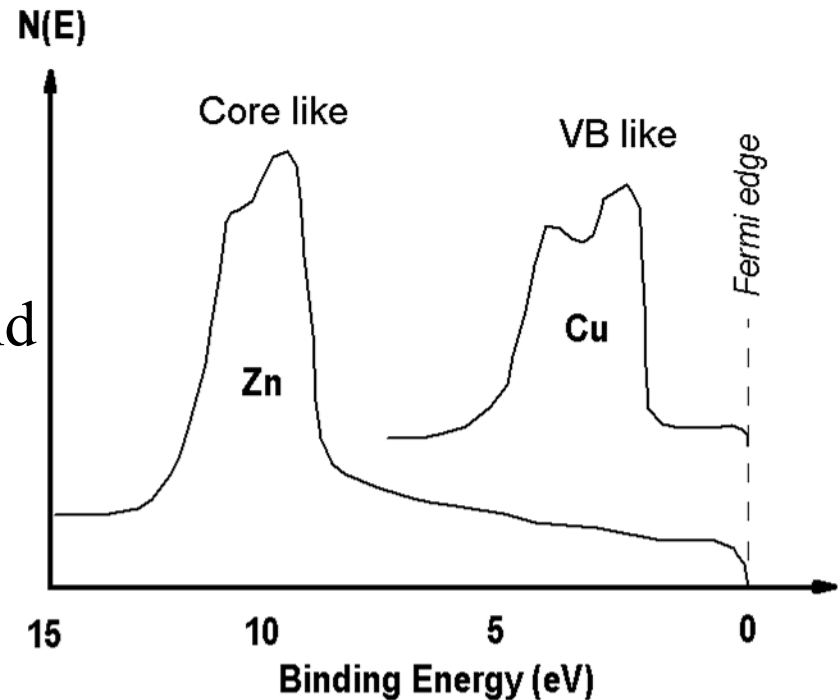

Similarly, there is NO well-defined photon energy ($h\nu$) above which the excited valence band (VB) starts to resemble the density of states.

However, for $h\nu > 40$ eV, the excited VB generally converges to a same spectrum as shown in this example for gold.

The UPS spectrum changes drastically for energies of 15 to 30 eV but looks very much the same from 40 eV to 90 eV

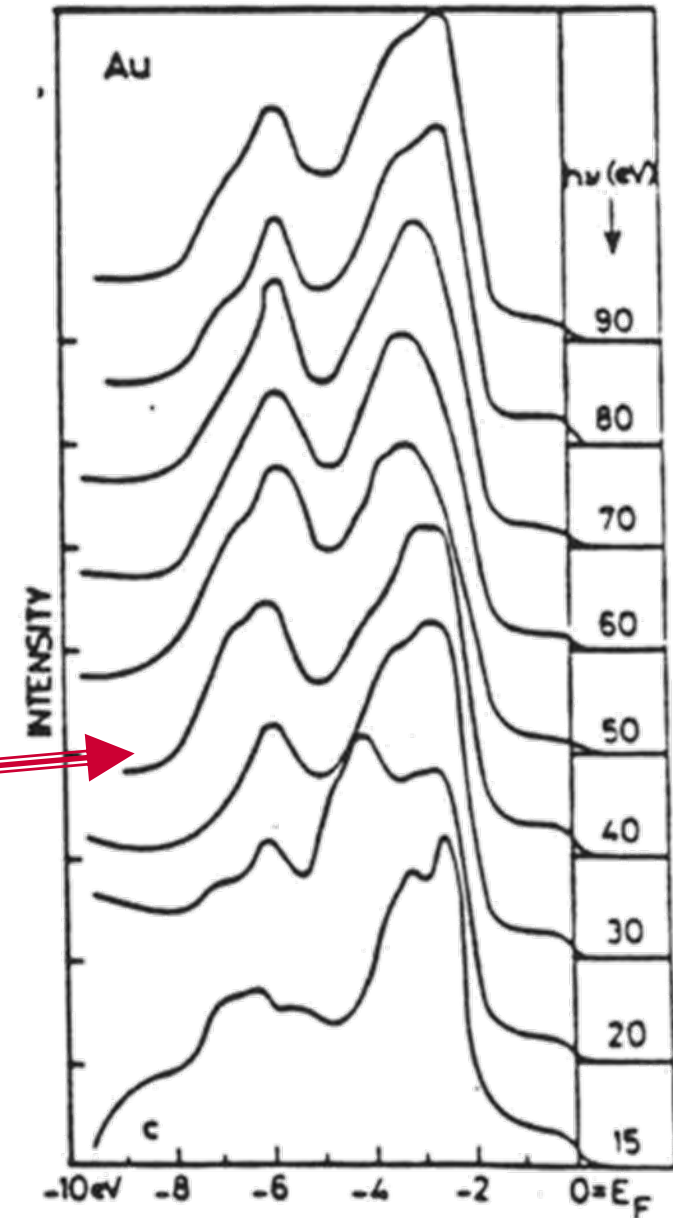

Angle Resolved Photoemission

In XPS to enhance the surface signal one can change (decrease) the angle of electron emission relative to a solid surface ($d = \lambda \sin \theta$). We can use this method in UPS to get the dispersion relation (E vs k: wavevector)

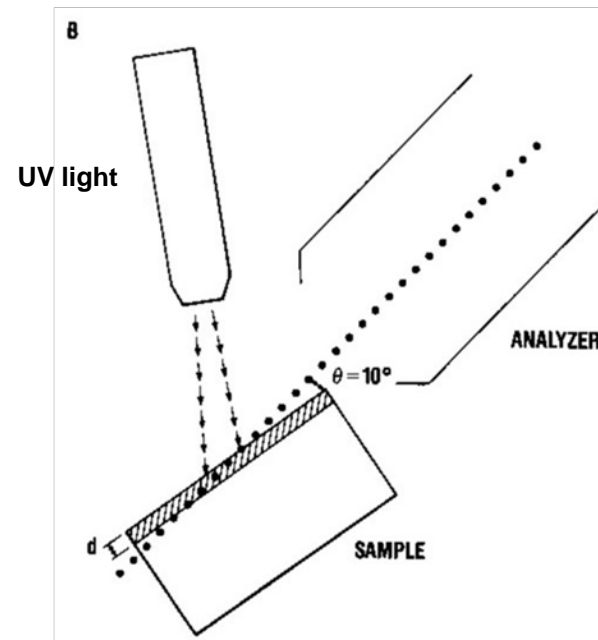
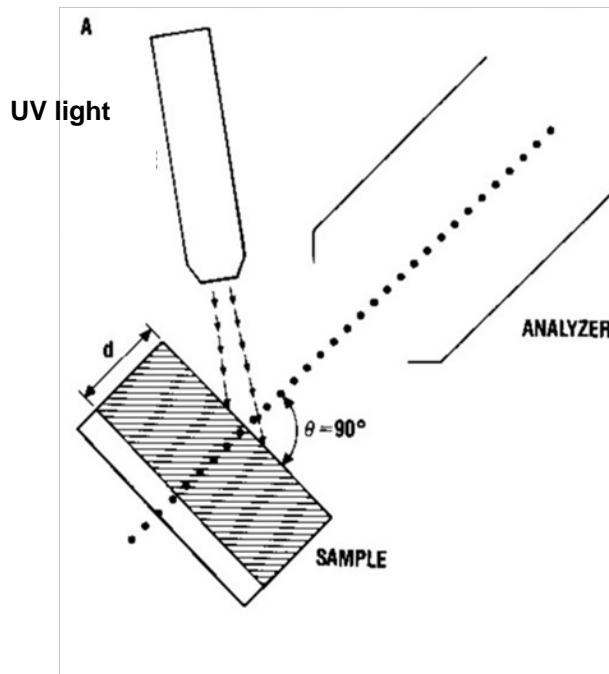

- Angle resolved PE has found wide spread in electron spectroscopy. The goal here is to determine the energy, E , and the electron momentum, $\hbar k$, of the emitted photoelectron outside the solid, and to relate to the energy dispersion, E vs k , inside the solid.
- Angle – resolved photoemission has emerged as the most direct technique to determine this relation experimentally.
- For PE we have very simple conservation laws:
Energy conservation: $\mathbf{E}_i = \mathbf{E}_f - h\nu$
Momentum conservation: $\mathbf{k}_i // = \mathbf{k}_f //$

The momentum perpendicular to the surface is not conserved (periodicity is broken). For all practical purposes, we can ignore the momentum due to the photon

$$E = \frac{(\hbar k)^2}{2m}$$

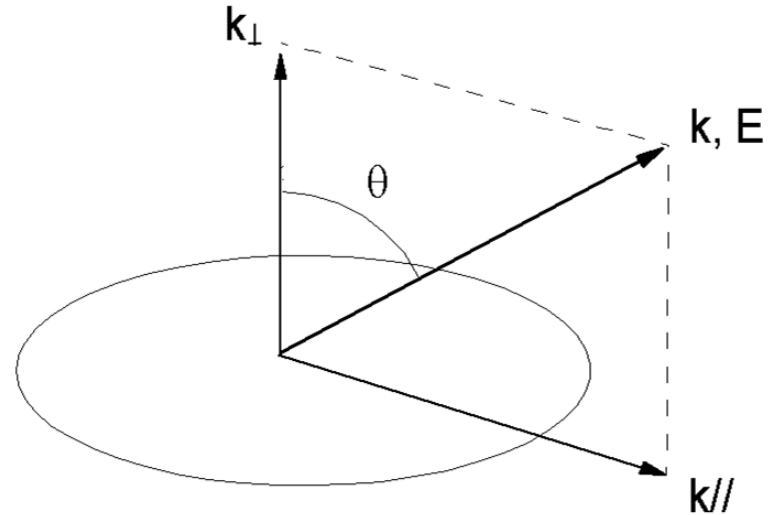

The knowledge of E and then $|k_{\perp}\rangle$ allows one to get the band structure diagram $E \rightarrow \mathbf{k}$ (wavevector).

If we consider the simplest case of a 2D material where all interactions between the layers can be neglected and apply the conservation laws, we can write $k_{//}$ as follows:

$$\mathbf{p}^2 = p_{//}^2 + p_{\perp}^2$$

Knowing that $p_{//} = (\mathbf{k}_f)_{//} = (\mathbf{k}_i)_{//}$

$k_{//}$ can then be rewritten as

$$k_{//} = \frac{\sqrt{2mE}}{\hbar} \sin \theta$$

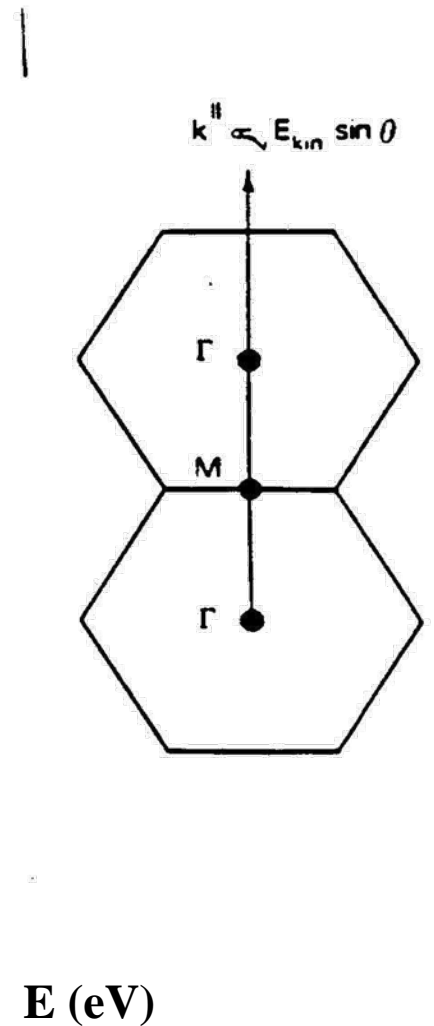
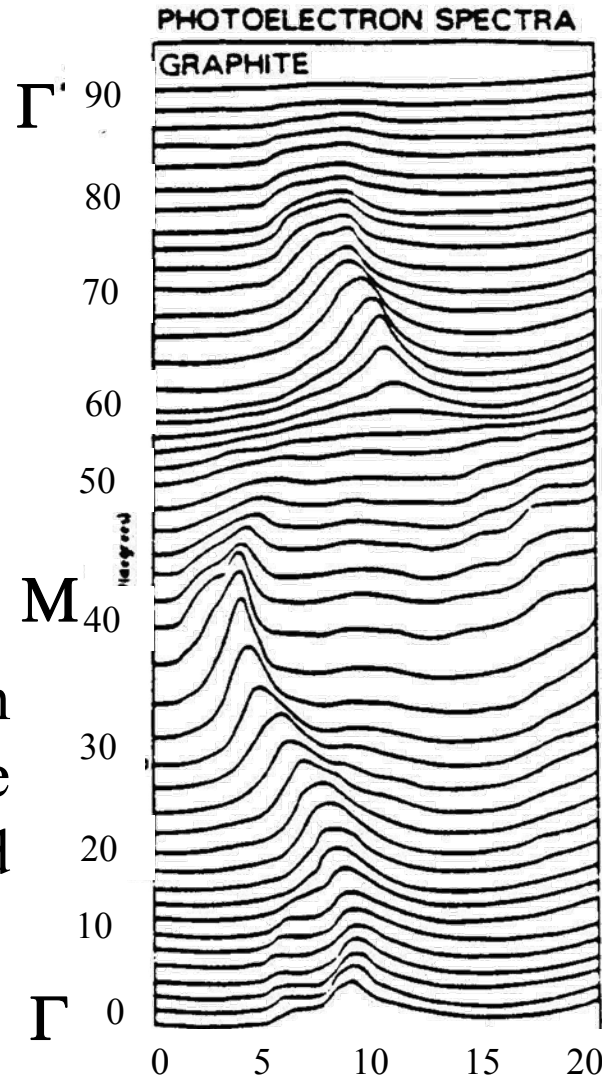

It is therefore easy to obtain E vs k by simply varying the detection angle θ and determining E .

Symmetry points and axes of the Brillouin zones of the fcc (a) and bcc (b) lattices. The zone centers are Γ .

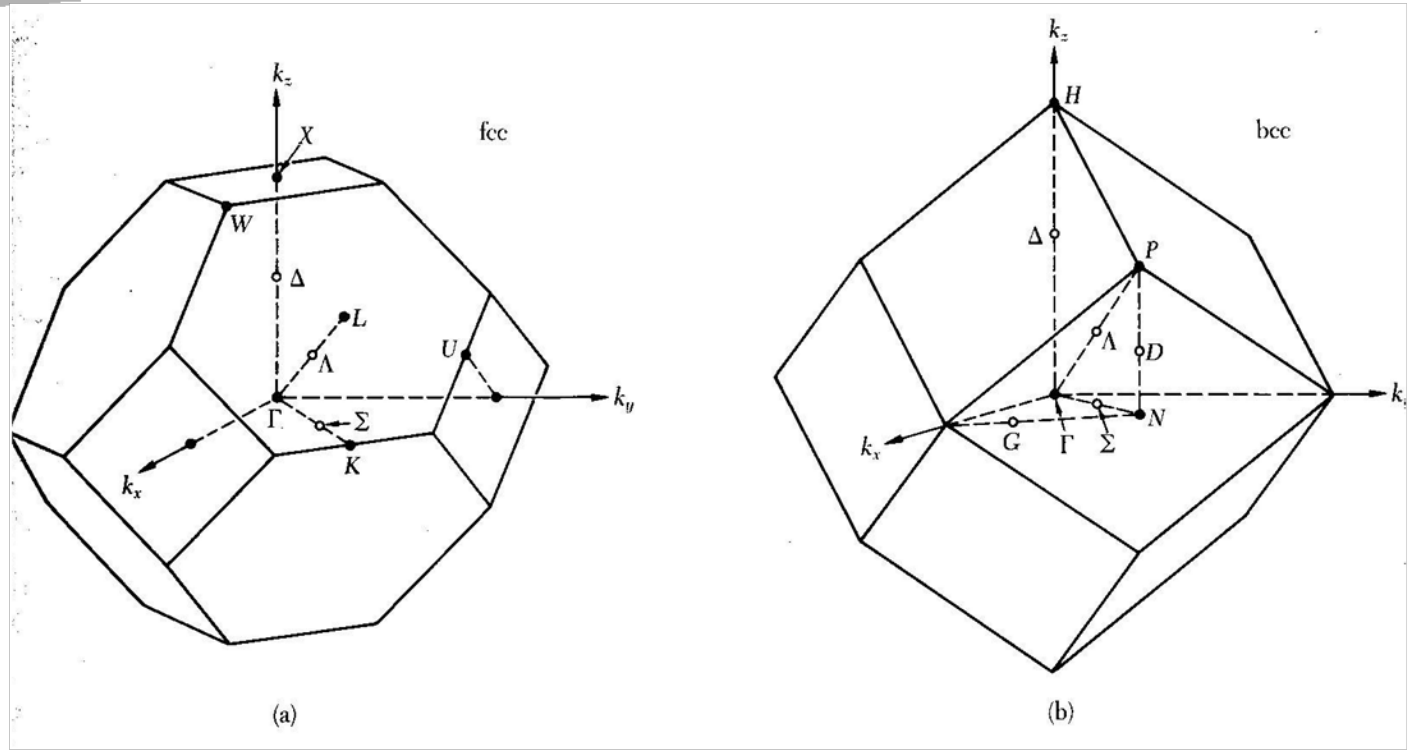

In (a) the boundary point at $2\pi/a$ (100) is X; the boundary point at $2\pi/a$ ($1/2, 1/2, 1/2$) is L, the line Δ runs between Γ and X.

In (b) the corresponding symbols are H, P and Δ .

Types of Ionization Energies

Adiabatic = minimum energy to ionize a molecule to a specific state of the ion. Only from a vibrational resolved photoelectrons band whose $v' = 0$ peak is clearly observed.

Vertical = energy to ionize the molecule to a vibrational level of the ion which has the maximum probability of photoionization (Frank-Condon factor).

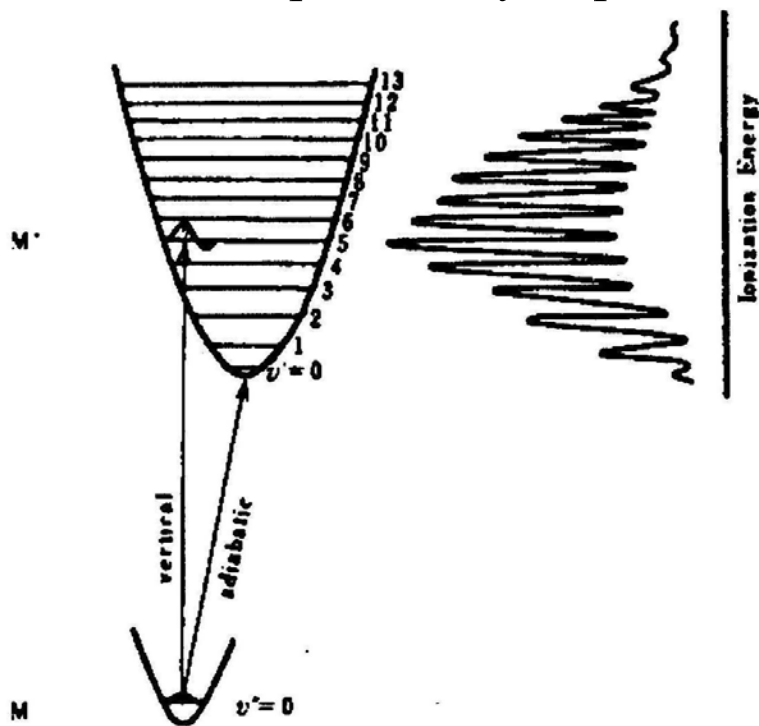

Potential energy curves with vibrational levels showing the origin of the vibrational structure of the photoelectron band. The vertical and adiabatic ionization energies are indicated

Photoionization Process

In general, however the photoionization process to produce state i of the positive ion (M^+) is described by the following expression:

$$I_i = h\nu + K_i \quad \mathbf{I \text{ is the ionization energy}}$$

Case I: Metals

UPS could be used to determine the work function of metal. By measuring the width of the emitted electrons (W) from the onset of the secondary electrons up to the Fermi edge and subtracting W from the energy of the incident UV light, $h\nu$, the work function ϕ_m is then given by

$$\phi_m = h\nu - W$$

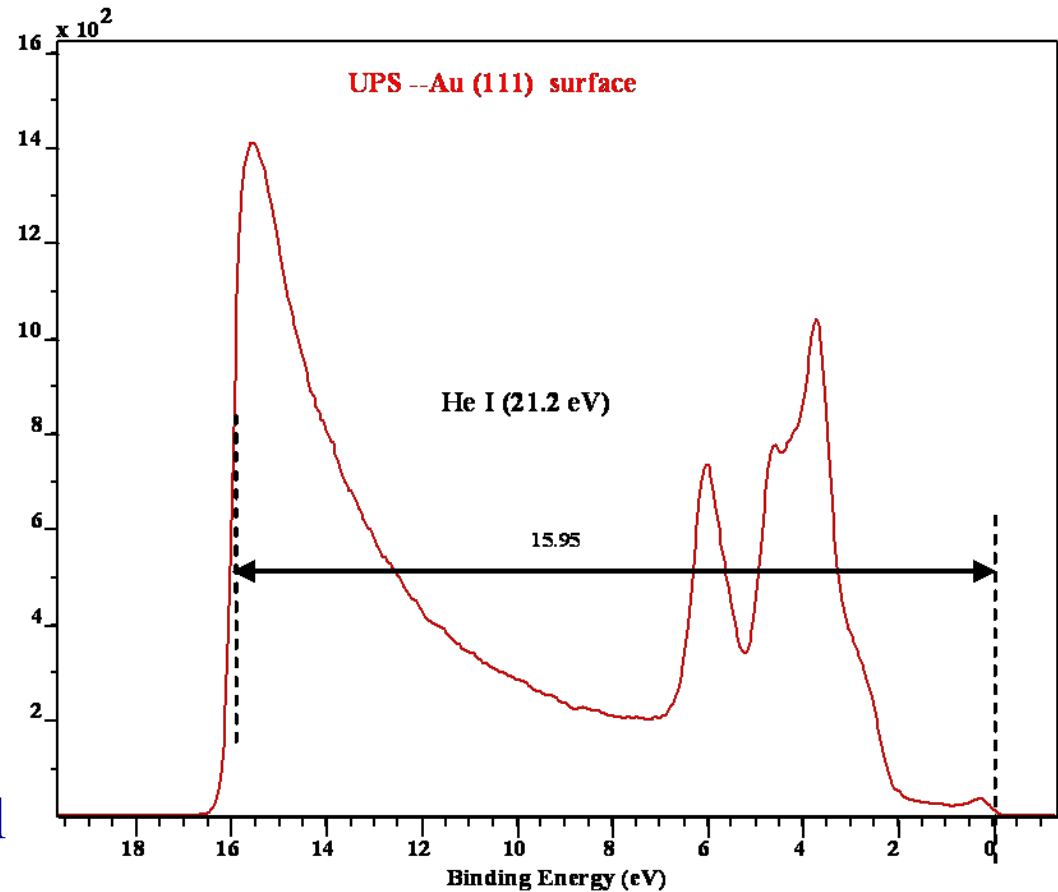

Example: Au (111) single crystal

$W = 15.95$ eV, Photon energy $h\nu = 21.2$ eV

$\phi_m = 21.2 - 15.95 = 5.25$ eV ± 0.15 eV (resolution of the instrument)

Literature value 5.3 eV (CRC)

Case II: Molecular systems (*molecular film adsorbed on metal*)

Not so simple in case of molecules

Why?

1. Charge transfer across the interface (expected for the combination of strong acceptor-low work function or strong donor-high work function).
2. Redistribution of electron cloud (polarization of the electron cloud attracted by the image charge formed in the metal).
3. Interfacial chemical reactions (well known case for small molecules like CO and benzene on clean metal surfaces).

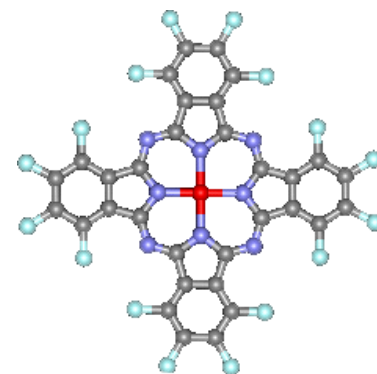
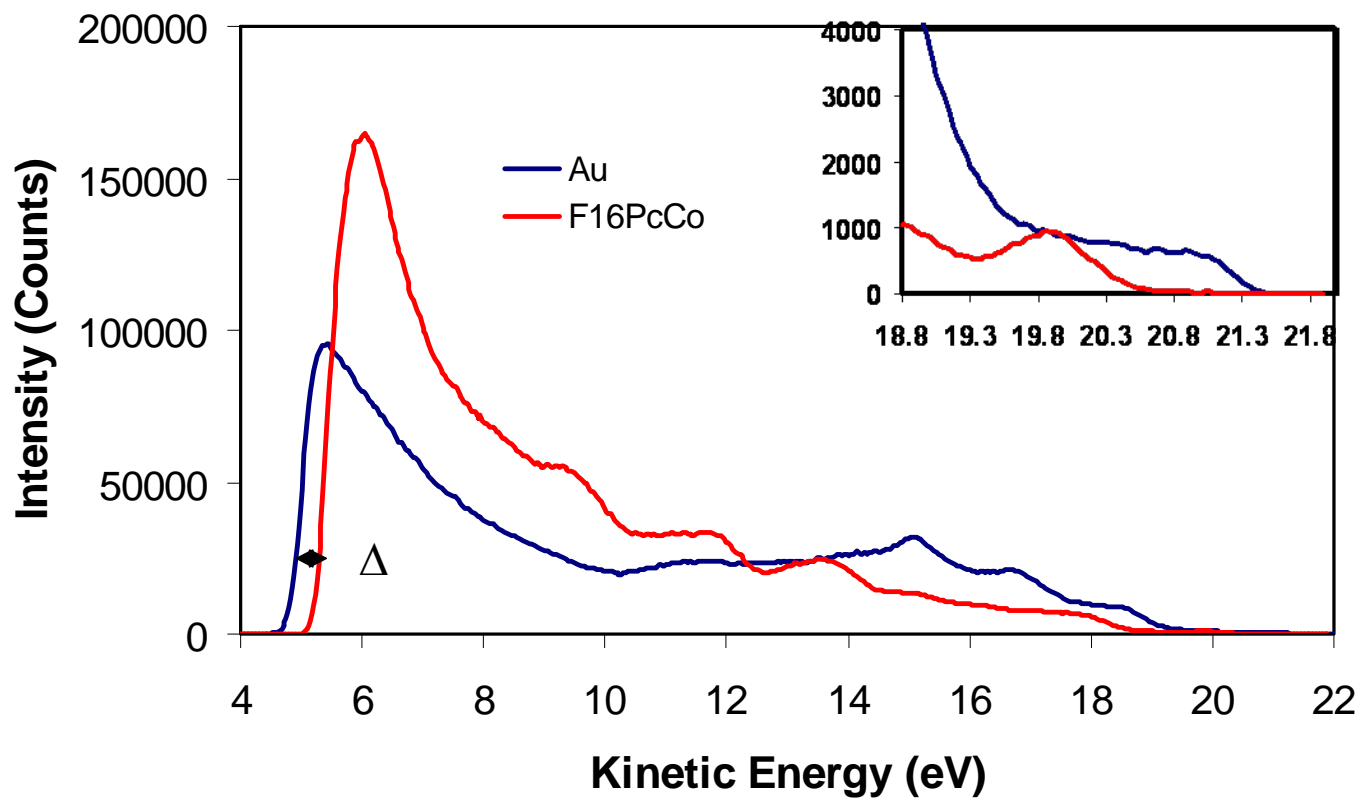

A vacuum shift $\Delta = 0.5$ eV was measured at the lower KE side of the UPS spectrum obtained for the compound.

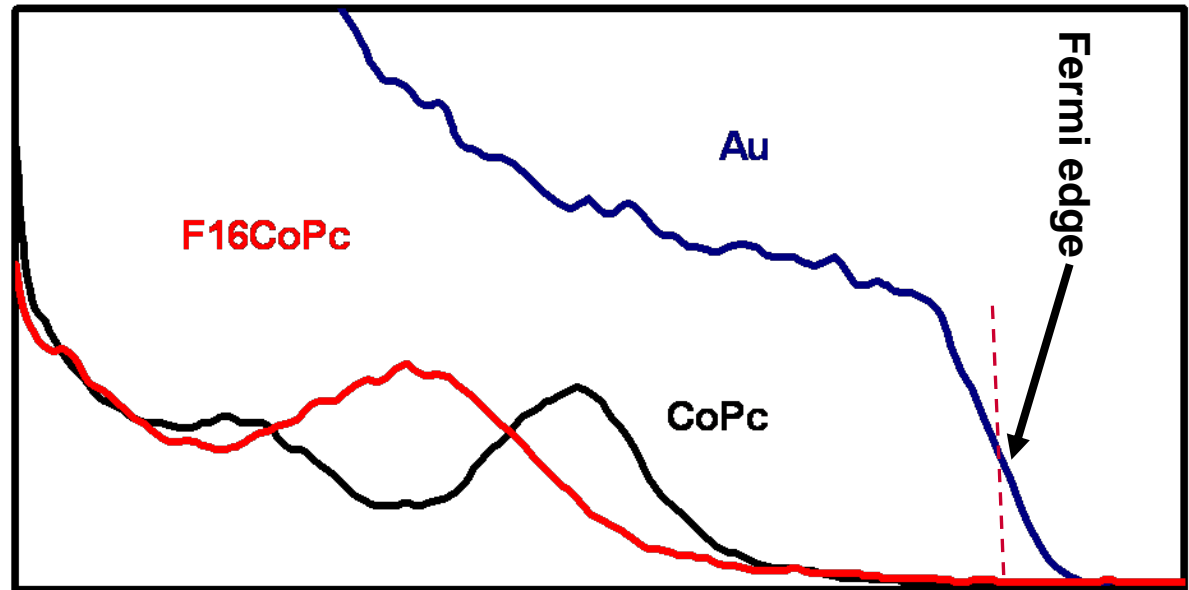

UPS data shows the first ionization energies for CoPc and F₁₆CoPc (HOMO) adsorbed on Au surface. A difference of 0.5 eV was measured between CoPc and F₁₆CoPc compounds. This is due to the high electro-negativity of fluorine (highest withdrawing electron power than of H) therefore the electrons are tightly bound → need more energy (higher KE).

Energy relationships in UPS

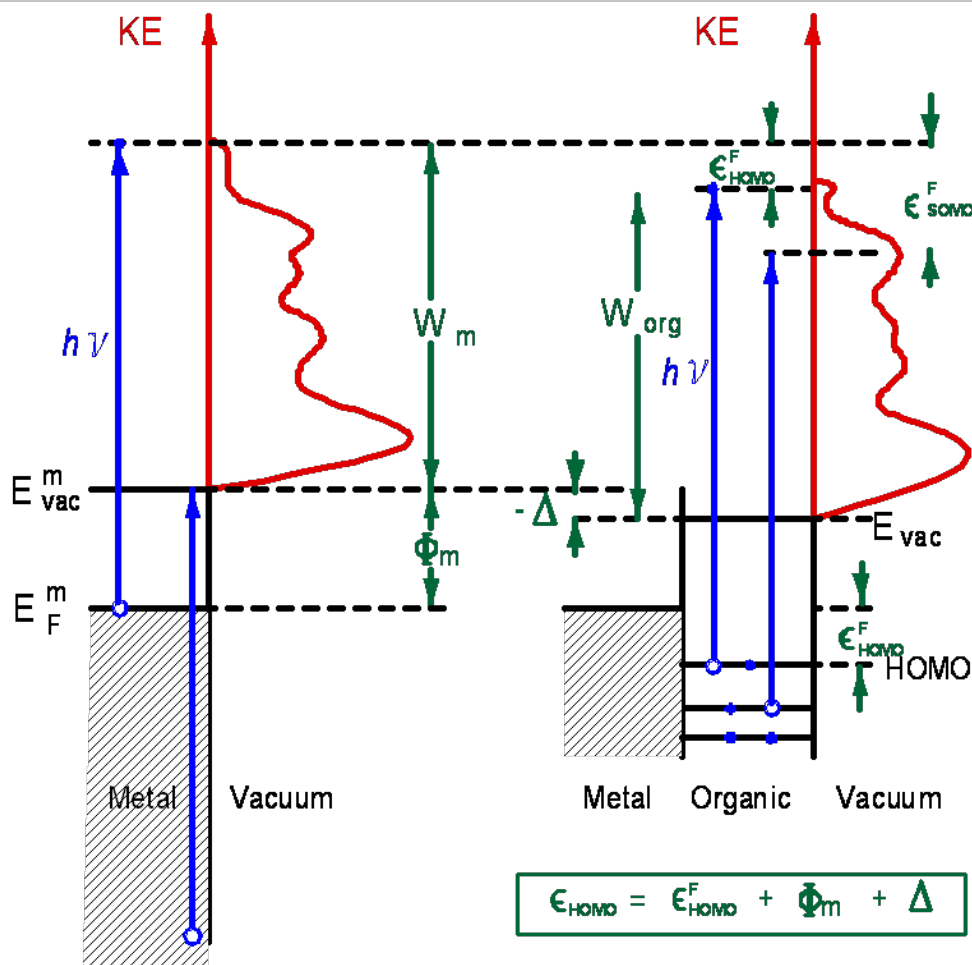

Energy relationship cartoon, left for Au, right for an organic layer deposited on the metal substrate.

Δ : vacuum shift (presence of a dipole moment at the interface)

ϵ_{HOMO} : energy of the highest occupied molecular orbital (molecule) or Valence band maximum (VBM) for semiconductors

Organic thin-film transistors (OTFTs)

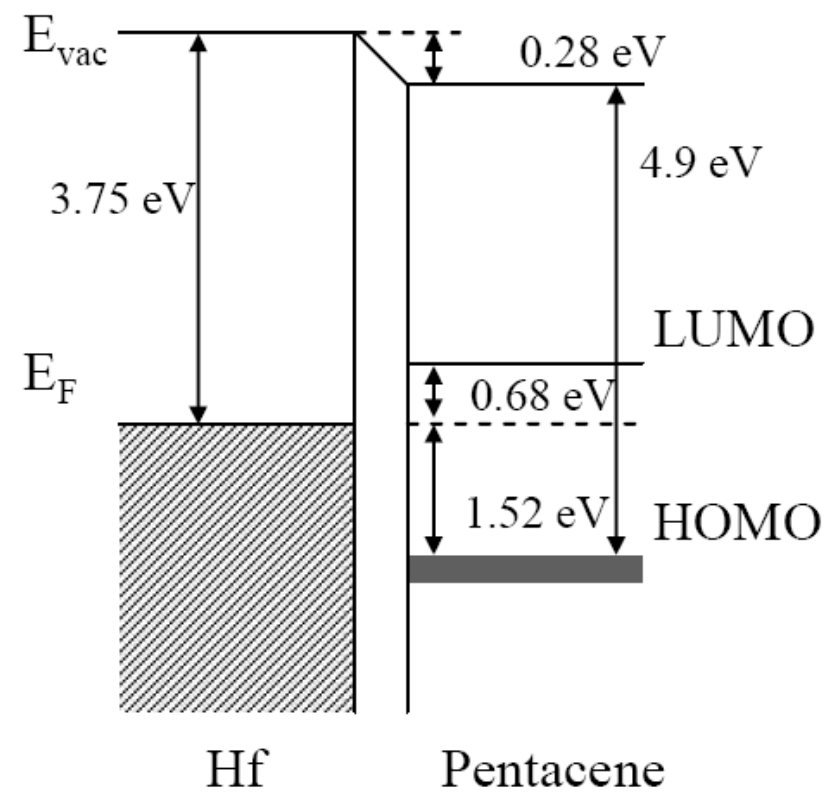
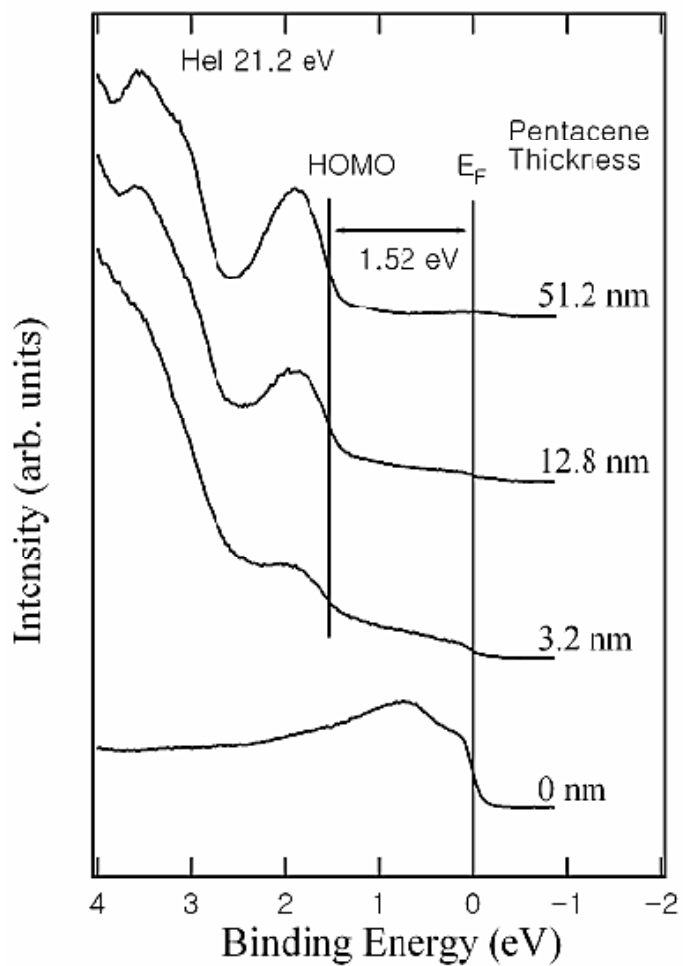

$\Delta = 0.28$ eV: interfacial dipole at the interface between pentacene and Hf.

Typical UPS spectrum for a n-type SC

- The important surface parameter for semi-conductor is the electron affinity χ_s .
- This parameter is defined as the difference in energy between an electron at rest outside the surface and an electron at the bottom of the conduction band just inside the surface

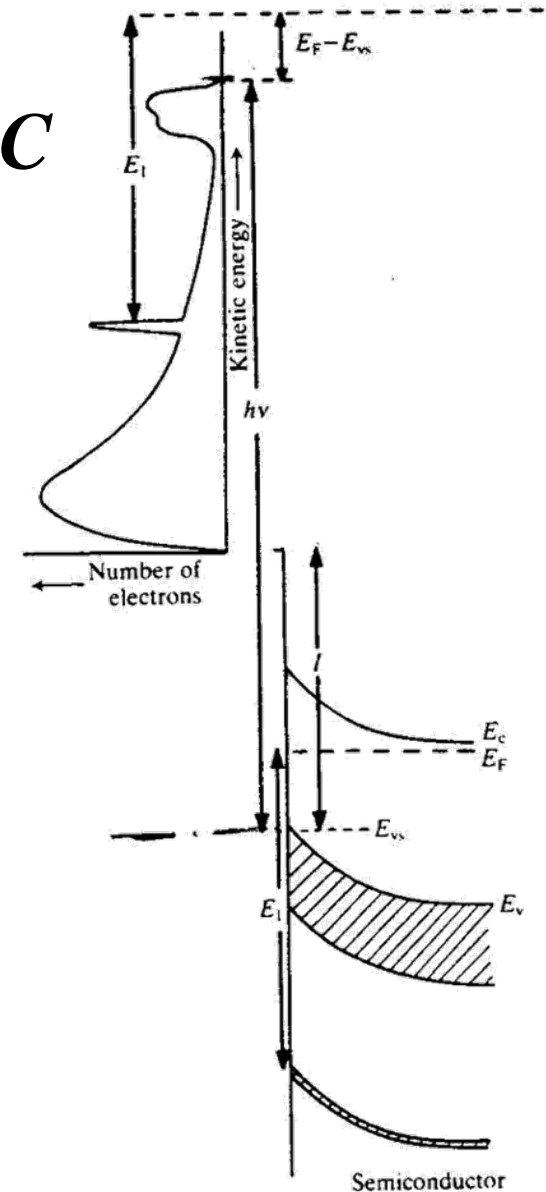

Problems associated with UPS

At the UV energies the background of degraded electrons severely distorts the spectrum near the work function cut-off.

The cross-section of rare earth 4f and actinide 5f states are small.

The shape of the PE spectrum is modulated by the unoccupied density of states.

XPS has a lower resolution and lower rates of data acquisition but it is insensitive to the *empty density of states* providing a clear view of the disposition of the occupied electronic orbital.

Behavior of *an electronic orbital* in different chemical state of the outer electrons of Au [Xe] 4f¹⁴ 5d¹⁰ 6s¹ in two different systems.

Example 1: Metal Au. The 5d electrons form a broad band between 2-8 eV and the 6s electron is seen between 2eV and the E_F cut-off. But the 6s band extends to much greater BE, it is strongly hybridized with the 5d band.

Example 2: CsAu, a red transparent semiconductor with a 2.6 eV band gap (with a large electronegativity), the Au becomes a negative ion with a filled $6s^2$ shell. This results in a $5d^{10}$ shell that is a core like spin-orbit doublet with 1.5 eV splitting, the 6s electrons constitute the VB and lies about 3eV below E_F

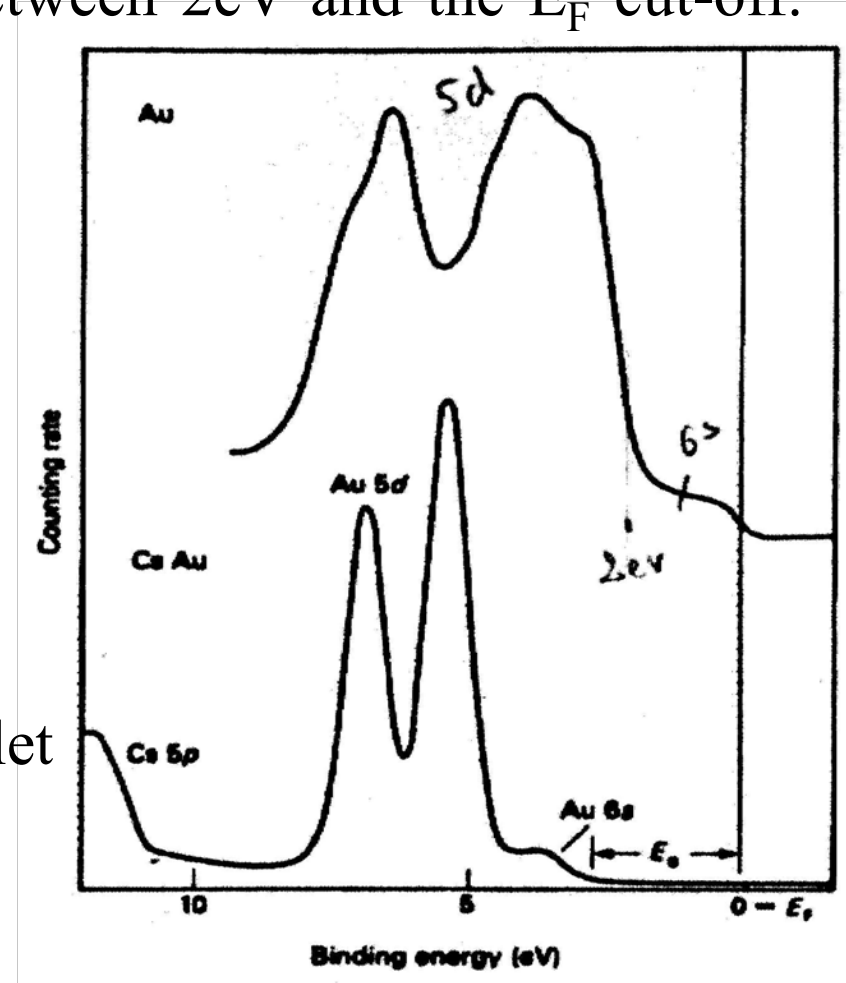

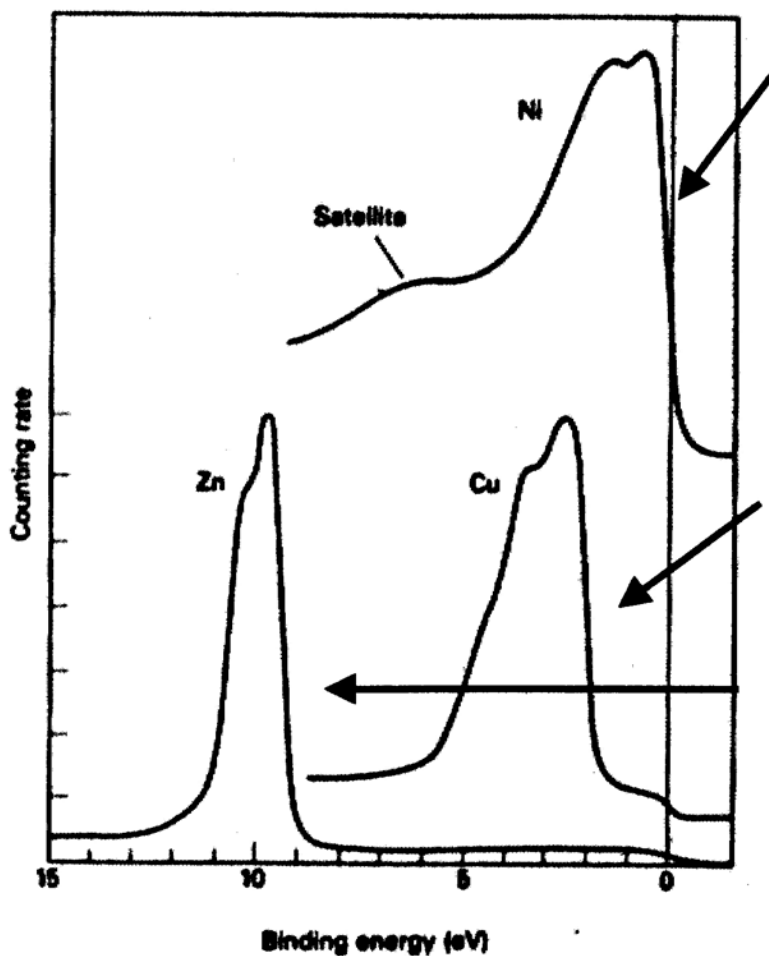

d band is partially filled, it intersects the E_F .

d^{10} shell \rightarrow the d band falls well below the E_F and show a band like character.

d^{10} shell \rightarrow the d band is 10 eV below E_F and therefore show core-like character.

Shown here are UPS spectra of some d-group metals (Ni, Cu, Zn).

The transition from valence-like to core-like behavior with increasing atomic number is clearly seen

Photoelectron data do not correspond to the total one-electron density of states because: (1) Lifetime broadening, (2) Difference in cross-section and (3) Multi-electron excitations.

Lifetime broadening

The VB spectrum is distorted by the hole-lifetime width which changes rapidly with BE. At E_F no lifetime broadening is in evidence but at the bottom of the CB it may be substantial $\rightarrow\rightarrow$ Lorentzian tailing of the band edge coupled with a rising Plasmon loss-tail makes it difficult to define the bottom of the CB.

Ex: the bottom of the 4s band in Cu is not detectable in PE (at 7.8 eV)

Difference in cross-section

A good example is ReO_3 , a copper-colored conductor. The electronic configuration of Re^{6+} is $[\text{Xe}] 4f^{14} 5d^1$. Experiment + theory agree on the 5d CB below E_F well separated from the O 2p VB.

In general *XPS data for the VB* do not agree with the calculated total DOS. This reflects the *d*-admixture into the VB and a disparity in the cross-section which favors Re 5d over O 2p by a factor 30

(*p-derived* features are generally suppressed in XPS and strong *d-hybridized* features enhanced).

VB peak at 3.5 eV, which is largely of O 2p character, is almost totally suppressed while the lower part of the VB and the CB at 1 eV are greatly enhanced.

In UPS the situation is generally reversed and the photoelectric cross-section is essential for the interpretation of VB spectra.

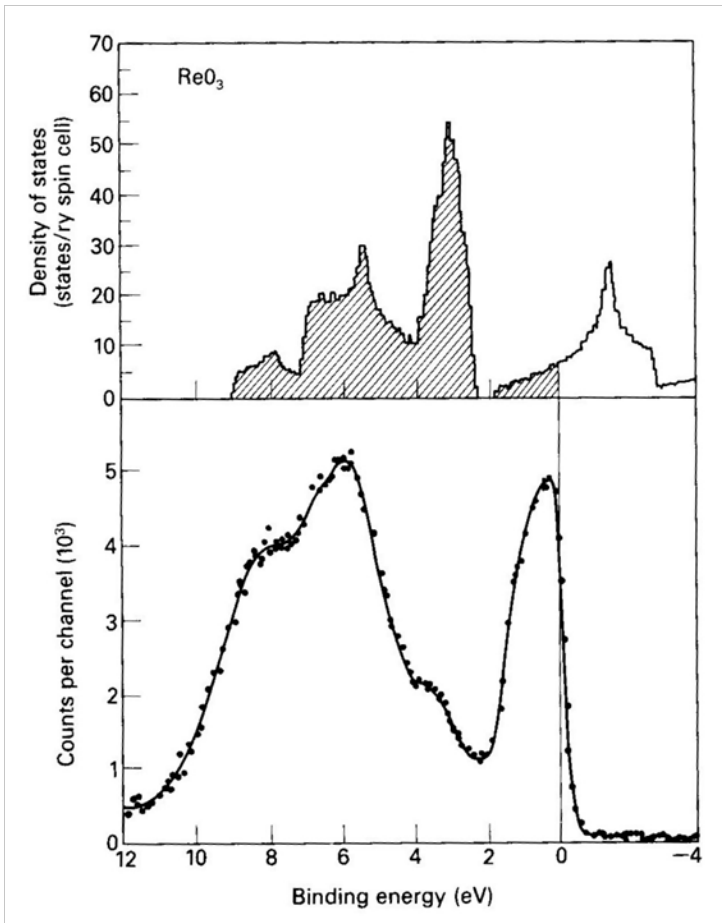

The cross-section for PE of a system in state i by a photon of energy $h\nu$ leaving the system in a final state f consisting of a photoelectron of energy ε plus an ion in state j is given by:

$$\sigma_{i,j}(\varepsilon) = \left(\frac{4\pi^2 \alpha a_0^2}{3g_i} \right) (\varepsilon + I_{i,j}) |M_{i,j}|^2$$

Where α is the fine structure constant $1/137$, a_0 is the Bohr radius, g_i is the number of degenerate sublevels of initial discrete state, $I_{i,j}$ the ionization energy (expressed in Rydberg). Using the dipole approximation which is good to 1% at $h\nu = 800$ eV and 5% at $h\nu = 2000$ eV. The dipole matrix element becomes

$$|M_{i,j}|^2 = \frac{4}{(\varepsilon + I_{i,j})^2} \sum_{i,j} \left| \langle f | \sum_{\mu} \nabla_{\mu} | i \rangle \right|^2 = \sum \left| \langle f | \sum_{\mu} r_{\mu} | i \rangle \right|^2$$

Photoionization cross-section reduces to one of finding initial and final state wave function.

In the case of Xe and gold studied by Manson (*Manson, S.T. Topics in Applied Physics V 26, p135*), the ε_F wave function for Xe has a very small amplitude in the core region so that the overlap with the Au 4d is quite small making $|M_{i,j}|^2$ very small. As the photon energy $h\nu$ increases, the ε_F wave function becomes more penetrating and the dipole matrix element $|M_{i,j}|^2$ and σ increase.

In the case of Au, the cross-section for the 5d- and 5p- states increase drastically for $h\nu < 100$ eV (UPS) and the cross-section for the 4f-state decreases. The situation is reversed at $h\nu > 200$ eV (XPS).

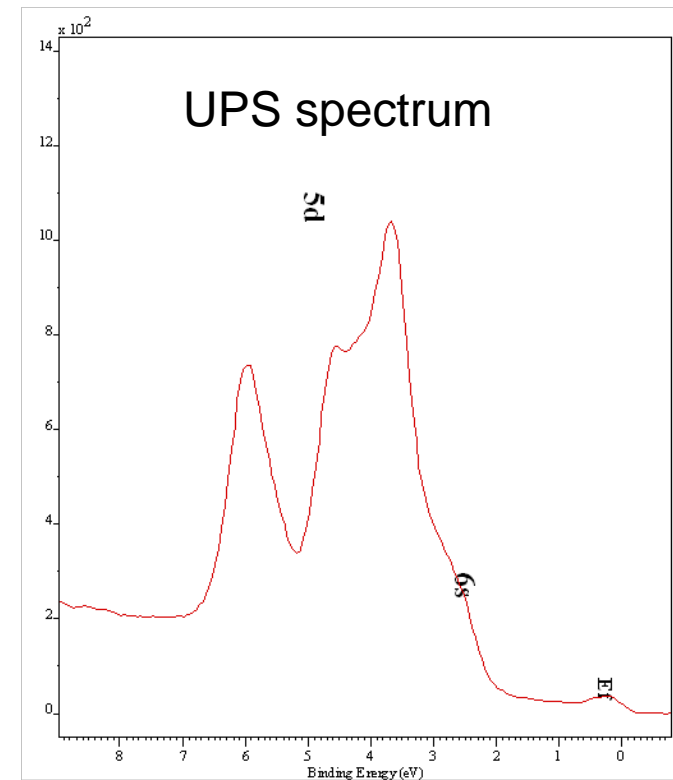
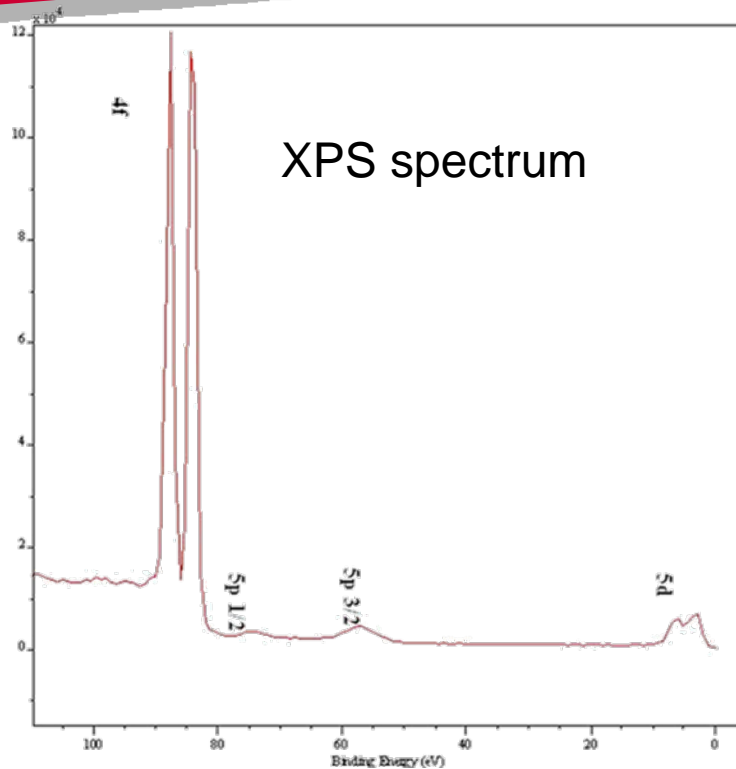

In general, *the energy dependence* of the photoionization cross-section can be exploited to see that some features are enhanced in UPS and others are suppressed. The situation is reversed in XPS

Kennedy and Manson tabulated values of subshell cross-sections as function of energy for rare-gases. (Kennedy, D.J, Manson, S.T. *Physical Review A*, 1972, 5, 227)

Calculated subshell photoionization cross-sections by Lindau and Yeh using one-electron central-filed frozen-core model and first-order perturbation theory.

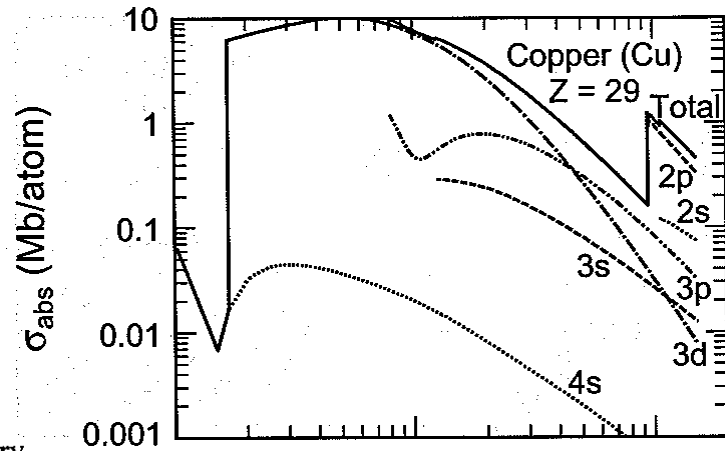
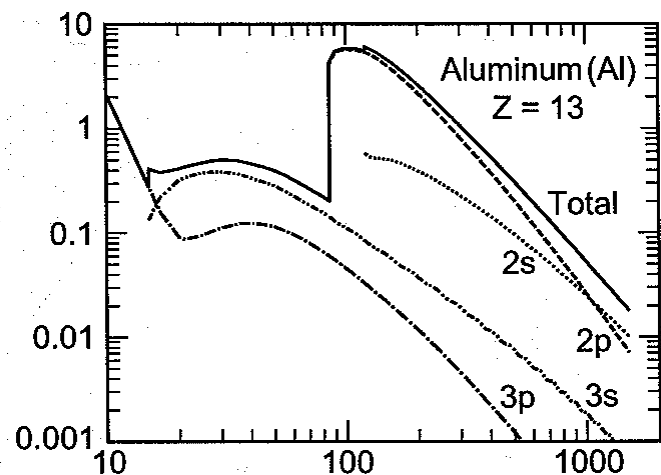
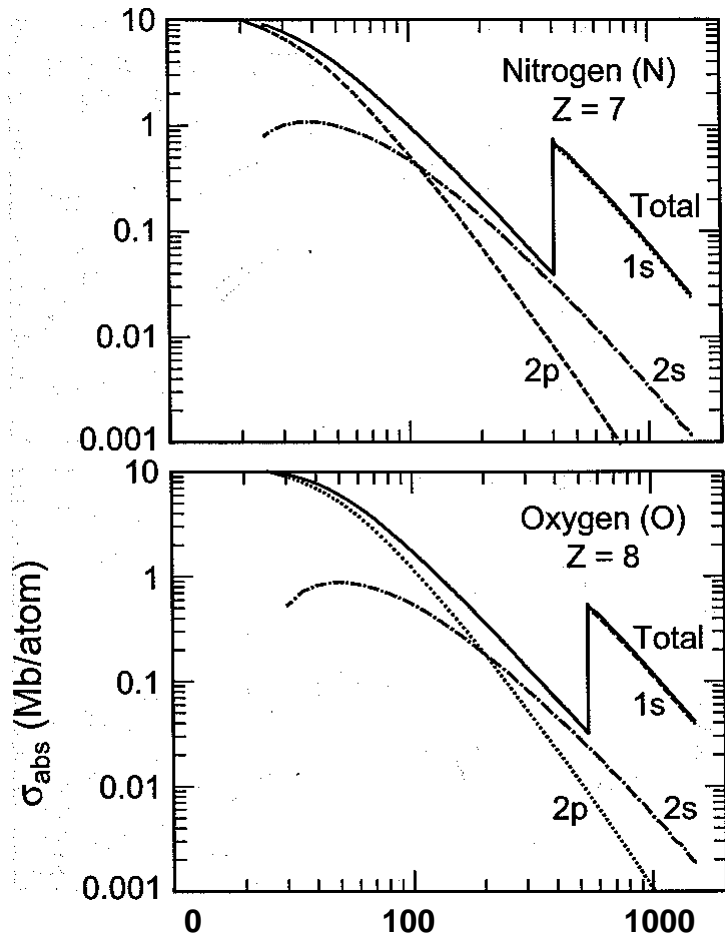

Multi-electron excitation

Peaks may be introduced where none exist in the DOS as a result of multi-electron excitation. No guarantee that an observed feature in the VB region corresponds to a feature in the one-electron density of states.

Shake-up satellites are expected to be weak in the VB, because the relaxation energy associated with the outer shell is much smaller than a core level.

Strong coupling of electrons within a shell allows multiple hole states to be excited through configuration interaction or resonance process.

Example: in Ni a feature 6 eV below the E_F is the result of the multi-electron excitation (satellite).

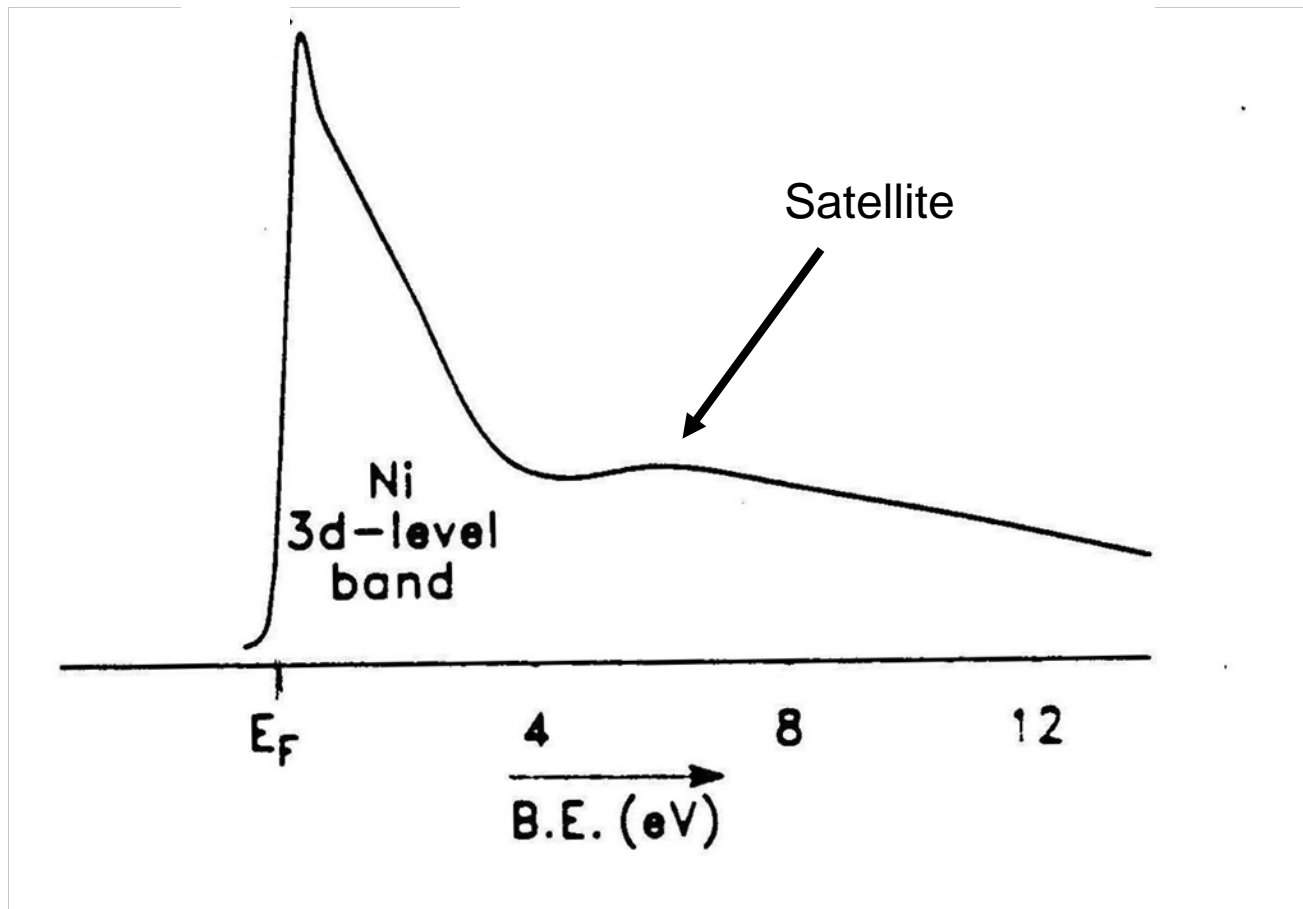

Chemisorption Studies

Based upon a comparison between

1. Electronic levels of gas phase spectra and
2. Chemisorbed spectra.

Information can be obtained on

1. Identification of species
2. Reaction products

Energy level positions can identify orbitals participating in gas substrate bonding

Polarization and photon energy dependence can provide

1. Electron orbital identification
2. Orientation of the chemisorbed species (structural information)

Example: CO molecule in the gas phase (orbitals and UPS spectrum)

Schematic orbital for CO

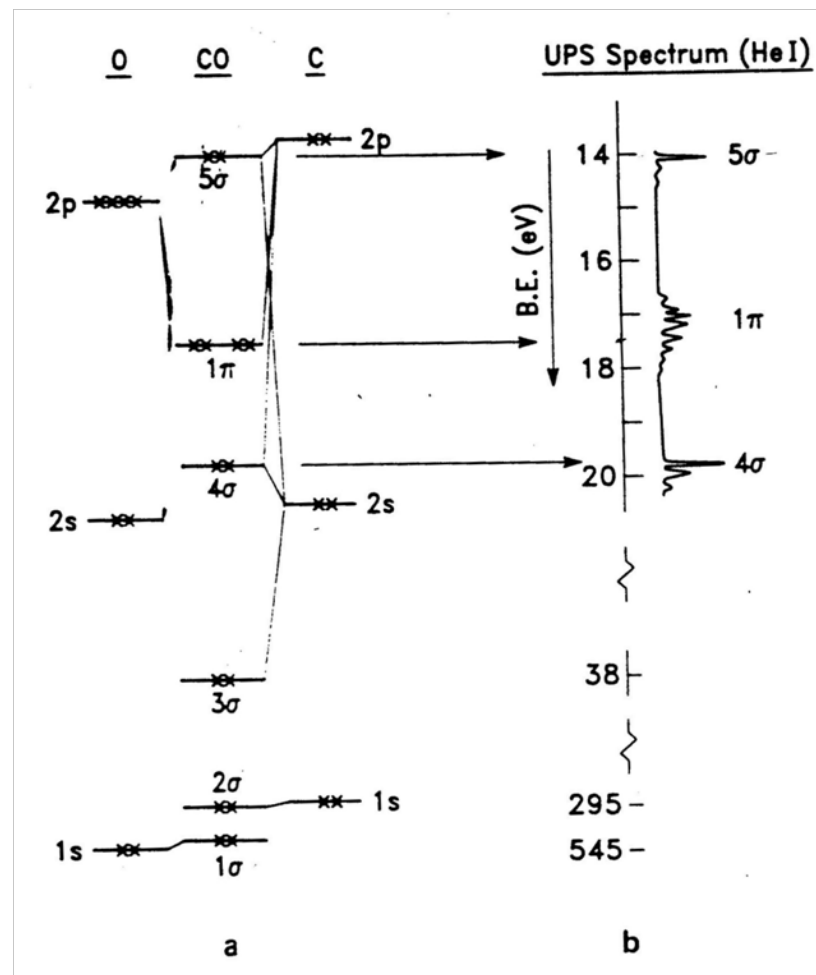
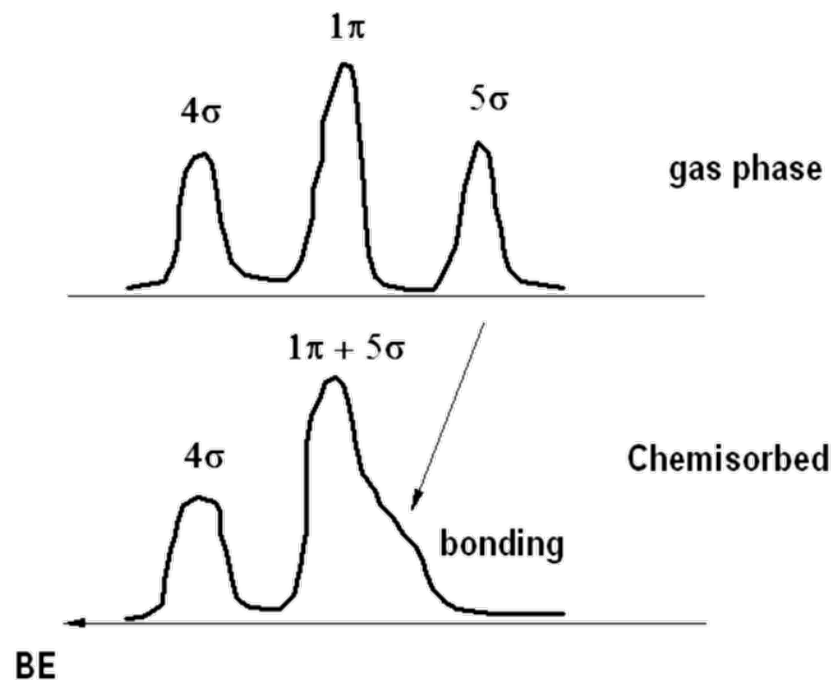

UPS spectra of CO on clean Ni (the 5σ orbital take part in the bonding to the surface) versus clean Ni.

CO adsorbed on clean Ni

Bare Ni

