



Biocatalysis

Udo Kragl

Universität Rostock, Institut für Chemie,
Lehrstuhl für Technische Chemie
Albert-Einstein-Str. 3A, 18059 Rostock, Germany
Tel. +49-381-498-6450, Fax +49-381-498-6452
Email udo.kragl@uni-rostock.de
www.chemie.uni-rostock.de/kragl



University of Rostock - f



Ge

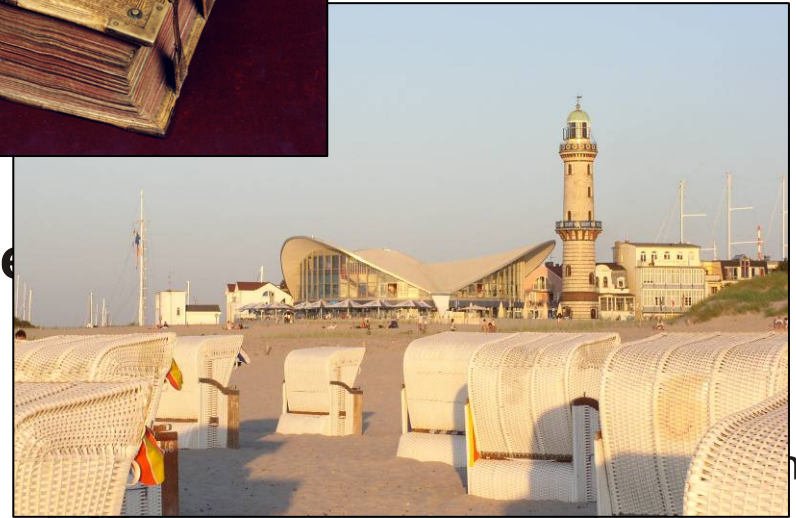

Bonn



Technical Chemistry - Research Topics

- **Rostock University, Department of Chemistry**



- Biocatalysis, ionic liquids
- Downstream processing of low molecular weight compounds
- Renewable resources
- Trace analysis
- Optimisation of reaction conditions, modelling

- **Leibniz Institute for Catalysis**



- Multi phase catalysis
- Polymerisation of propene oxide
- Functionalisation of renewable resources...
- ...

in total 22 coworker

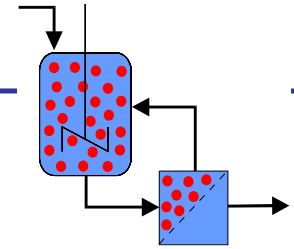

- **Biocatalysis**
 - (enantio)-selective oxidation, C-C-bonding
 - biocatalysis in ionic liquids
- **Downstream processing of low molecular weight compounds**
 - membrane processes for desalting, concentration
 - combination of extraction, chromatography, scCO₂ extraction, membrane processes (product orientated)
- **Use of renewable resources („Biogene Rohstoffe“)**
 - fermentation (rare sugars, biomaterials)
 - plant compounds
 - chemo- and biocatalytic functionalisation
- **Trace analysis (environment, processes)**
 - Equipment: GC, LC, GC-MS, LC-MS, ion chromatography
- **Optimisation of reaction conditions**
 - model based or „black box“ (genetic algorithm)

Outline

- **introduction**
- **examples**
 - **industry**
 - **academia**
- **take home message**



**‘Enzymes are proteins,
things of beauty and joy forever’
<R. N. Perham, 1976>**

Opinions & Prejudices - hopefully overcome

Biocatalysts

- are sensible and not stable

➔ operational stability for several months has been achieved

- work only in diluted aqueous solutions

➔ molar solutions, organic solvents possible

- give only low space-time yields

➔ several kg/(L×d) possible

Facts

Biotransformations are used for synthesis of bulk and fine chemicals, such as:

high-fructose corn sirup	Glc-Fru isomerase	> 8x10 ⁶ t/a
acrylamide	nitrile hydratase (wc)	> 30,000 t/a
7-aminocephalosporinic acid	acylase	> 200 t/a
chiral amines	lipase	> 100 t/a
chiral alcohols	oxidoreductase (wc)	1 t/a (?)

... today more than 100 biotransformations are applied in industry...

Productivities of Biotechnological Processes

Process/Product	Productivity (g l ⁻¹ hr ⁻¹)	Price (\$ kg ⁻¹)
Fermentations		
Citric acid	7.0	1.5
L-Lactic acid	4.0	2.5
Glutamic acid	3.0	2.0
Ethanol	1.5	0.70
Lysine	0.6	13
Penicillin G	0.17	20
Vitamin B ₁₂	0.001	8000
Enzymatic		
Glucose → fructose	200	2.0
Fumaric acid → aspartic acid	20	3.0
Cinnamic acid → phenylalanine	15	10
Chemical		
Acetic acid (MeOH + CO)	500	0.75
Ethanol from ethylene	80	0.70
DL-Methionine	15	3.0

Recent Books on Biocatalysis & Biotransformations

 WILEY-VCH

A. Liese, K. Seelbach, C. Wandrey

Industrial Biotransformations

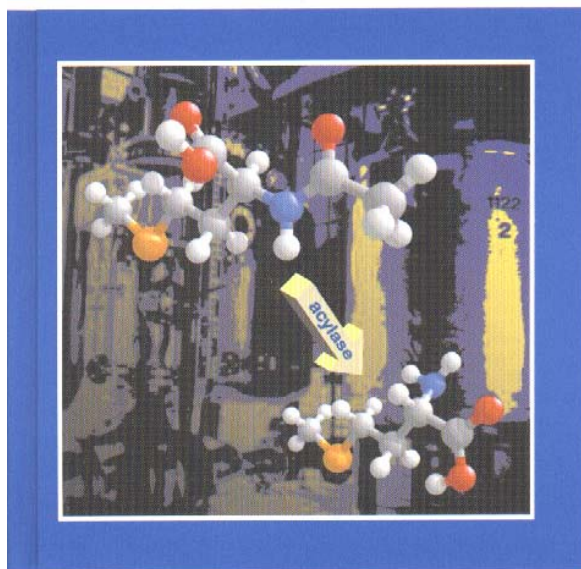

Stereoselective Biocatalysis

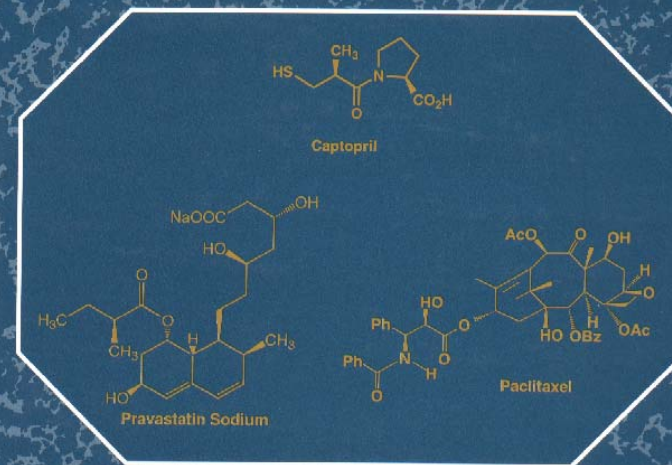

edited by
Ramesh N. Patel

Biocatalysis – Established with a Great Future

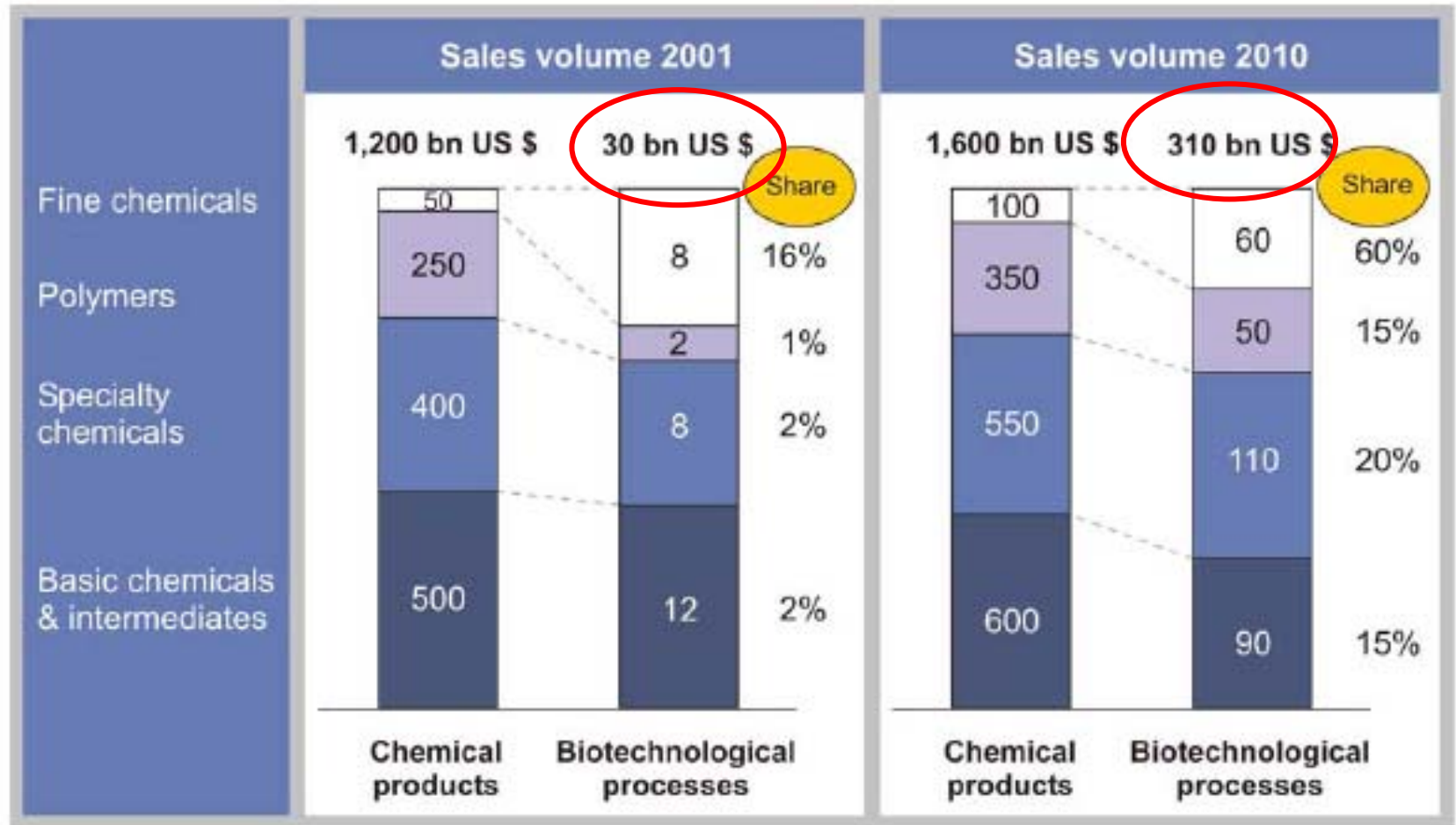

Growth of sales volume for Biotechnology until 2010

Biotechnology

- **biotransformation**

- whole cell
- enzyme



- **fermentation**

- de novo synthesis from nutrients



Process Development – an Integrated View

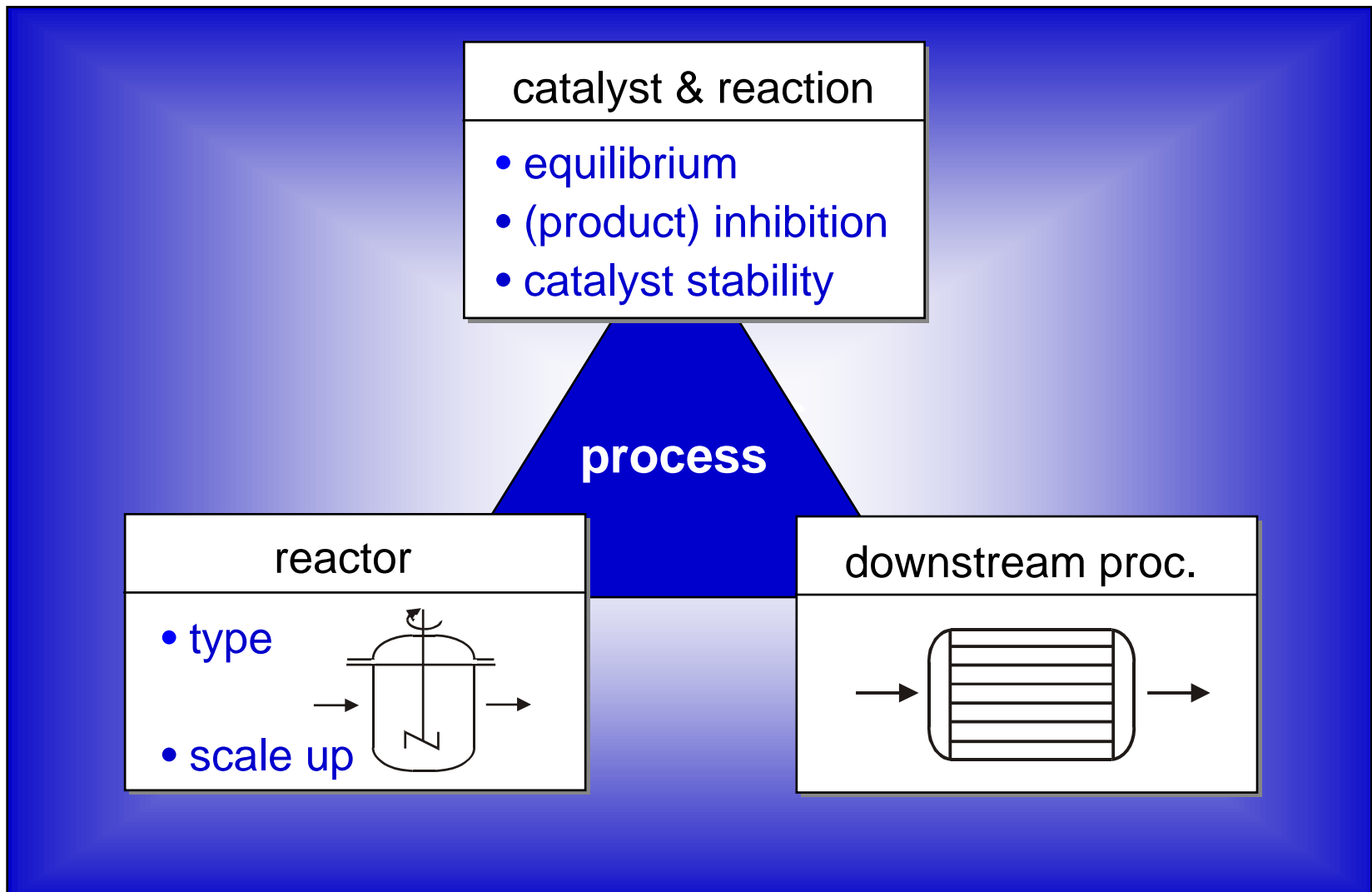

BRENDA
The Comprehensive Enzyme Information System

EC-Number Enzyme Name Organism Advanced Search

Search Display entries

use * as a wildcard (e.g. *kinase)

New: **Sequence Search** and **Short tutorial**
 Free access for **University of Rostock**

Nomenclature	Reaction & Specificity	Functional Parameters
Enzyme Names EC Number Common/ Recommended Name Systematic Name Synonyms CAS Registry Number	Catalysed Reaction Reaction Type Natural Substrates Substrates and Products Substrates Products Inhibitors Cofactors Metals/Ions Activating Compounds Ligands	Km Value Ki Value Turnover Number Specific Activity pH Optimum pH Range Temperature Optimum Temperature Range
Isolation & Preparation		Organism-related information
Purification Cloned Renatured Crystallization		Organism Source Tissue Localization
Stability	Enzyme Structure	Disease & References
pH Stability	Sequence/ SwissProt link	Disease

Suppliers of Enzymes

- Fluka, Sigma, Merck...
-
- Novo Nordisk
 - Amano
 - Toyobo
 - Unitika
 - Biocatalysts
 - Codexis
www.codexis.com
 - University groups working in Biochemistry,
Mikrobiologie

Enzyme Kinetics

- pH, temperature
- activity: 1 U = 1 $\mu\text{mol}/\text{min}$; 1 kat = 1 mol/s
- Michaelis-Menten type saturation kinetics
- for >1 substrates order of binding to the enzyme has to be considered
 - ordered
 - random
 - ping-pong
- substrate-surplus & product inhibition may occur
- references:
 - Cornish-Bowden
 - Segel
 - Biselli, Kragl, Wandrey in Drauz, Waldmann (eds)

Recovery of Enzymes or Cells

- immobilisation on a heterogeneous support by
 - adsorption
 - covalent attachment (eg. Eupergit)
- cross-linking
- entrapment in hydrogels (alginate...)

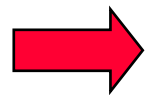

covalent attachment often increases thermal stability, but method has to be developed individually, immobilisation yield <100% (activity!)

- ultrafiltration (enzymes)
- microfiltration, centrifugation

Classification of Enzymes

Ligases

bond formation under energy consumption

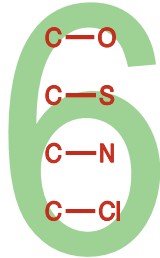

Oxidoreductases

reduction and oxidation

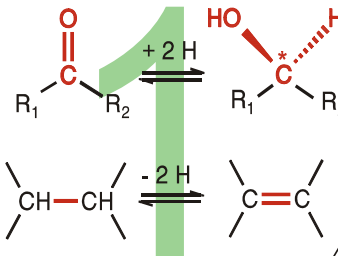

Transferases

transfer of complete groups

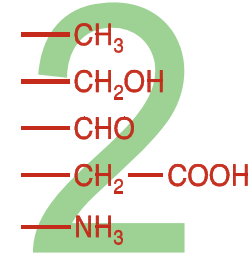

Isomerases

isomerisation and racemication

glucose \rightleftharpoons fructose

D-alanine \rightleftharpoons L-alanine

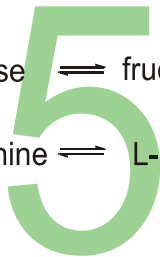

Lyases

bond formation/cleavage

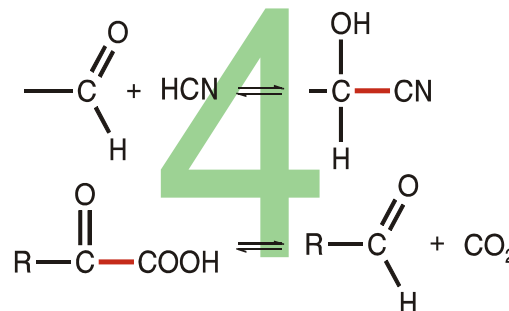

Hydrolases

cleavage under H₂O consumption

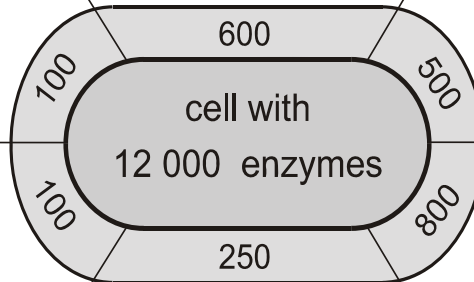
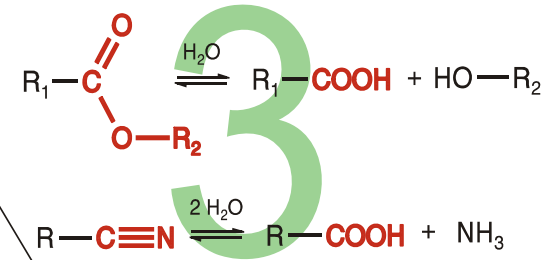

Enzyme Classification & Enzyme Source

- enzymes with the same EC-number and CAS-number but from different origin may react totally different!
- lipase EC 3.1.1.3
 - *Burkholderia plantarii* (BASF-prozess)
 - *Pseudomonas cepacia*
 - *Mucor miehei*
 - *Pseudomonas fluorescens*
 - *Candida antarctica*
 - *Serratia marescens*

Zygosaccharomyces rouxii

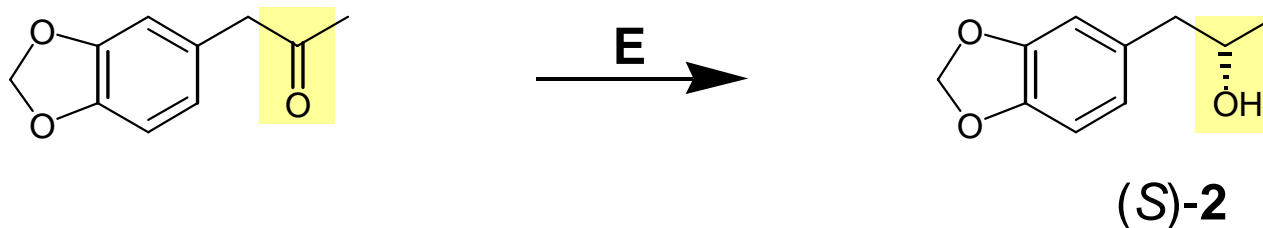

1 = 3,4-methylenedioxyacetophenone
2 = 4-(3,4-methylenedioxyphenyl)-2-propanol

Eli Lilly

reaction conditions:

[1]: < 0.011 M, 2 g L⁻¹
pH: 7.0
T: 33 - 35 °C

process parameters:

yield: 96 %
ee: > 99.9 %
reactor type: batch
reactor volume: 300 L
capacity: kg scale
space-time-yield: 75 g L⁻¹d⁻¹

Integration in Chemical Synthesis

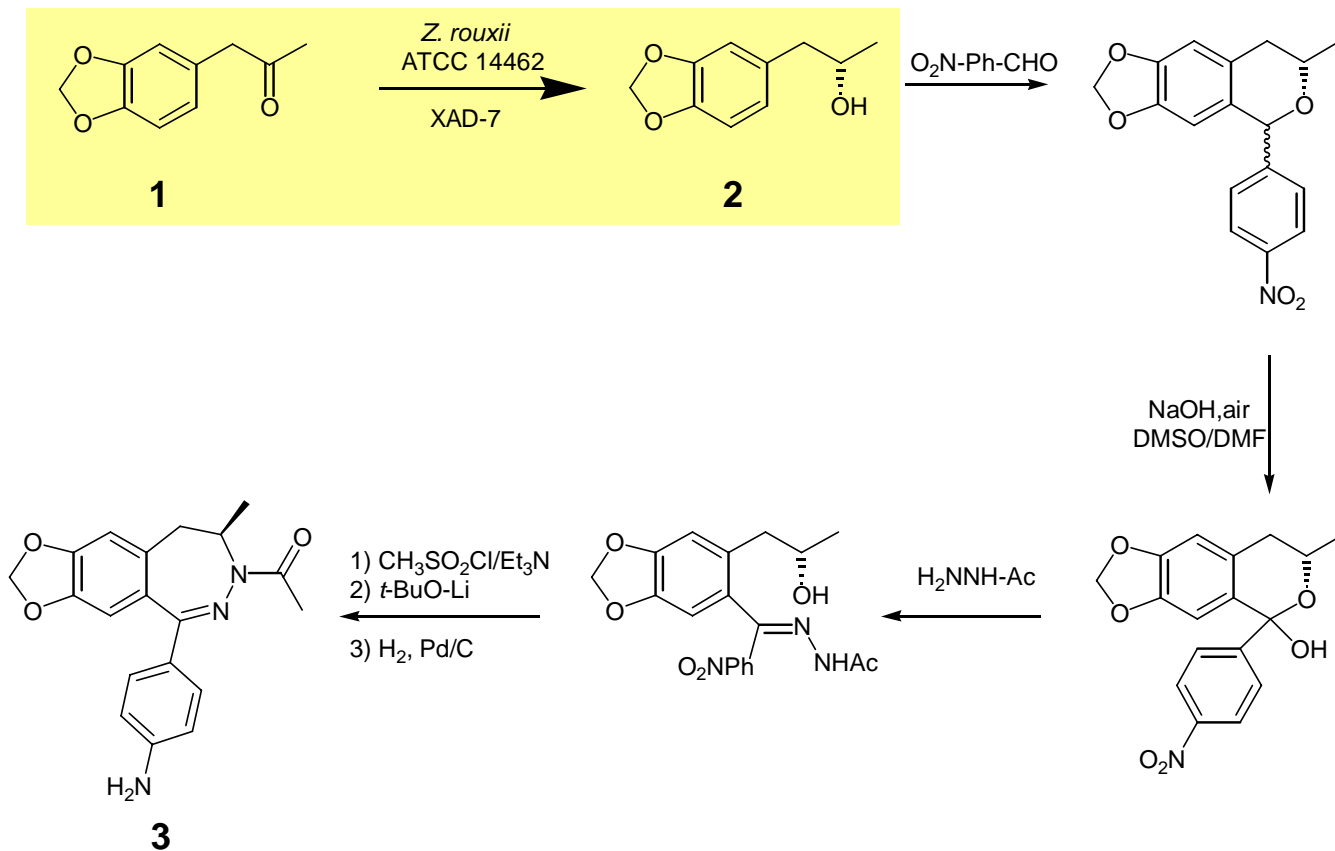

1 = 3,4-methylenedioxyacetophenone
2 = (S)-4-(3,4-methylene-dioxophenyl)-2-propanol
3 = LY300164

The product is tested for treatment of amyotrophic lateral sclerosis.

Ketone Reduction using Whole Cells

- whole cells of *Zygosaccharomyces rouxii*
- substrate and product are **toxic** for the cells
 ➔ XAD-resin as substrate reservoir and for product extraction

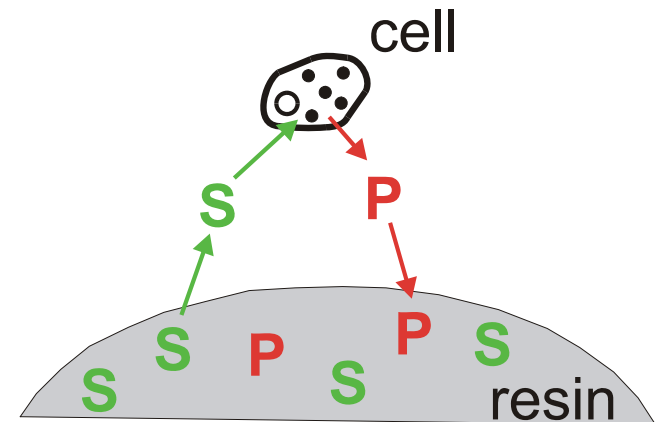
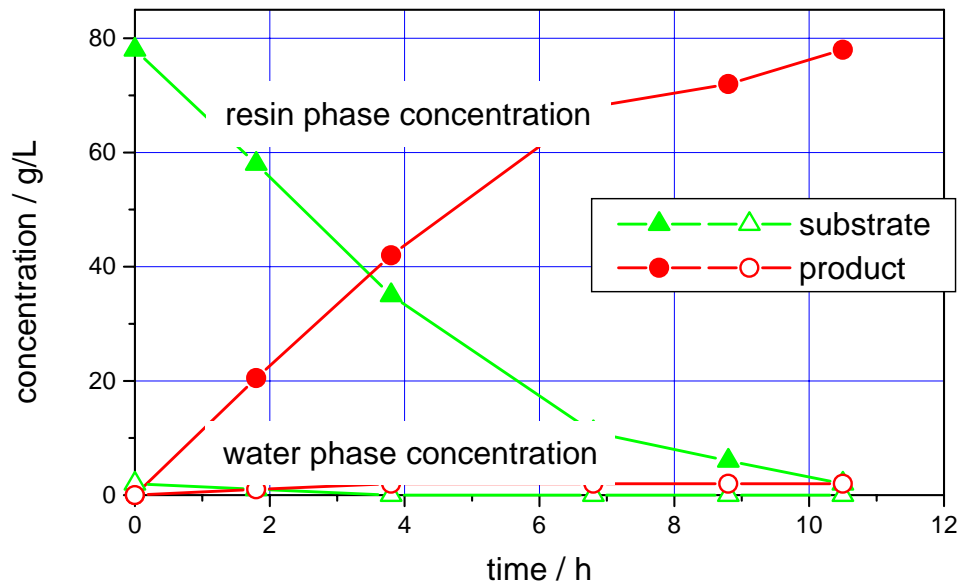

Flow Scheme

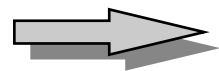
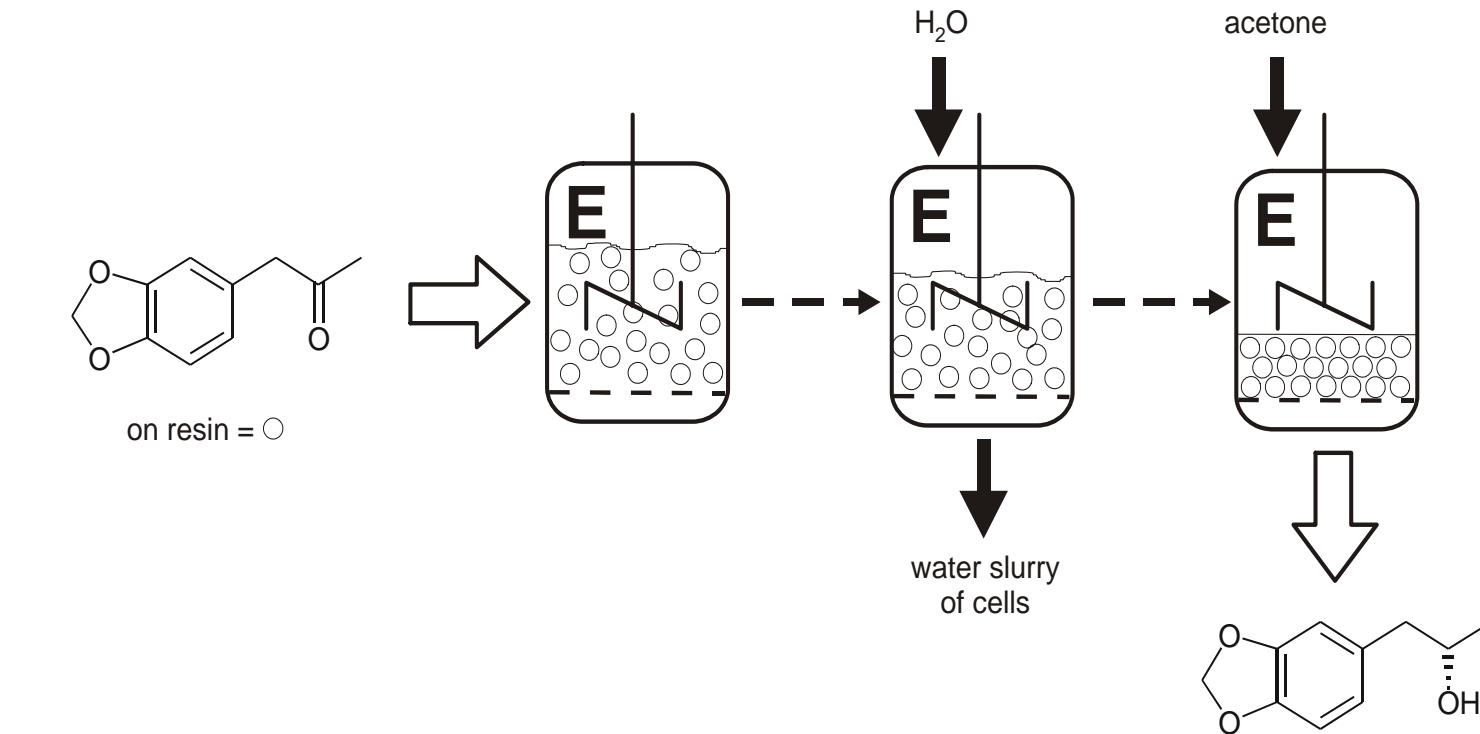

- **XAD-7 resin is retained by 150 µm filter**
- **yeast cells are in filtrate**
- **product is liberated by washing resin with acetone**

Neurospora crassa

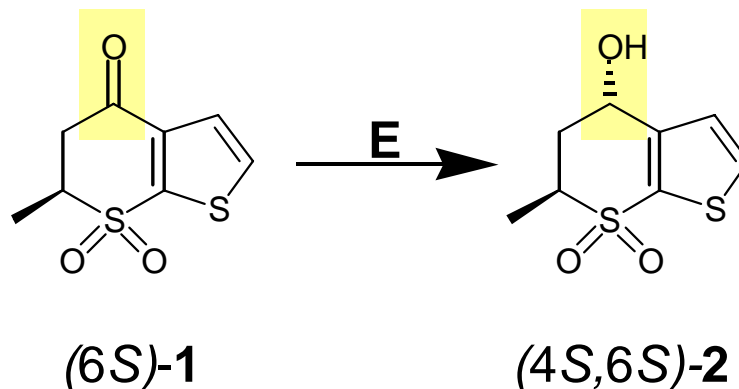

1 = 5,6-dihydro-6-methyl-4H-thieno[2,3b]thiopyran-4-one-7,7-dioxide

2 = 5,6-dihydro-4-hydroxy-6-methyl-4H-thieno[2,3b]thiopyran-7,7-dioxide

Zeneca Life Science Molecules

reaction conditions:

pH: 3.8-4.3
T: 33 °C
medium: aqueous
catalyst: suspended whole cells

process parameters:

yield: > 85
ee: > 98 %
reactor type: batch
capacity: multi t
start-up date: 1994

Substitution of Chemical Steps

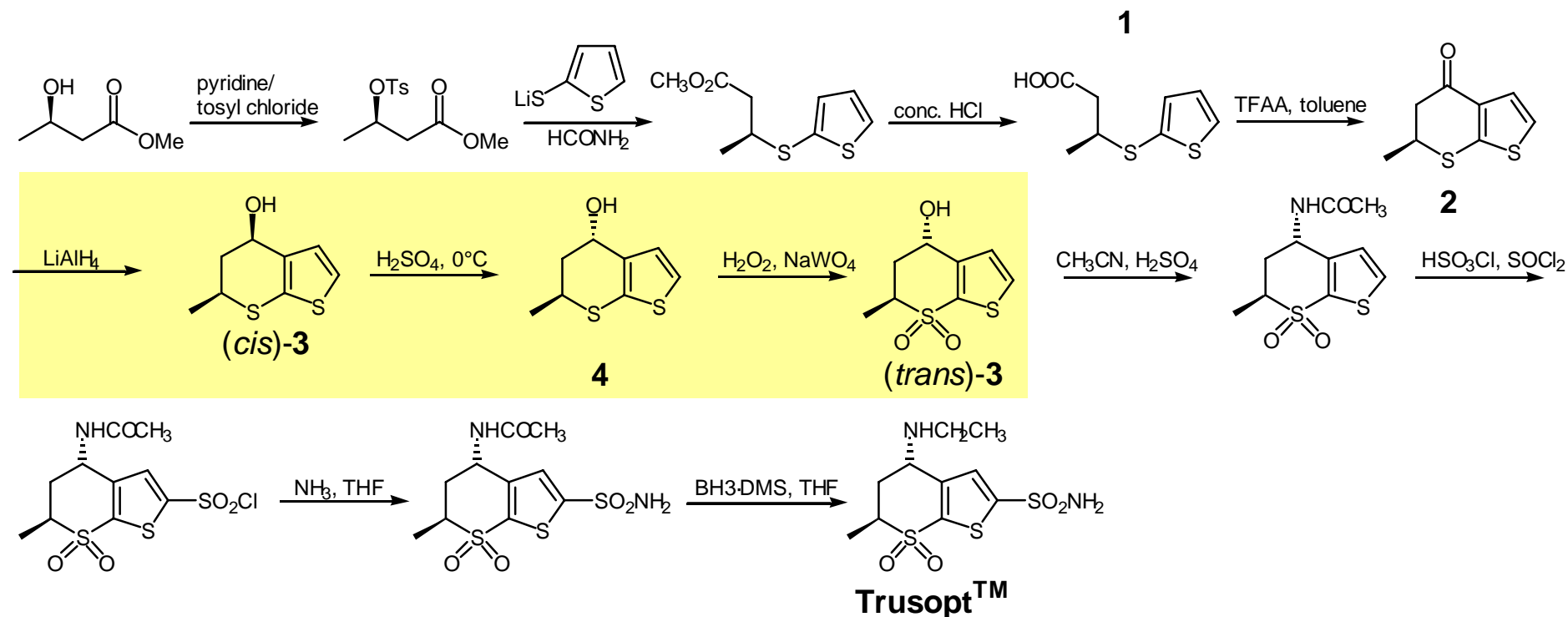

- Trusopt™ (Merck) is a novel, topically active treatment for glaucoma
- inversion of *cis* alcohol is **incomplete in chemical synthesis**

Why Biotransformation at pH 3.8 - 4.3 ?

➡ to prevent epimerization that takes place above pH 5!

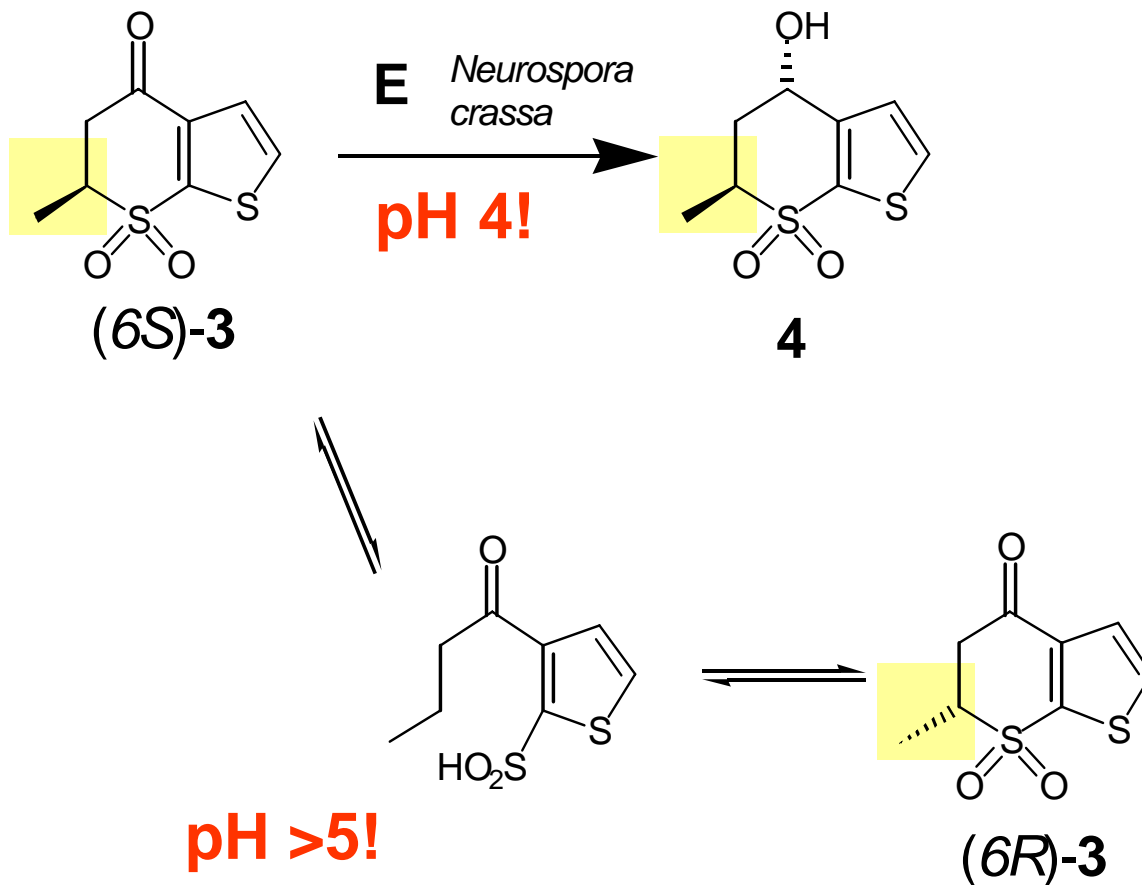

Enzymatic Oxidation Reactions

- oxidation with enzymes of EC class 1:
 - **oxidoreductases**
 - oxygenation with O_2 or H_2O_2
(→ dehydrogenation)

- oxidation with enzymes of EC class 4:
 - **lyases**
 - addition of water

Achromobacter xylosoxidans

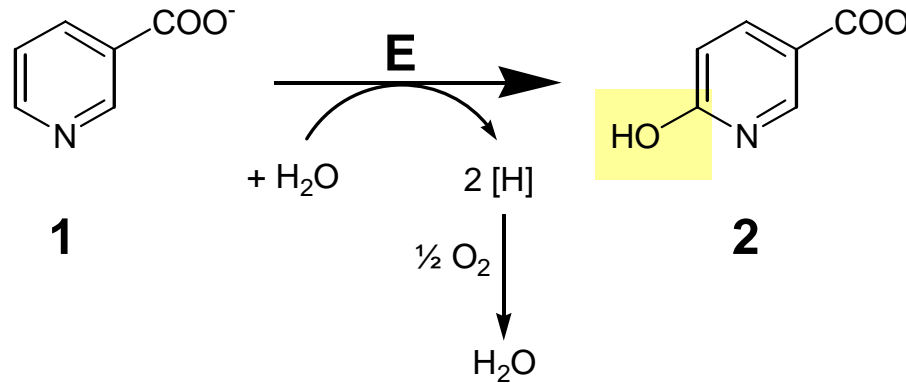

1 = niacin = nicotinic acid = pyridine-3-carboxylate

2 = 6-hydroxynicotinate = 6-hydroxy-pyridine-3-carboxylate

Lonza AG

reaction conditions:

[1]: 0.533 M, 65 g L⁻¹
pH: 7.0
T: 30 °C
catalyst: suspended whole cells

process parameters:

conversion: >90 %
yield: > 90 % (overall)
reactor type: batch
reactor volume: 12 000 L
capacity: several tons
residence time: 12 h

Flow Scheme

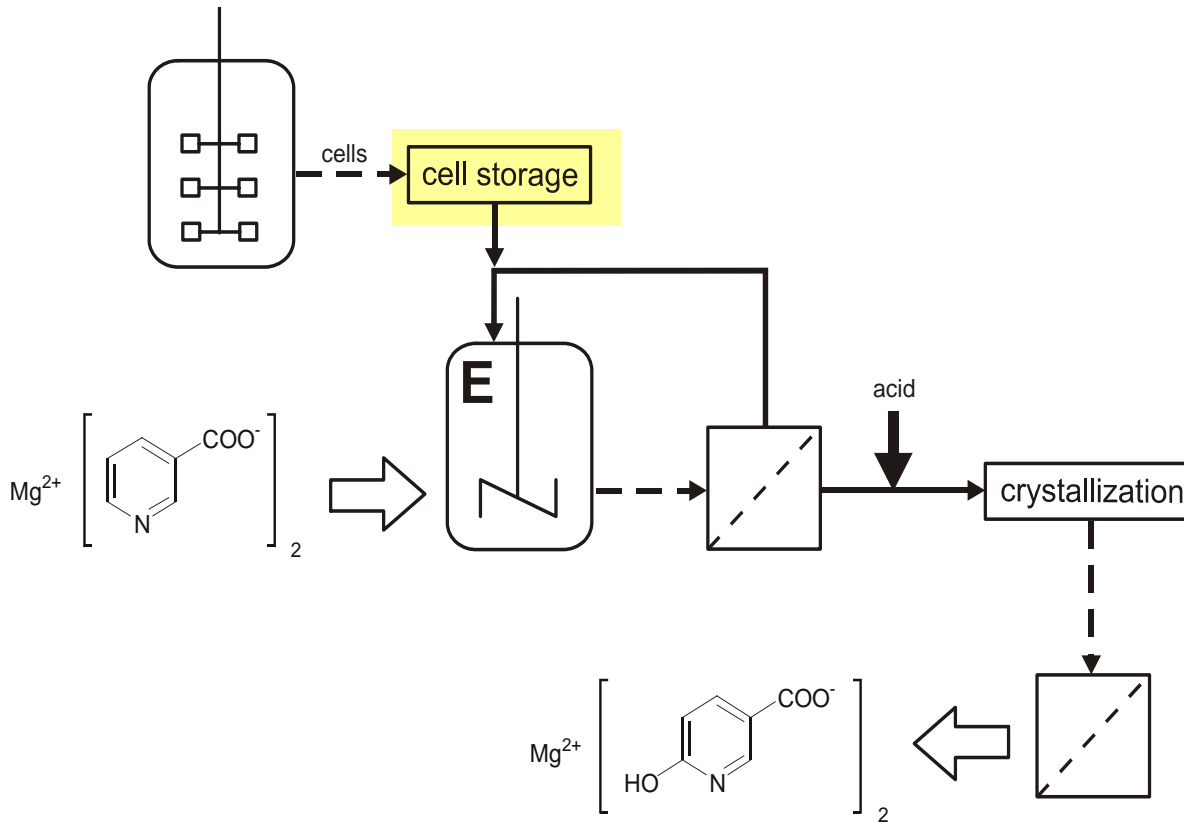

In contrast to the biotransformation the **chemical synthesis** of 6-substituted nicotinic acids is **difficult and expensive** due to the separation of by-products.

D-Amino Acid Oxidase

EC 1.4.3.3

Trigonopsis variabilis

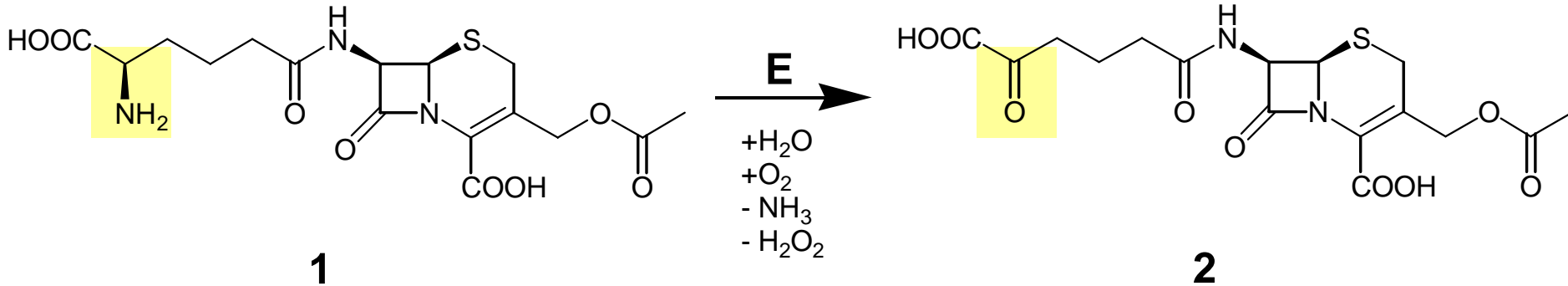

1 = Cephalosporin C

2 = α -ketoadipinyl-7-aminocephalosporanic acid

Hoechst Marion Roussel

reaction conditions:

process parameters:

[1]: 0.02 M, 7.47 g L⁻¹
pH: 7.3
T: 25 °C
catalyst: **immob. enzyme**

reactor type: **batch**
reactor volume: 10 000 L
capacity: 200 t·a⁻¹
residence time: 1.5 h
dsp: direct transfer to 7-ACA production
enzyme consumption: 1.1 U·g⁻¹

D-Amino Acid Oxidase

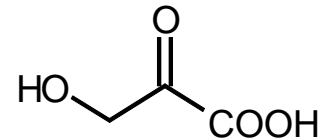
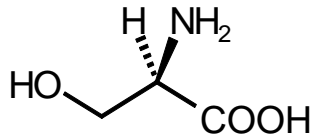
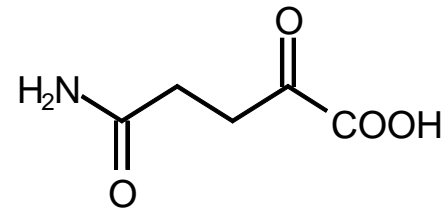
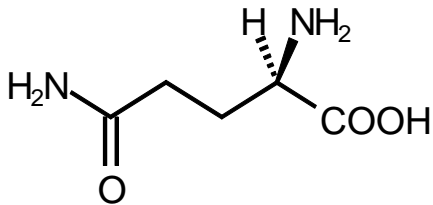
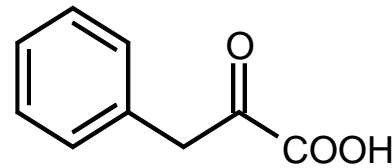
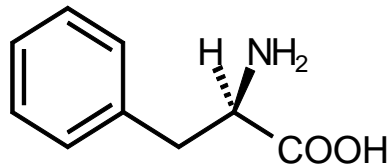
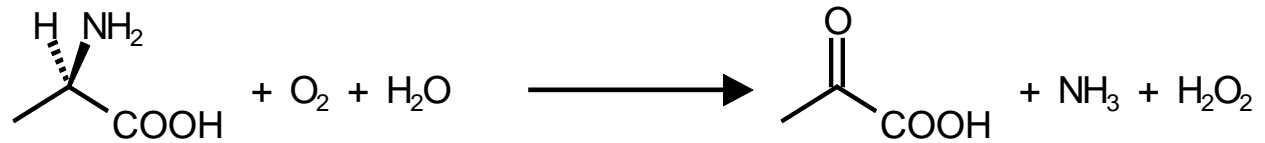

E.C. 1.4.3.3, *Trigonopsis variabilis*, 25 U/mg

Substitution of Chemical Synthesis

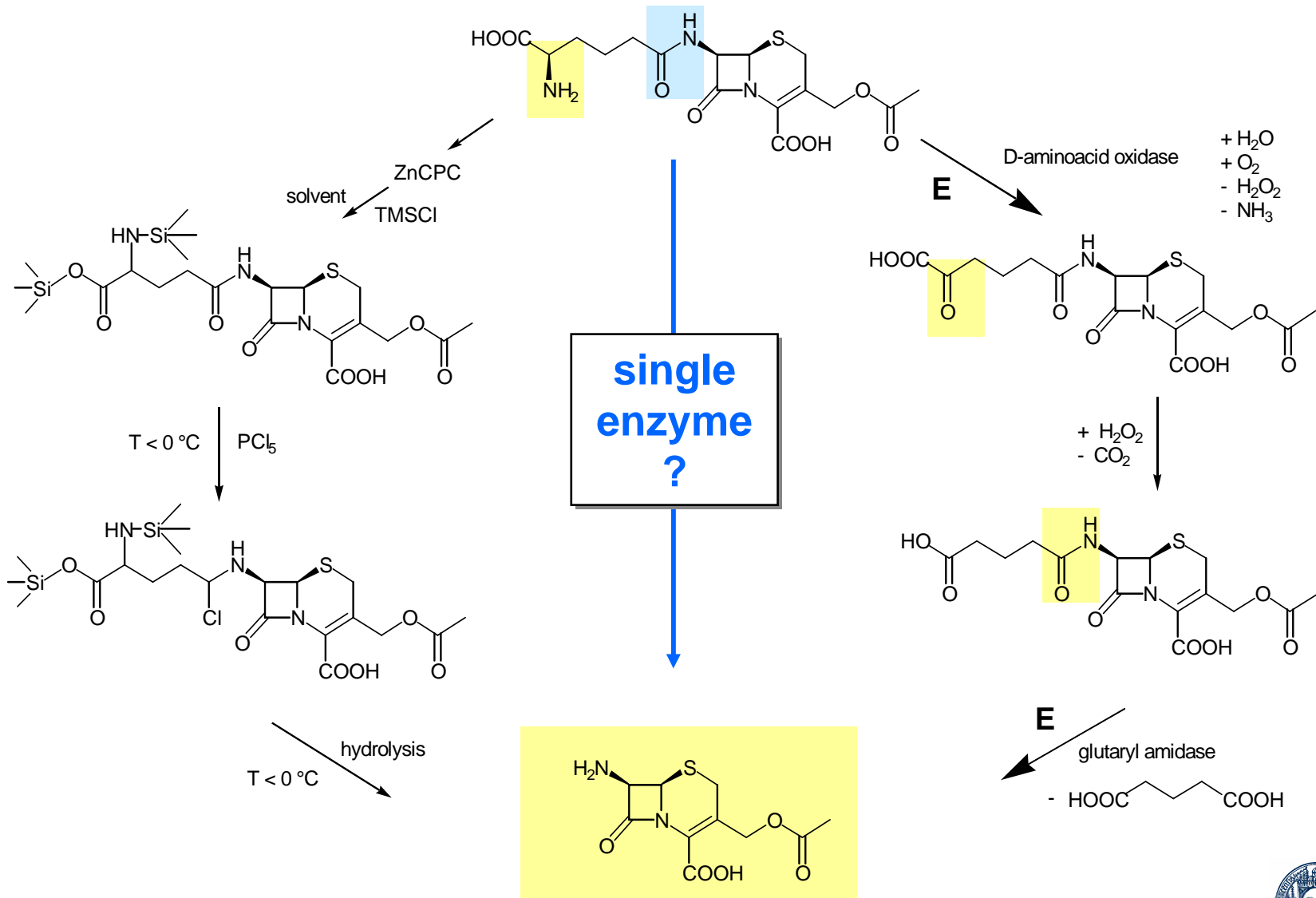

Synthesis of 7-ACS - Comparision of Processes

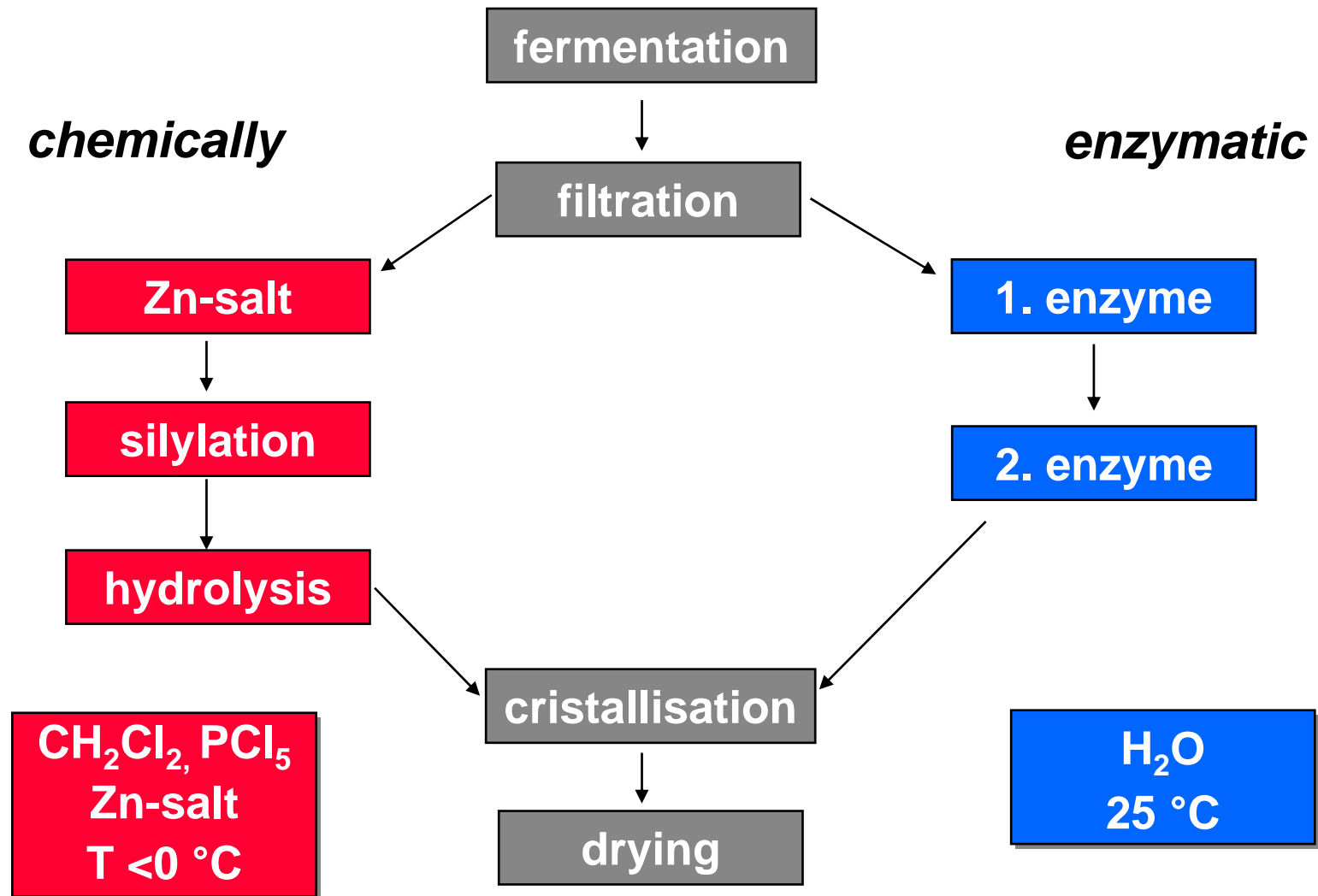

Advantages of the Enzymatic Process

- **no toxic compounds**
- waste water can be easily degraded biologically
- no dangerous chemicals
- reduction of the amount of **waste**:
 - **0.3 t** compared to **31 t** (for 1 t 7-ACA)



reduction of the cost contribution for waste treatment and disposal from 21% to 1% of the overall process costs

Oxygen Activation: FAD

- alkene oxidation, coordinated to Pd (Wacker-process → acetaldehyde

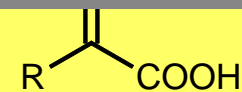
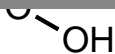
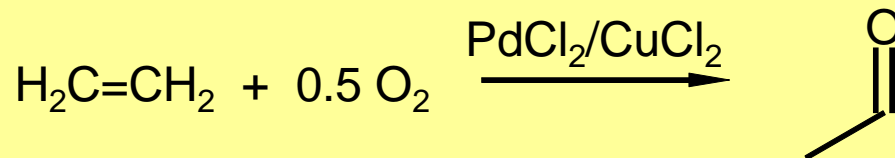
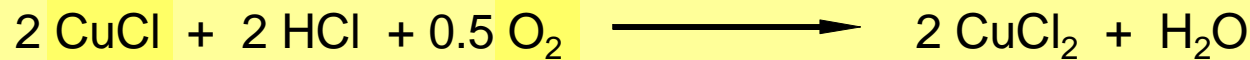
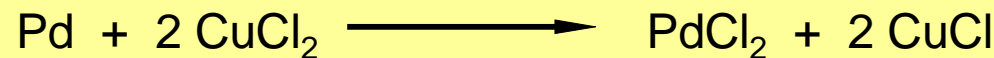
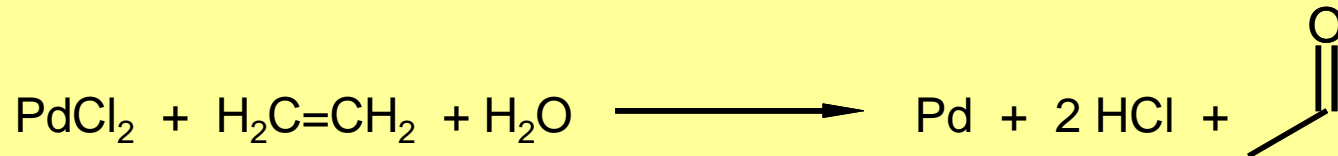

Oxygen Activation: FAD

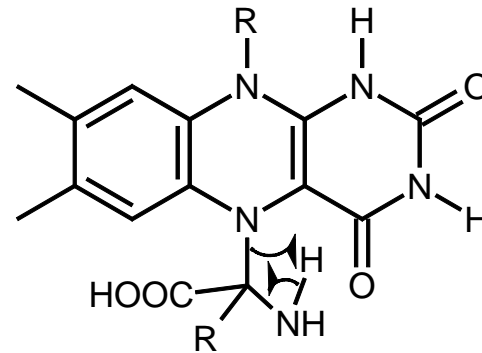
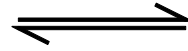
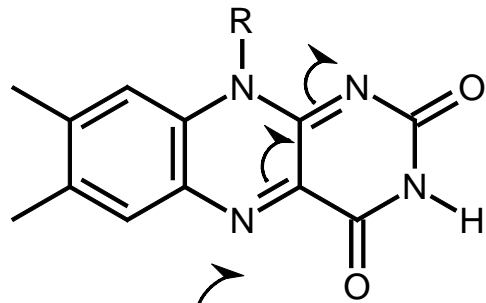

R = H
 → Riboflavin
 R = adenine dinucleotide
 → FAD

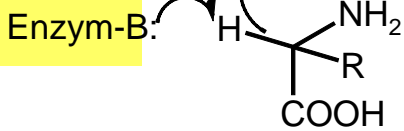

- H₂O₂

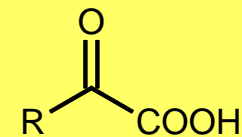
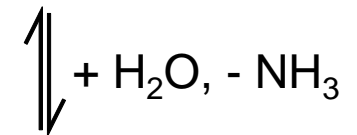
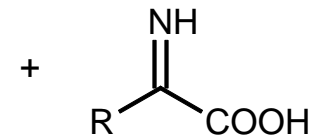
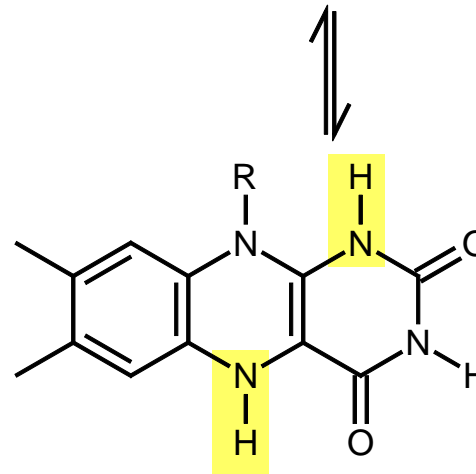
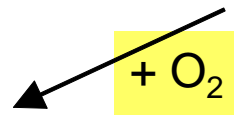
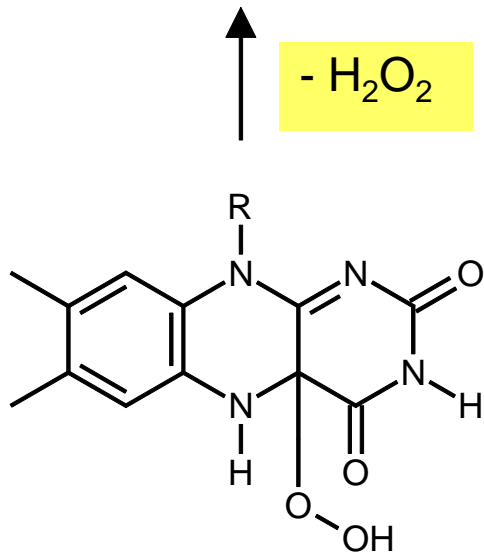

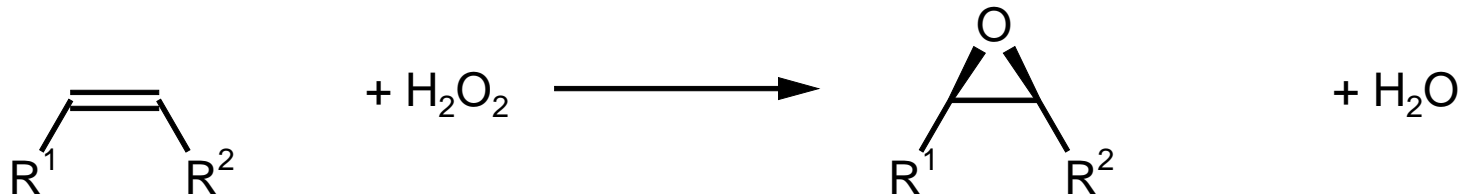
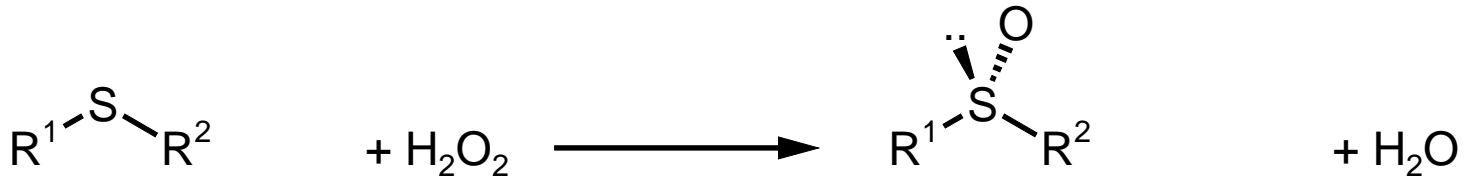
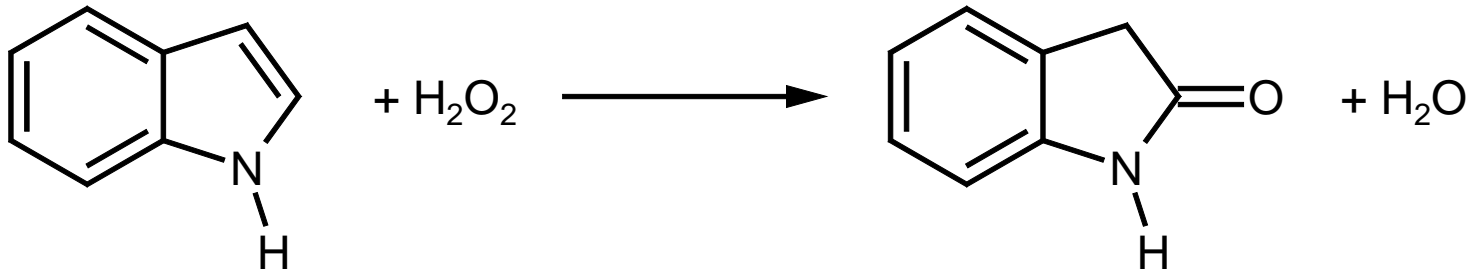

Oxygen Activation: Chemo- ↔ Biocatalyst

- oxygen transfer

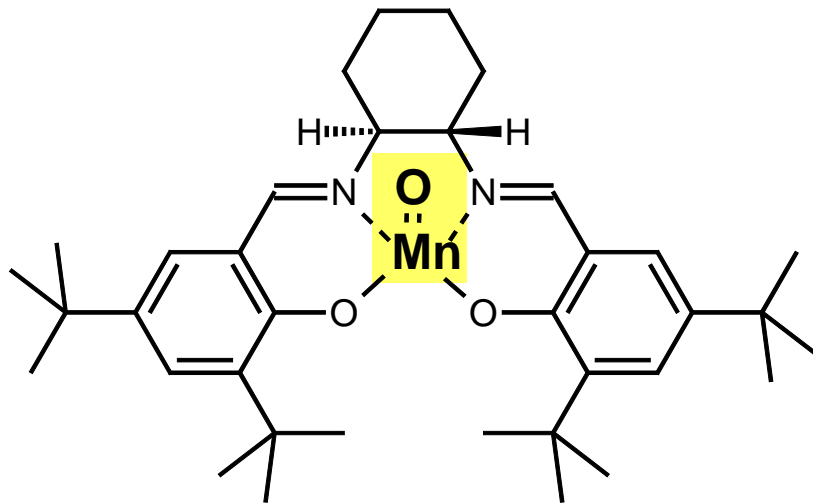
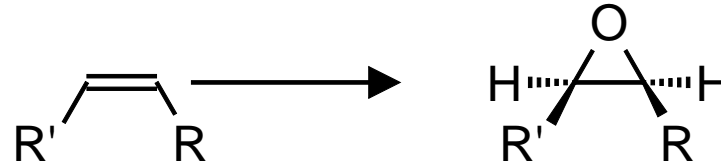

Mn-salen complex
NaOCl
0.75 min⁻¹

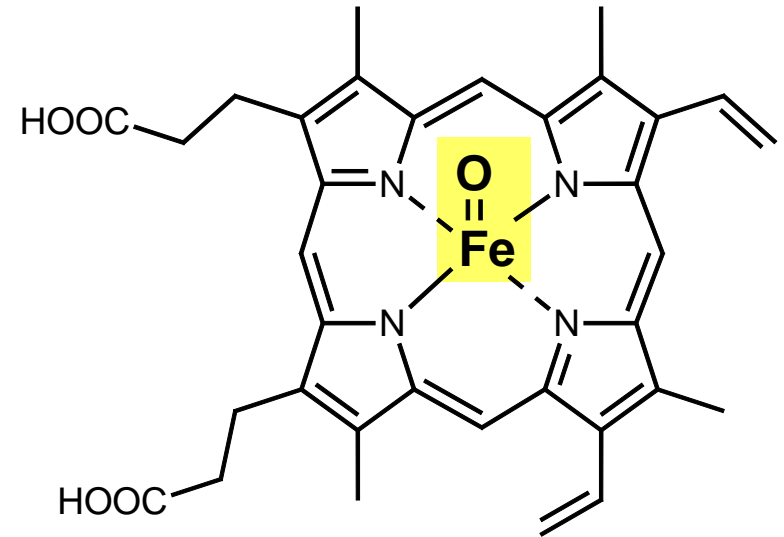

peroxidase (hem)
H₂O₂
75 min⁻¹

Pseudomonas putida

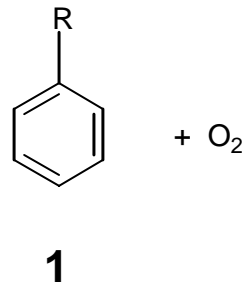

+ O₂

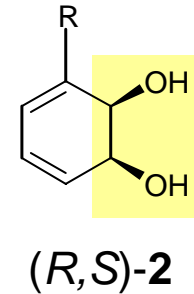
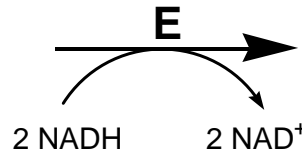

R = H, F, Me, CF₃

1 = benzene

2 = 1,2-dihydroxycatechol

ICI

reaction conditions:

process parameters:

catalyst: suspended whole cells

selectivity: > 99.5 %

capacity: several t a⁻¹

Degradation of aromatics by microbial di-oxygenases

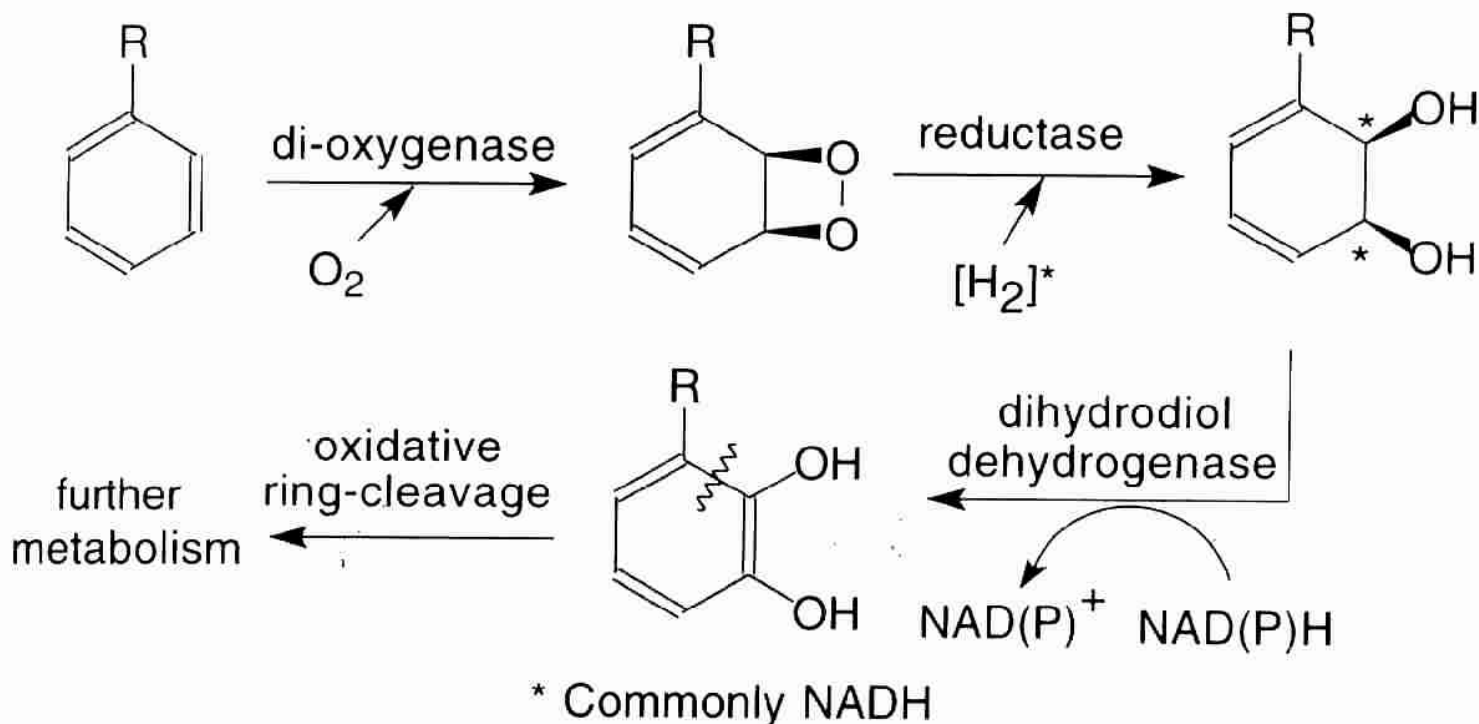

- 1968: mutant strain from *P. putida* was lacking the activity of the dihydrodiol dehydrogenase.
- *Pseudomonas putida* exhibits a high tolerance to the aromatic substrates that are normally toxic to microorganisms.

Product Range of Benzoate Dioxygenase

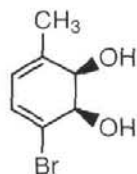

P. putida
(ref. 25,39)

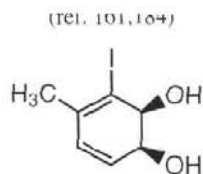

P. putida UV4
E. coli JM109(pDTG601A)
(ref. 170)

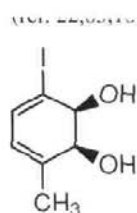

P. putida UV4
E. coli JM109(pDTG601A)
(ref. 169, 170)

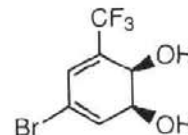

P. putida 39/D
E. coli JM109(pDTG601A)
(ref. 219)

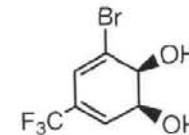

P. putida 39/D
E. coli JM109(pDTG601A)
(ref. 219)

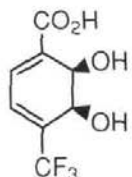

P. putida JT107
(ref. 177)

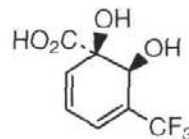

P. putida mt-2 +
A. eutrophus B9
(ref. 183)

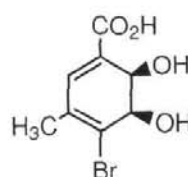

P. putida JT107
(ref.40)

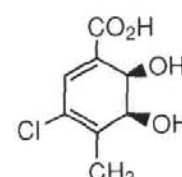

P. putida JT107
(ref. 40)

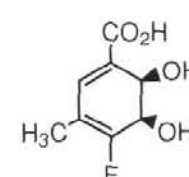

P. putida JT107
(ref. 40)

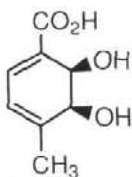

P. putida JT107
(ref. 40)

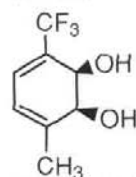

P. putida UV4
(ref. 169)

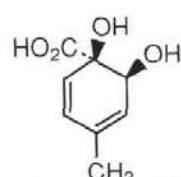

A. eutrophus B9
(ref. 38,175)

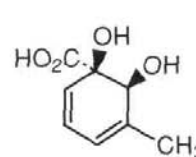

A. eutrophus B9
Pseudomonas sp. B13
(ref. 38,39,175)

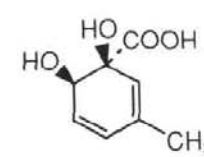

Pseudomonas sp. B13
(ref. 39,175)

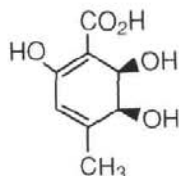

P. putida JT107
(ref. 40)

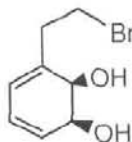

P. putida 39/D
E. coli JM109(pDTG601A)
(ref. 192)

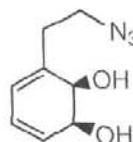

E. coli JM109(pDTG601A) X = CN, SCN, NCS, OAc, OH
(ref. 242)

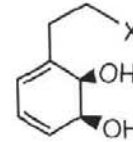

E. coli JM109(pDTG601A)
(ref. 242)

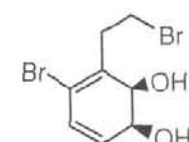

P. putida 39/D
E. coli JM109(pDTG601A)
(ref. 193)

Pseudomonas putida

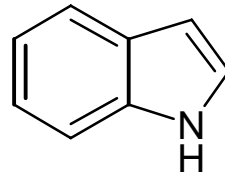

1

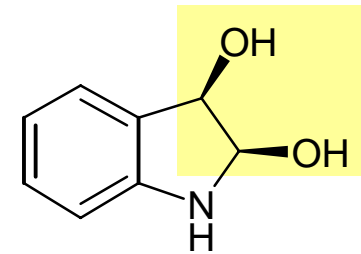
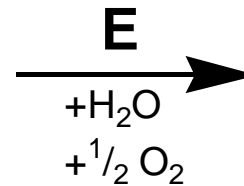

2

1 = 1H-indole

2 = 2,3-dihydro-1H-indole-2,3-diol

Genencor

reaction conditions:

process parameters:

catalyst:

whole cell

reactor type:

batch

Classical Route to Indigo

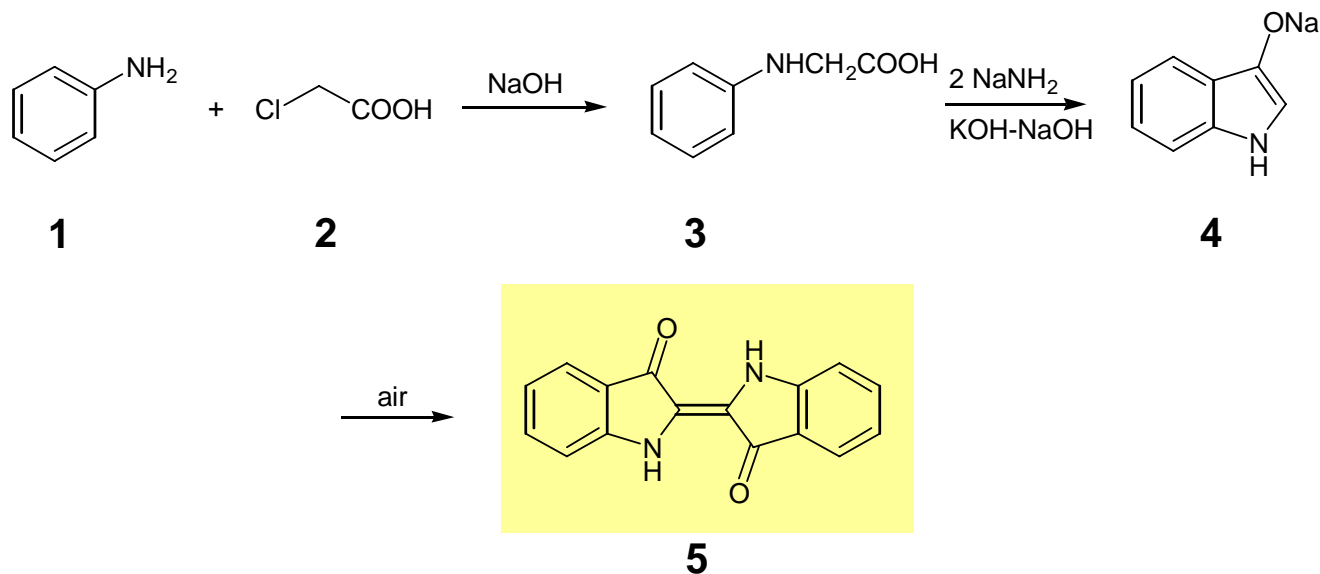

- 1 = phenylamine
2 = chloro-acetic acid
3 = phenylamino-acetic acid
4 = sodium salt of 1*H*-indole-3-ol
5 = indigo

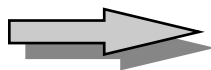

three steps are needed starting from aniline

New Catalytic Route (Mitsui Toatsu Chemicals)

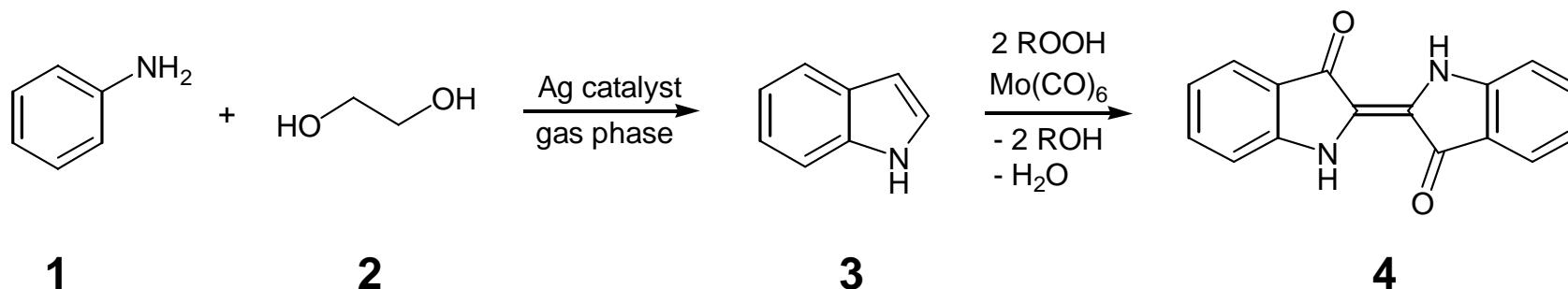

-
- 1 = phenylamine
 - 2 = ethane-1,2-diol
 - 3 = 1*H*-indole
 - 4 = indigo

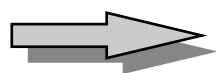

produces less organic salts than the classical route

Biosynthesis of Indigo

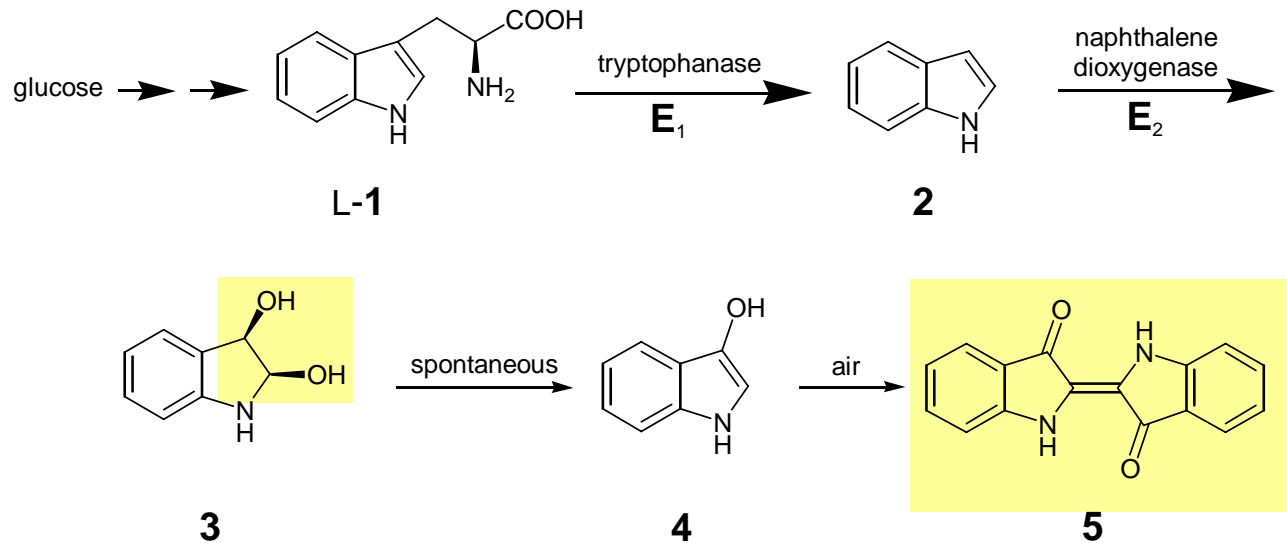

-
- 1 = L-tryptophan
 - 2 = 1*H*-indole
 - 3 = 2,3-dihydro-1*H*-indole-2,3-diol
 - 4 = 1*H*-indole-3-ol
 - 5 = indigo

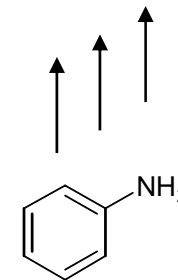

classical
chemical
route

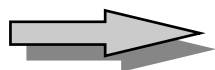

starts from cheap glucose with tryptophan as intermediate

Nocardia autotropica

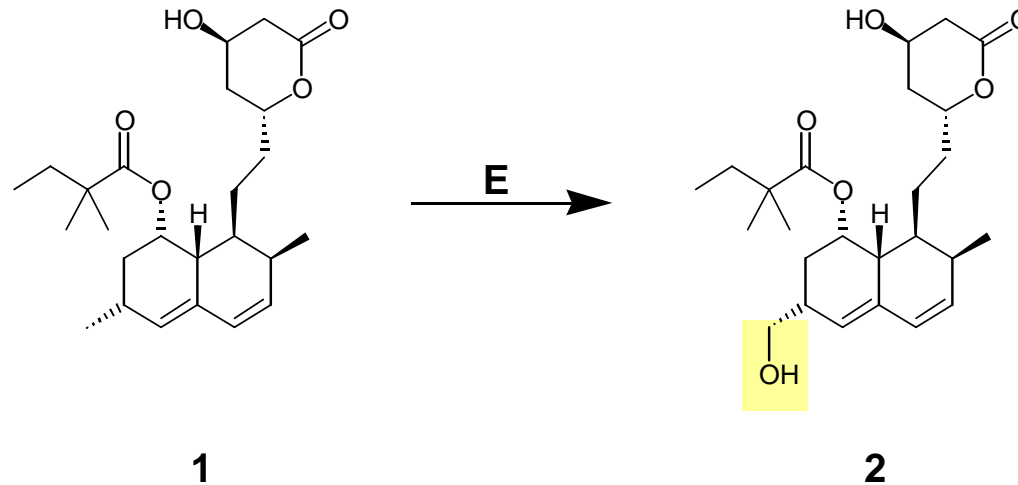

1 = Simvastatin
2 = 6-β-hydroxy-methyl-simvastatin (major product)

Merck Sharp & Dohme

reaction conditions:

process parameters:

[1]:	< 0.05 10 ⁻³ M, < 0.02 g L ⁻¹	yield:	24 %
[2]:	1.85 10 ⁻³ M, 0.8 g L ⁻¹	selectivity:	70 %
pH:	6.8	reactor type:	fed batch
T:	27 °C	reactor volume:	19,000 L
catalyst:	suspended whole cells		

Nocardia corallina

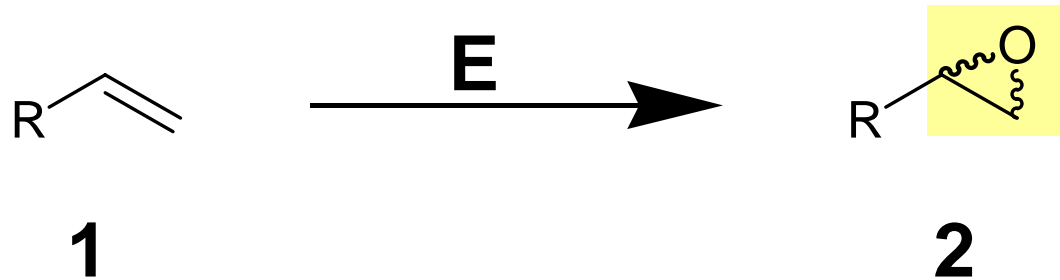

Nippon Mining

reaction conditions:

[1]:
two phase system
pH:
T: 30 °C
catalyst: suspended whole cells

process parameters:

yield: 92 %
selectivity: 94 %
reactor type: batch
rate of aeration is raised to strip
the short chain toxic epoxide

Substrate range

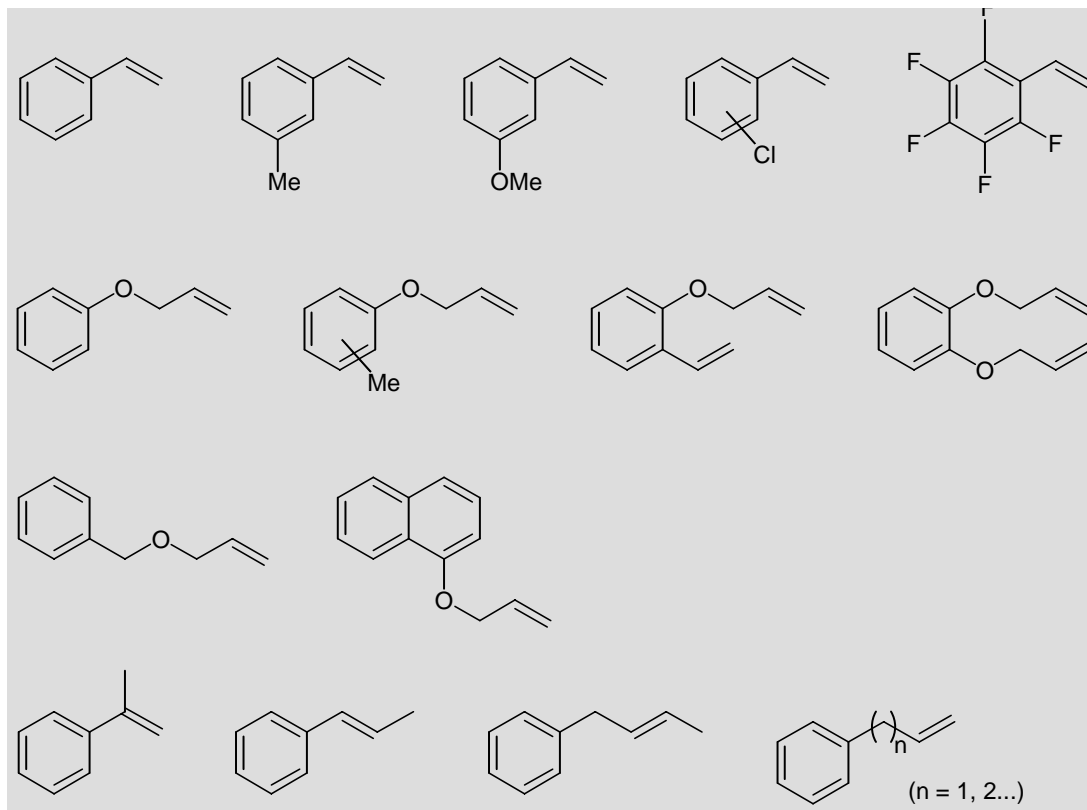
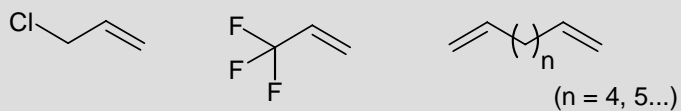
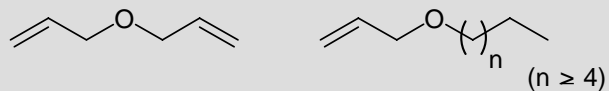
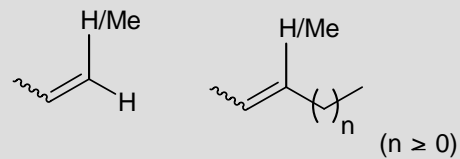
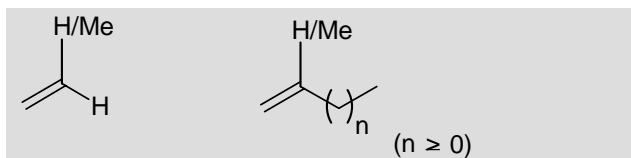

Microbial source

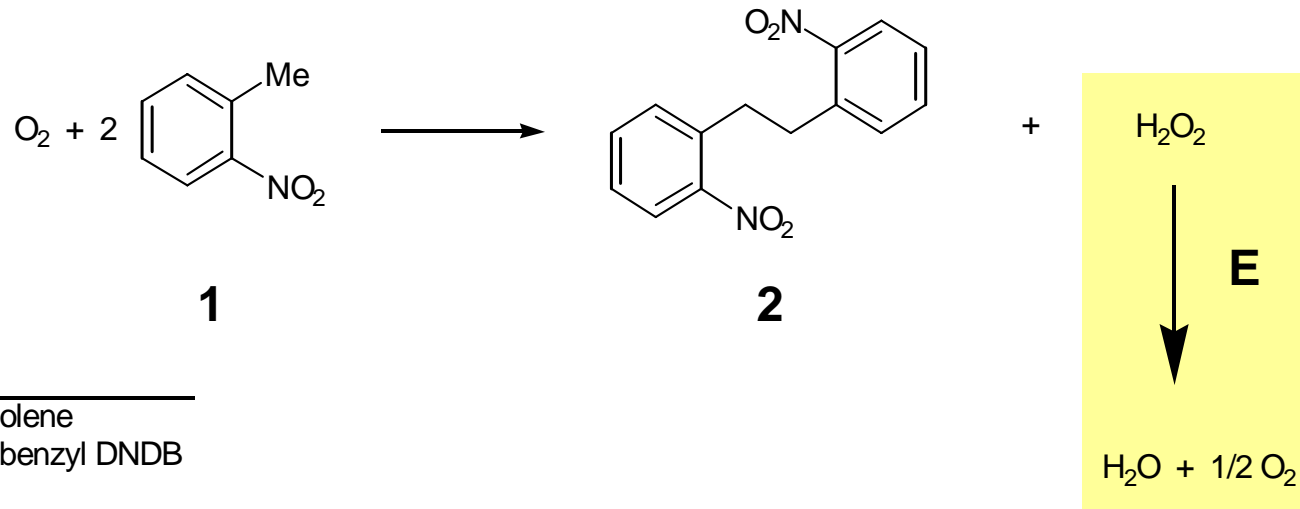

1 = nitrotoluene
2 = dinitrodibenzyl DNDB

Novartis

- **removal of side-product**
- only incomplete conversion with heavy-metal catalysts
- following process steps with DNDB are problematic by contamination with heavy-metal catalyst.

Flow Scheme

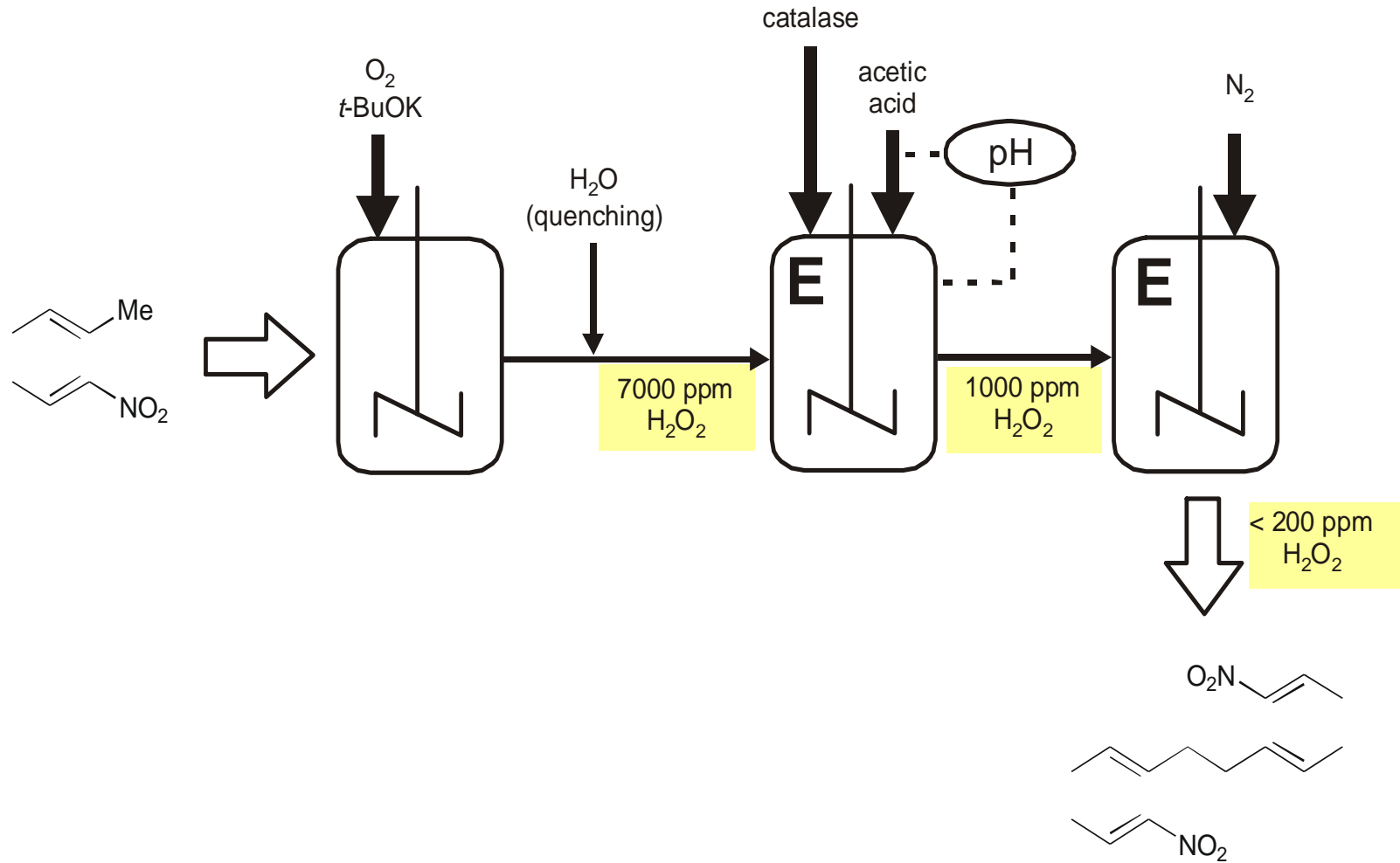

Bacillus circulans

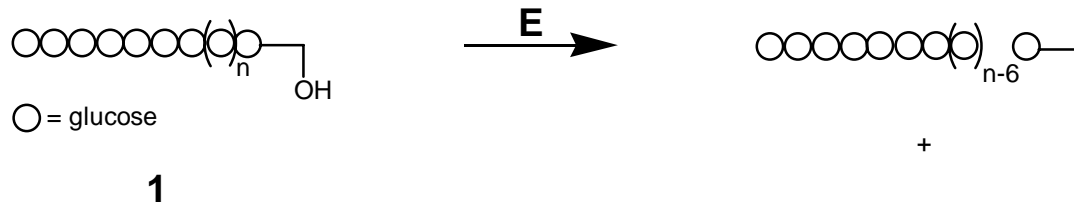

Problem:

adsorption of cyclodextrins for separation is ineffective at 55 °C

reaction conditions:

[1]: 8.3 w/v % liquified starch
pH: 5.8 – 6.0
T: **55 °C**
catalyst: soluble enzyme

process parameters:

yield: 22.3 % (α -cyclodextrin)
 10.8 % (β -cyclodextrin)
 5.1 % (γ -cyclodextrin)
chemical purity: 94.9 %
reactor type: batch

Flow Scheme - Integrated Process

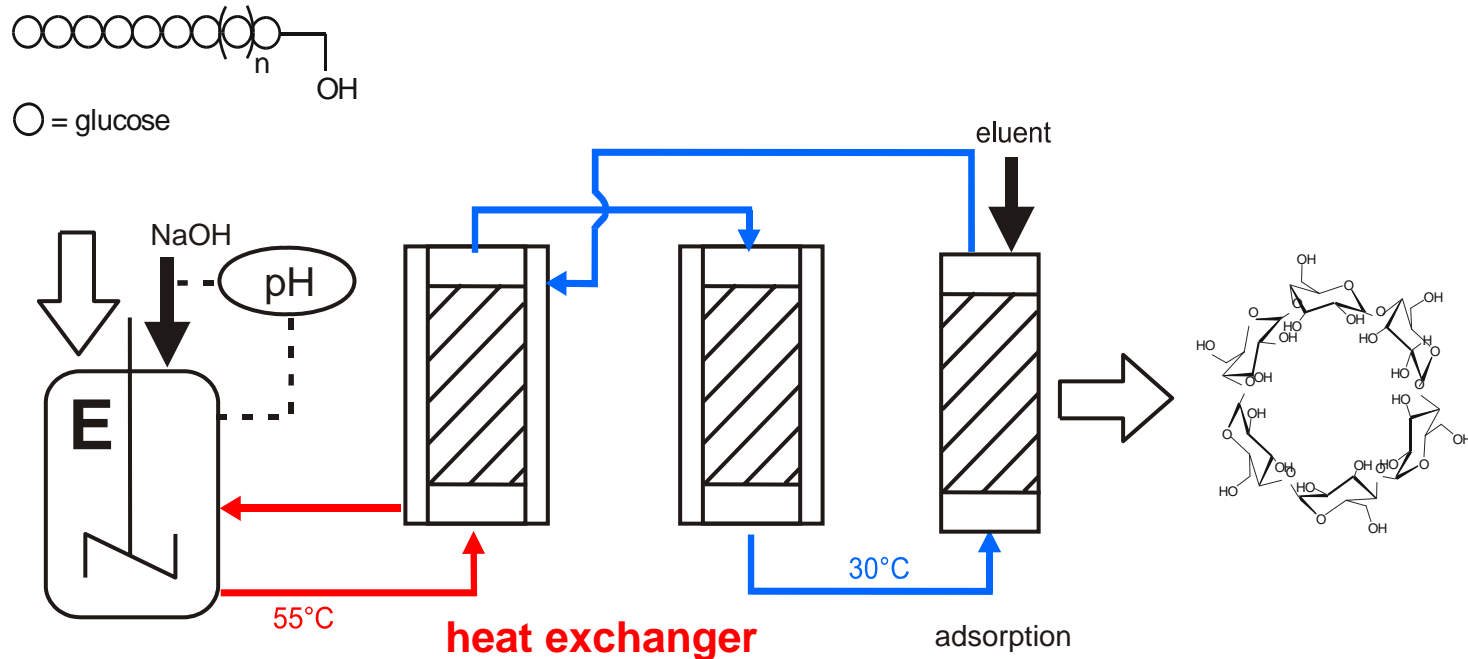

- **Temperature is lowered to 30 °C for effective adsorption.** (At this temperature almost no cyclodextrins are formed during circulation.)
- Before reentering the main reactor the temperature of the solution is again adjusted to 55 °C.
- To **prevent adsorption of the cyclodextrin glycosyltransferase** on the columns 3 w/v % NaCl are added.

Enzymatic Synthesis of GDP-Mannose

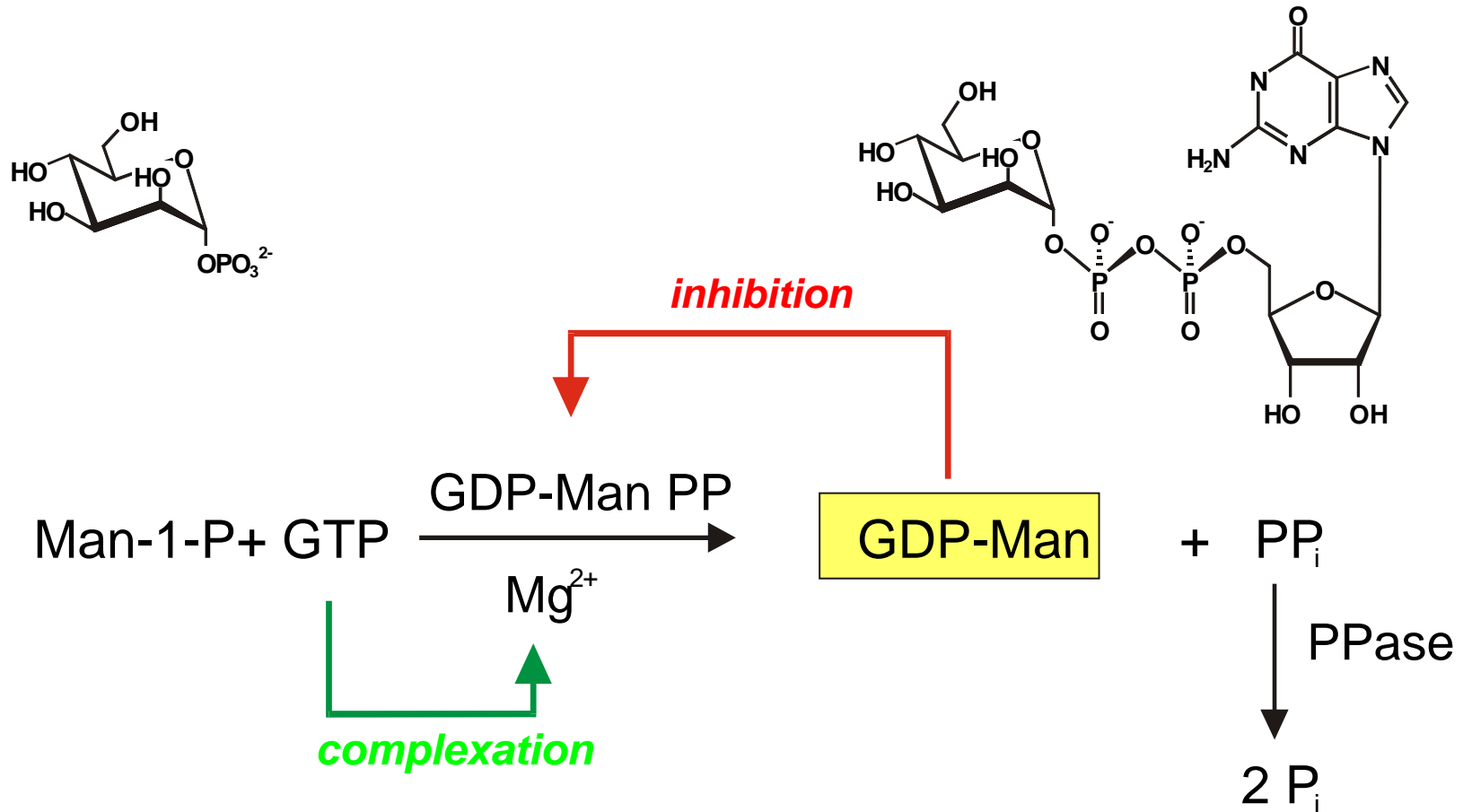

- GDP-Man-pyrophosphorylase
- inorganic pyrophosphatase

Modelling of Processes

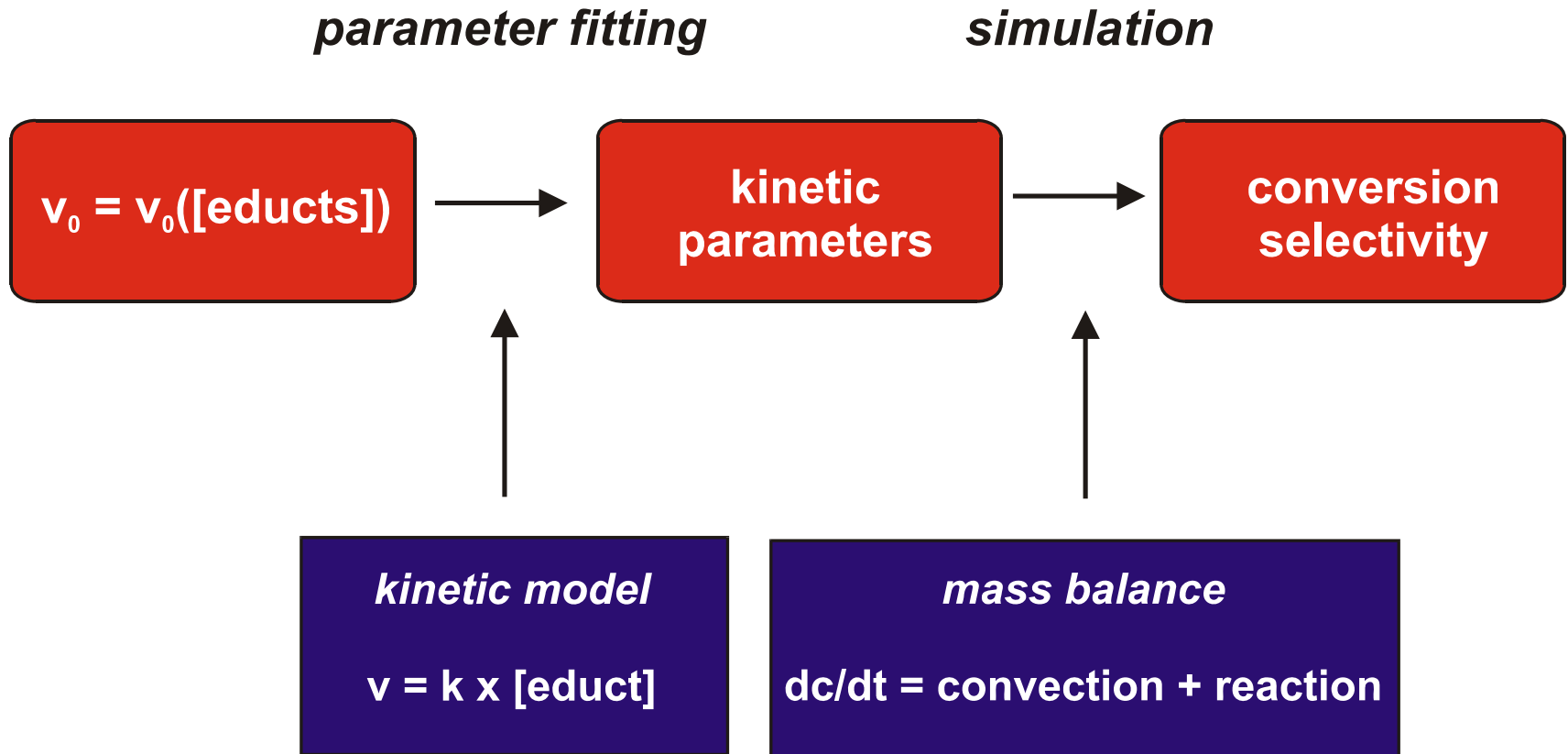

Kinetics of GDP-Man Pyrophosphorylase

$$v_1 = [E] \times A_{\max}^{\text{GMPP}} \times \frac{1}{1 + \frac{K_M^{\text{Mg}}}{\left(\frac{[Mg]}{[GTP]}\right)^2} + \frac{[Mg]}{K_i^{\text{Mg}} \times [GTP]}} \times \frac{[GTP]}{K_M^{\text{GTP}} \times \left(1 + \frac{[GDP-Man]}{K_i^{\text{GDP-Man}}} + \frac{[PP_i]}{K_i^{\text{PPi}}}\right) + [GTP]}$$

$$\times \frac{[\text{Man-1-P}]}{K_M^{\text{Man-1-P}} + [\text{Man-1-P}]}$$

A_{\max}^{GMPP}	15.0	U/mg	± 12.2	U/mg
K_M^{GTP}	40	μmol/L	± 9	μmol/L
$K_i^{\text{GDP-Man}}$	9	μmol/L	± 2	μmol/L
K_i^{PPi}	16	μmol/L	± 4	μmol/L
$K_M^{\text{Man-1-P}}$	15	μmol/L	± 3	μmol/L
K_M^{Mg}	2.9	-	± 2.6	-
K_i^{Mg}	0.1	-	± 0.09	-



Verification of Kinetic Model

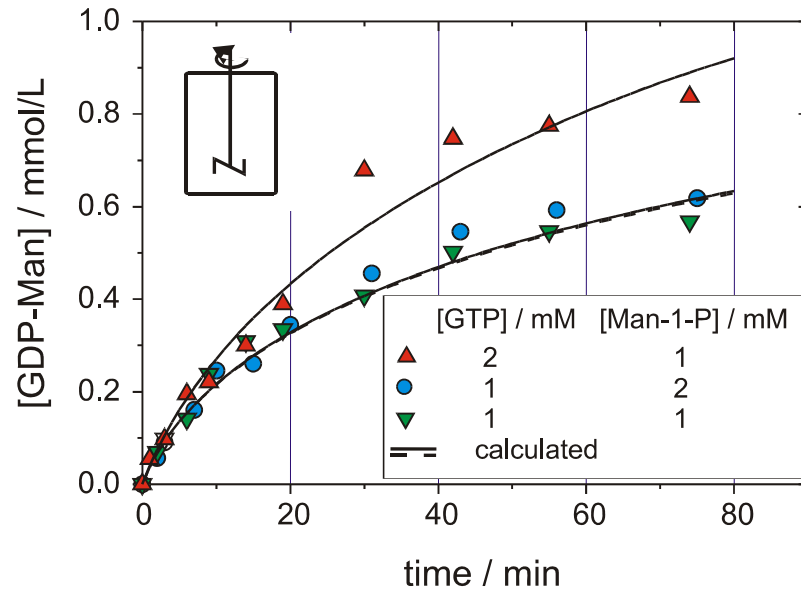

GDP-Man PP	0.044 U/mL
Pyrophosphatase	1.0 U/mL
MgCl ₂	5.0 mM

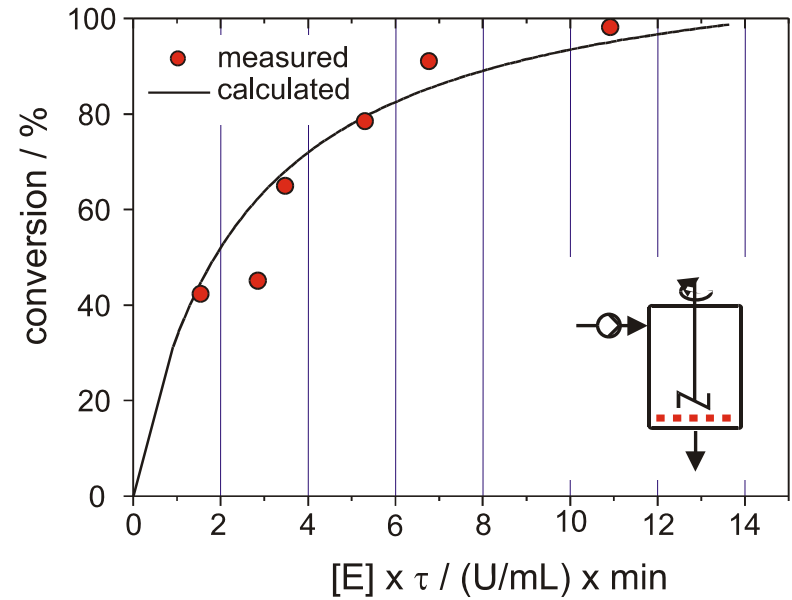

Man-1-P	2 mM
GTP	1 mM
25 °C, pH 8.0	



Concentration Profiles of Different Reactors

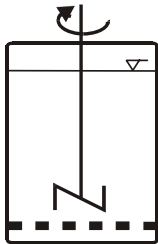
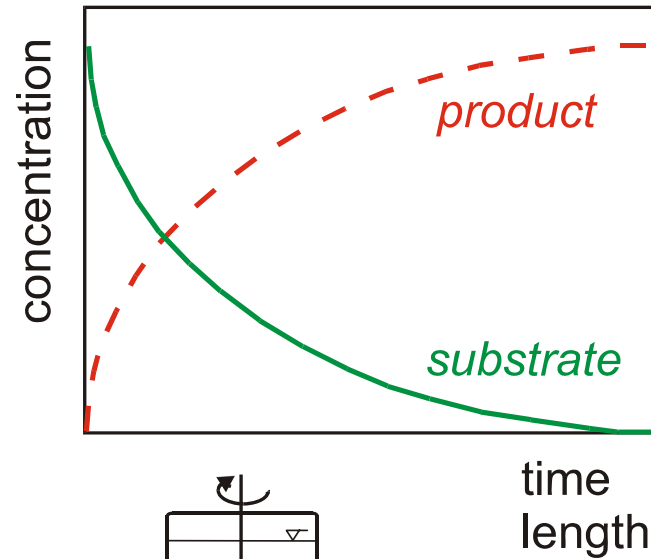

batch or plug flow

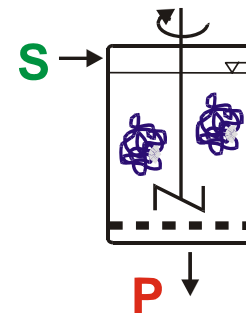
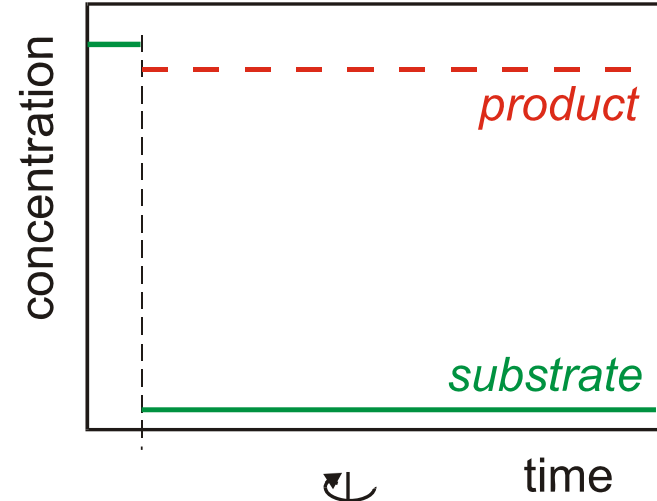

CSTR

Concentration Profiles of Different Reactors

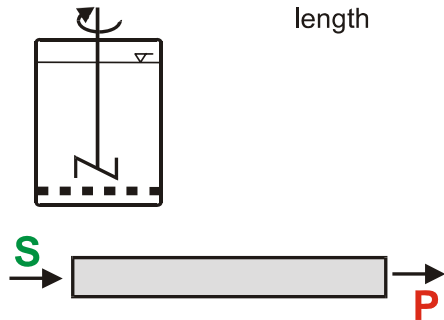
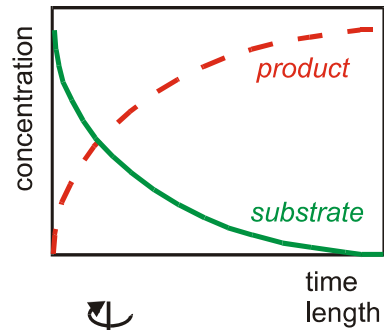

batch or plug flow

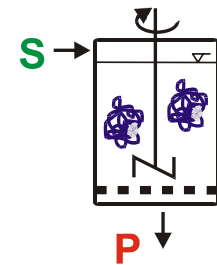
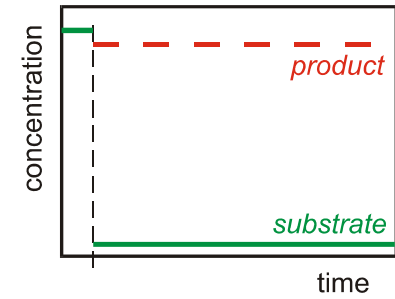
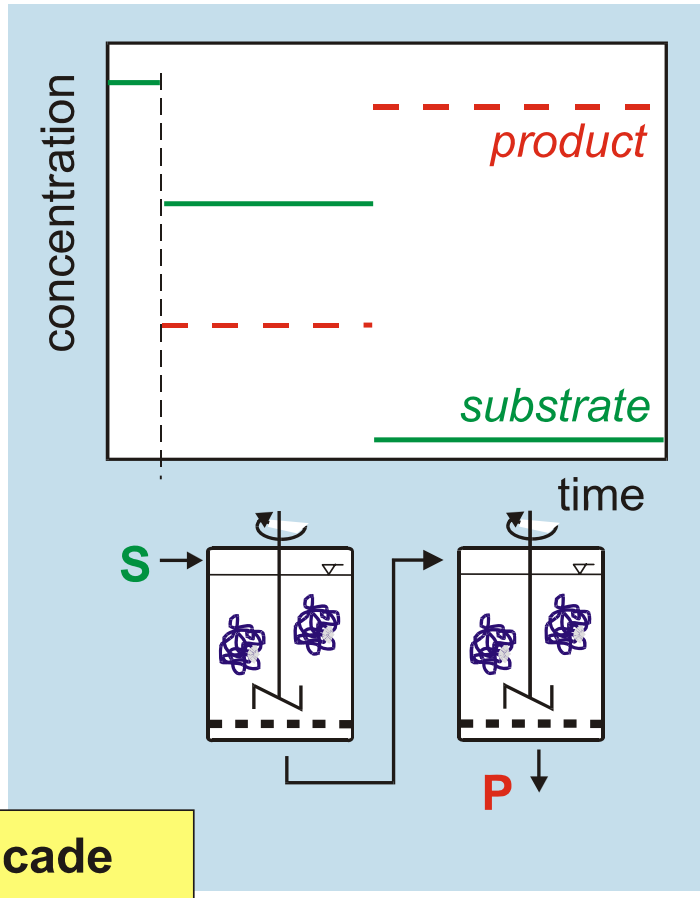

CSTR

Two-Stage CSTR-Cascade to Reduce Product Inhibition

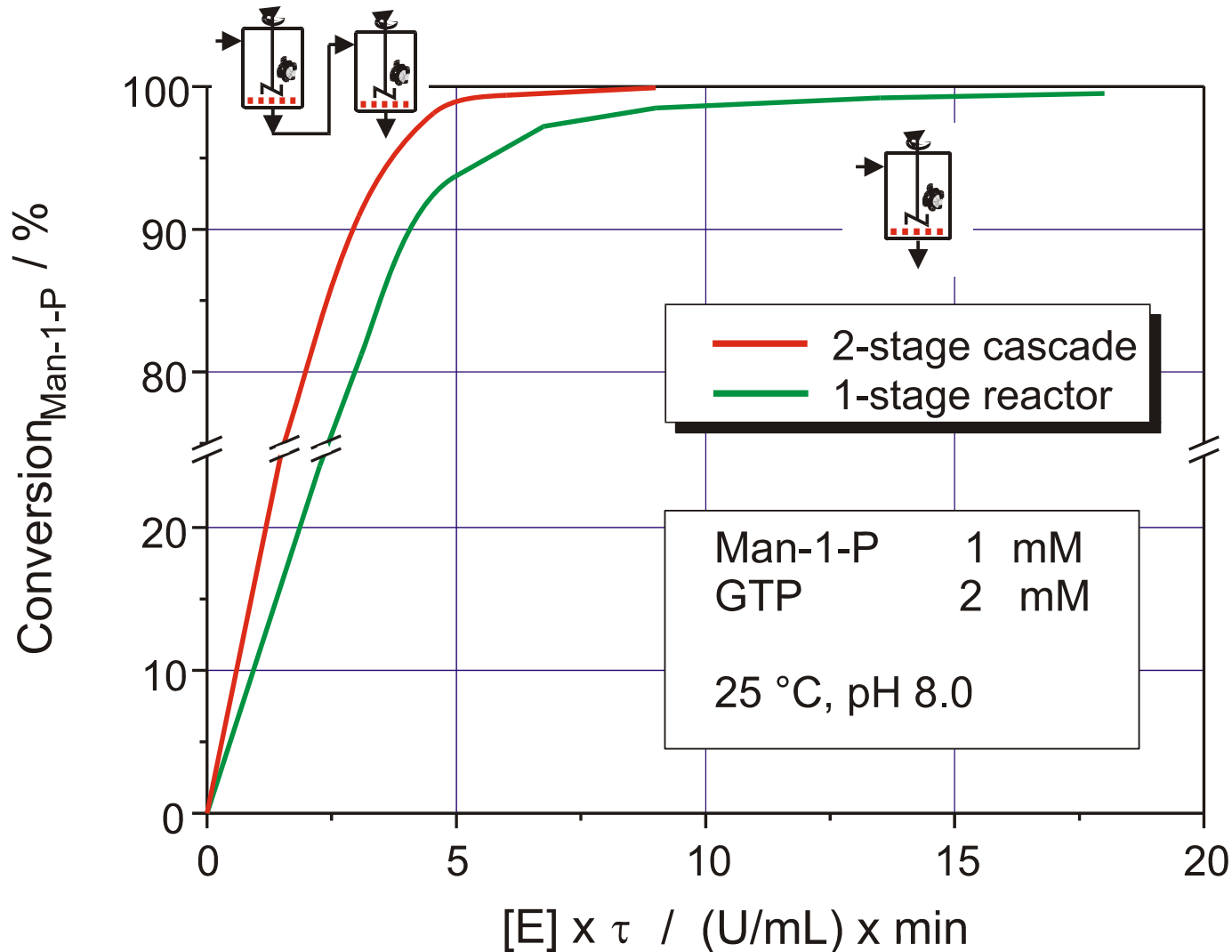

GDP-Man Production in a 2-Stage CSTR-Cascade

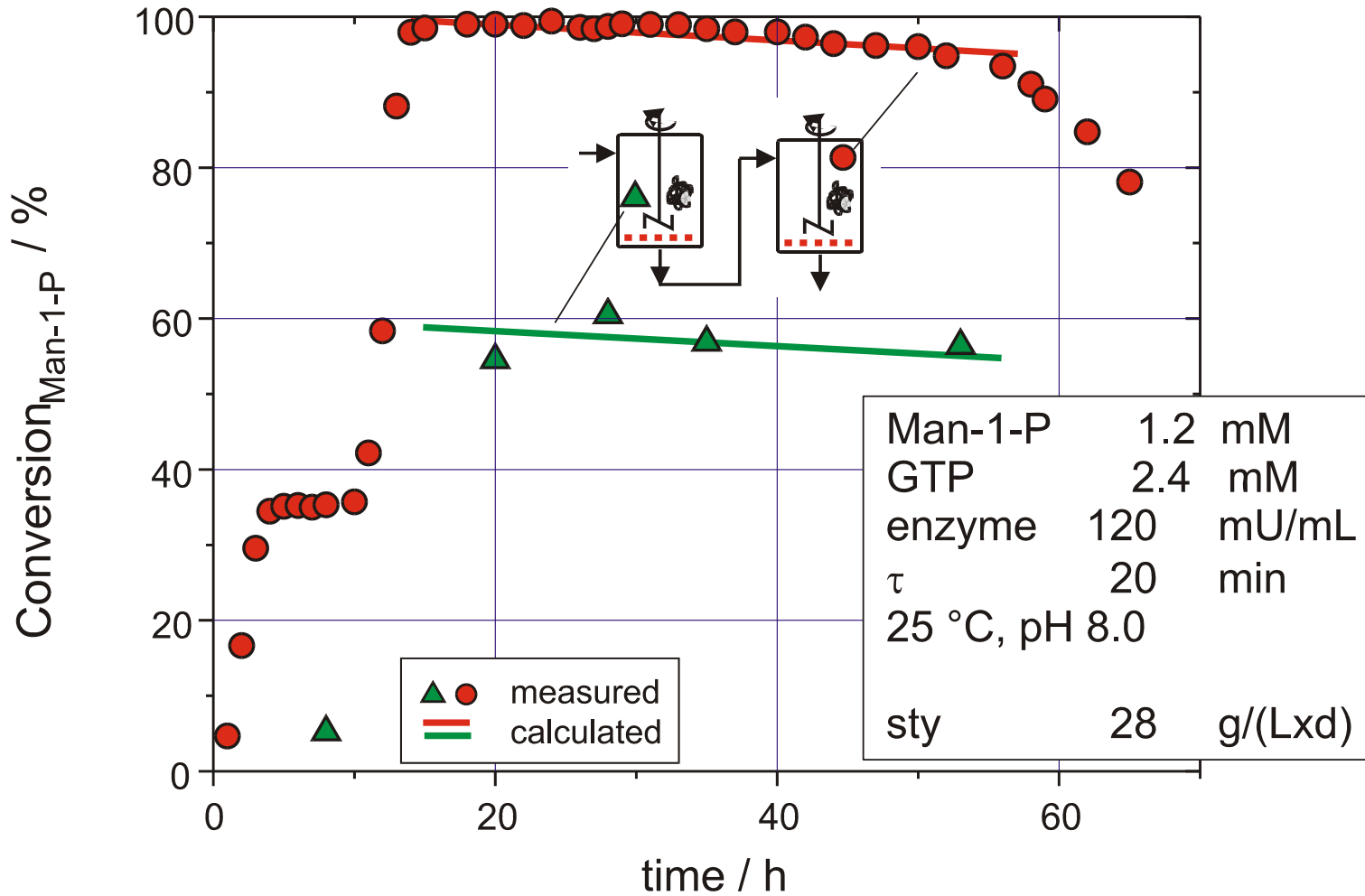

GDP-Man Production - Enzyme Consumption

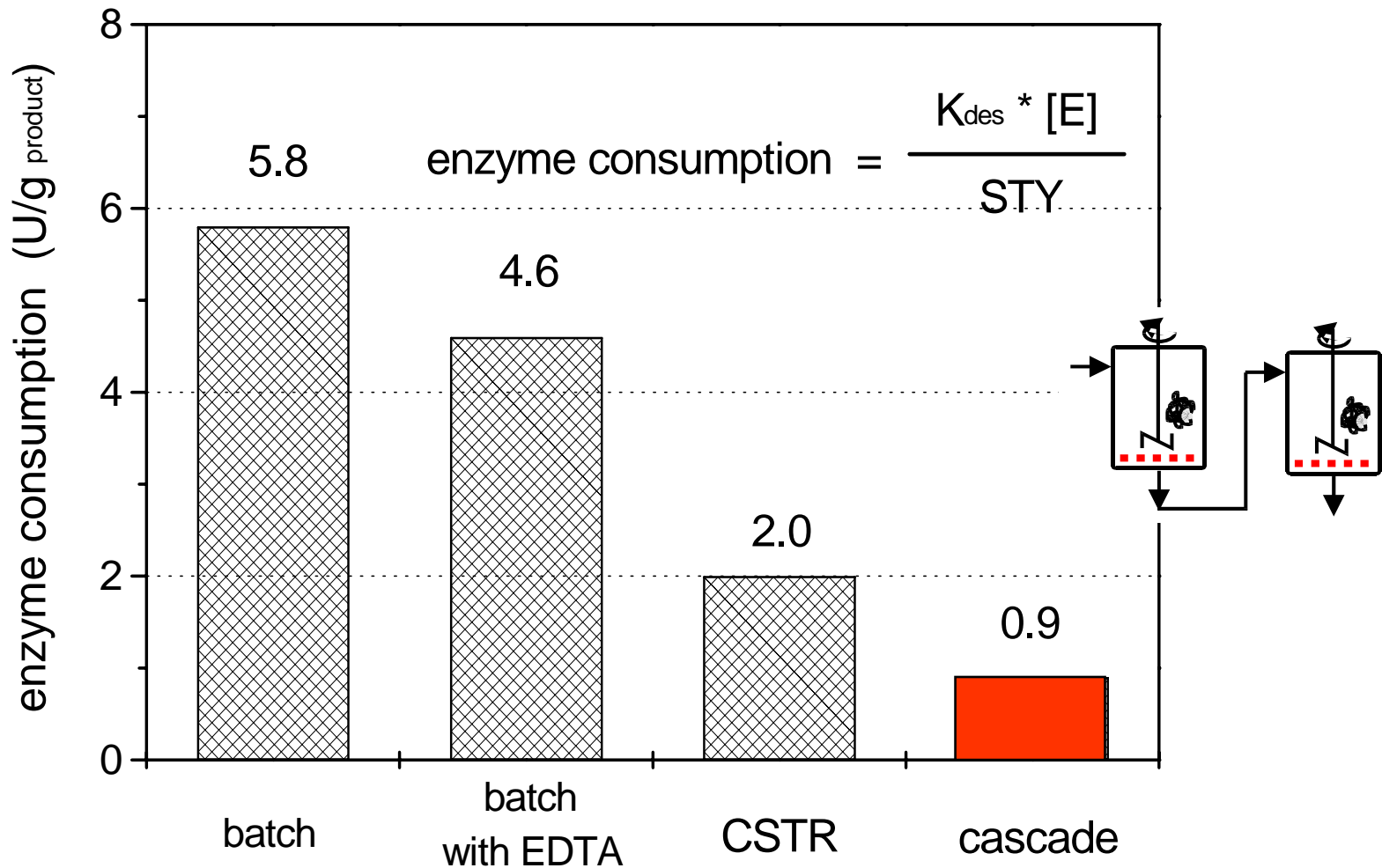

Classification of Enzymes

Ligases

bond formation under energy consumption

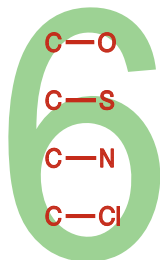

Oxidoreductases

reduction and oxidation

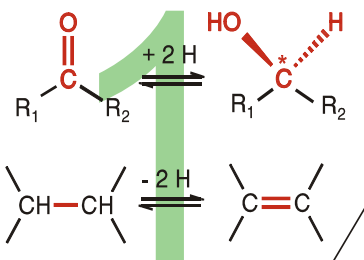

Transferases

transfer of complete groups

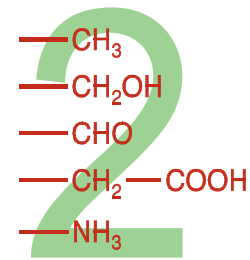

Isomerases

isomerisation and racemication



Lyases

bond formation/cleavage

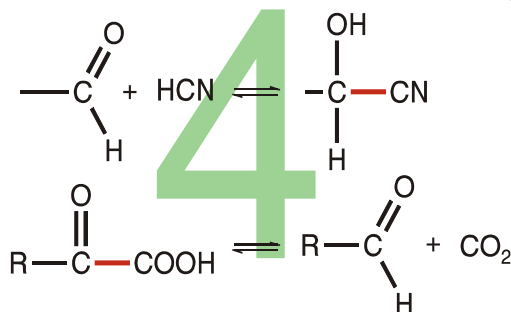

Hydrolases

cleavage under H₂O consumption

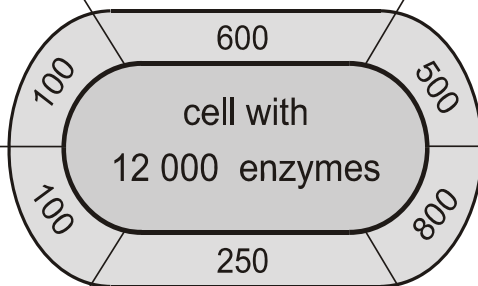
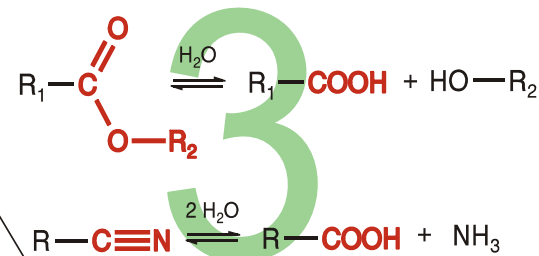

Lipase

EC 3.1.1.3

Burkholderia plantarii

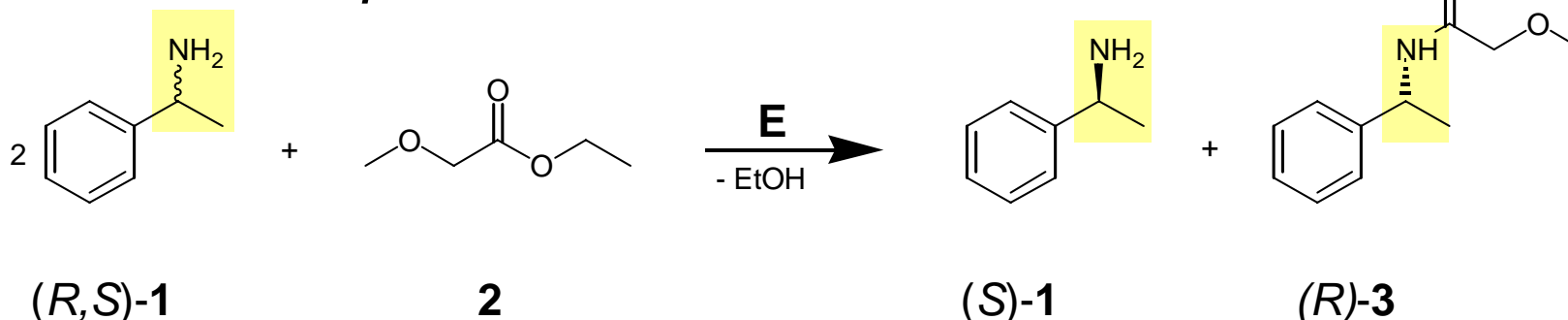

freeze drying of the enzyme solution together with fatty acids to increase enzyme activity

1 = 1-phenylethylamine
2 = ethylmethoxyacetate
3 = phenylethylmethoxyamide

BASF

reaction conditions:

process parameters:

[(R/S)-1]: 1.65 M, 200 g·L⁻¹
pH: 8.0-9.0
medium: MTBE-ethylmethoxyacetate
catalyst: **immobilized enzyme**

conversion: 50 %
yield: > 90 %
selectivity: > 500 (E-Value)
ee: > 99% (S); 93 % (R)
capacity: > 100 t·a⁻¹
residence time: 5-7 h

Flow Scheme

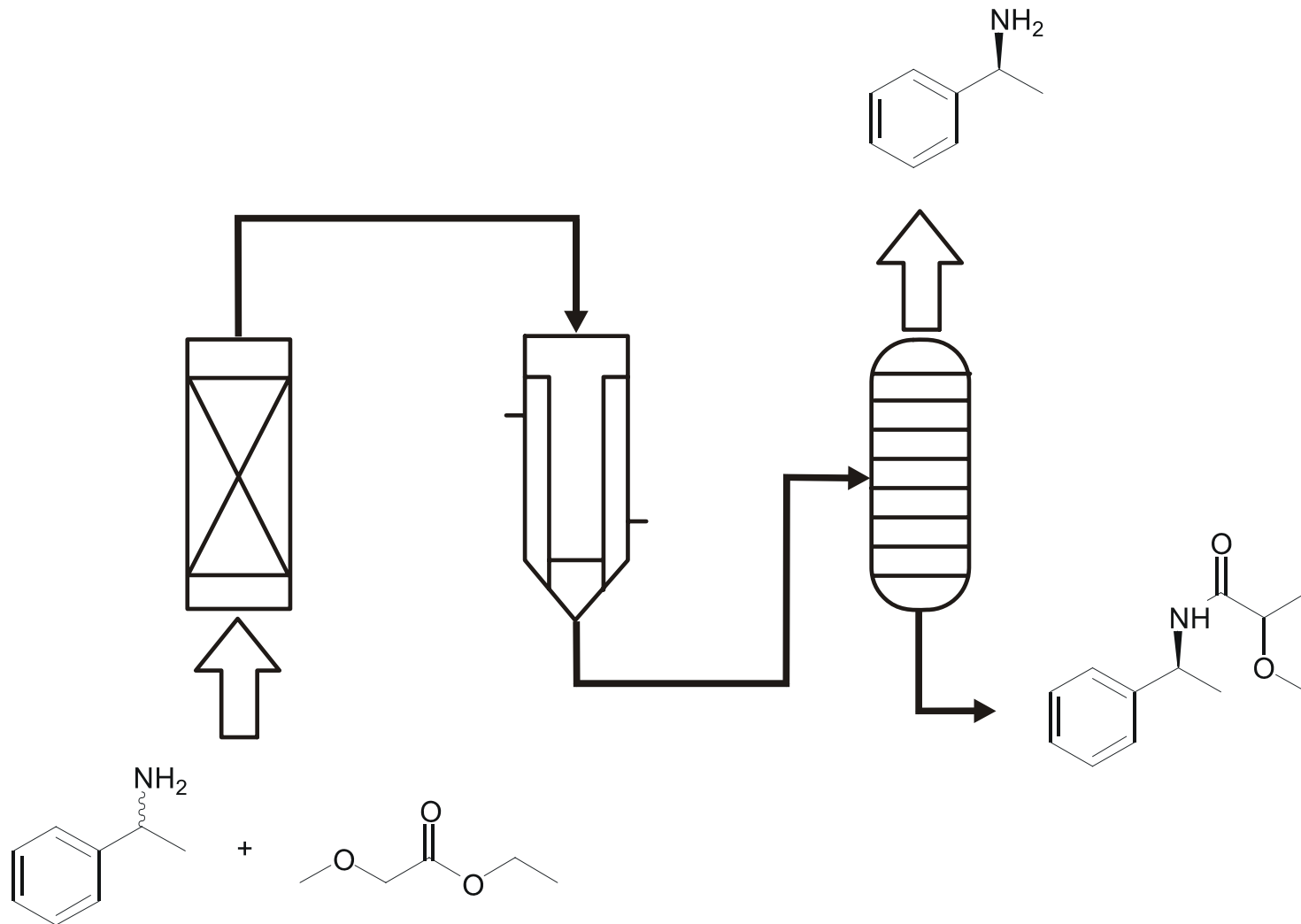

Other Starting Materials

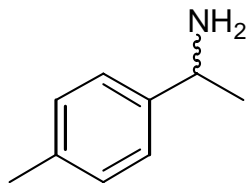

1-*p*-tolyl-ethylamine

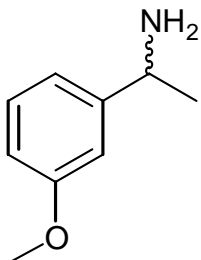

1-(3-methoxy-phenyl)-ethylamine

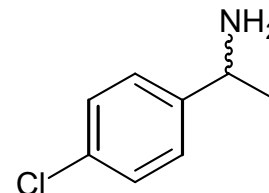

1-(4-chloro-phenyl)-ethylamine

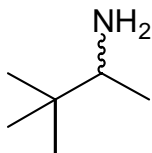

3,3-dimethyl-butyl-2-amine

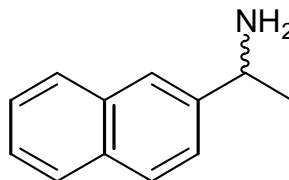

1-naphthyl-ethylamine

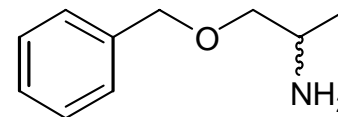

2-benzyloxy-1-methyl-ethylamine

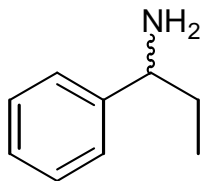

1-phenyl-propylamine

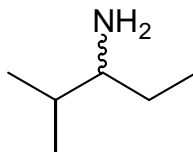

1-ethyl-2-methyl-propylamine

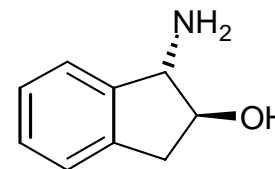

1-amino-indan-2-ol

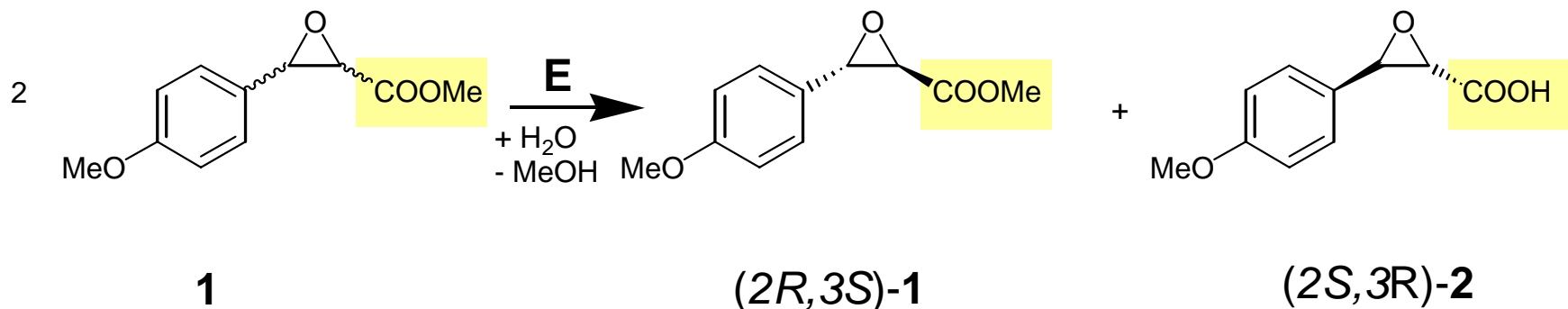
Serratia marescens

1 = 3-(4-methoxyphenyl) glycidic acid methyl ester = MPGM

2 = 3-(4-methoxyphenyl) glycidic acid

Tanabe Seiyaku Co., Ltd.

reaction conditions:

[1]: < 0.6 M, < 125 g·L⁻¹
 pH: 8.5
 T: 22 °C
 medium: aqueous/toluene
 catalyst: immobilized enzyme

process parameters:

yield: 40-45 %
 ee: 100 %
 reactor type: batch
 capacity: 40 kg (-)-MPGM / (m²·a)
 50 t a⁻¹
 start-up date: 1993

Matsumae, H., Furui, M., Shibatani, T., Tosa, T. (1994), J. Ferment. Bioeng. **78**, 59-63

Matsumae, H., Shibatani, T. (1994), J. Ferment. Bioeng. **77**, 152-158

Flow Scheme

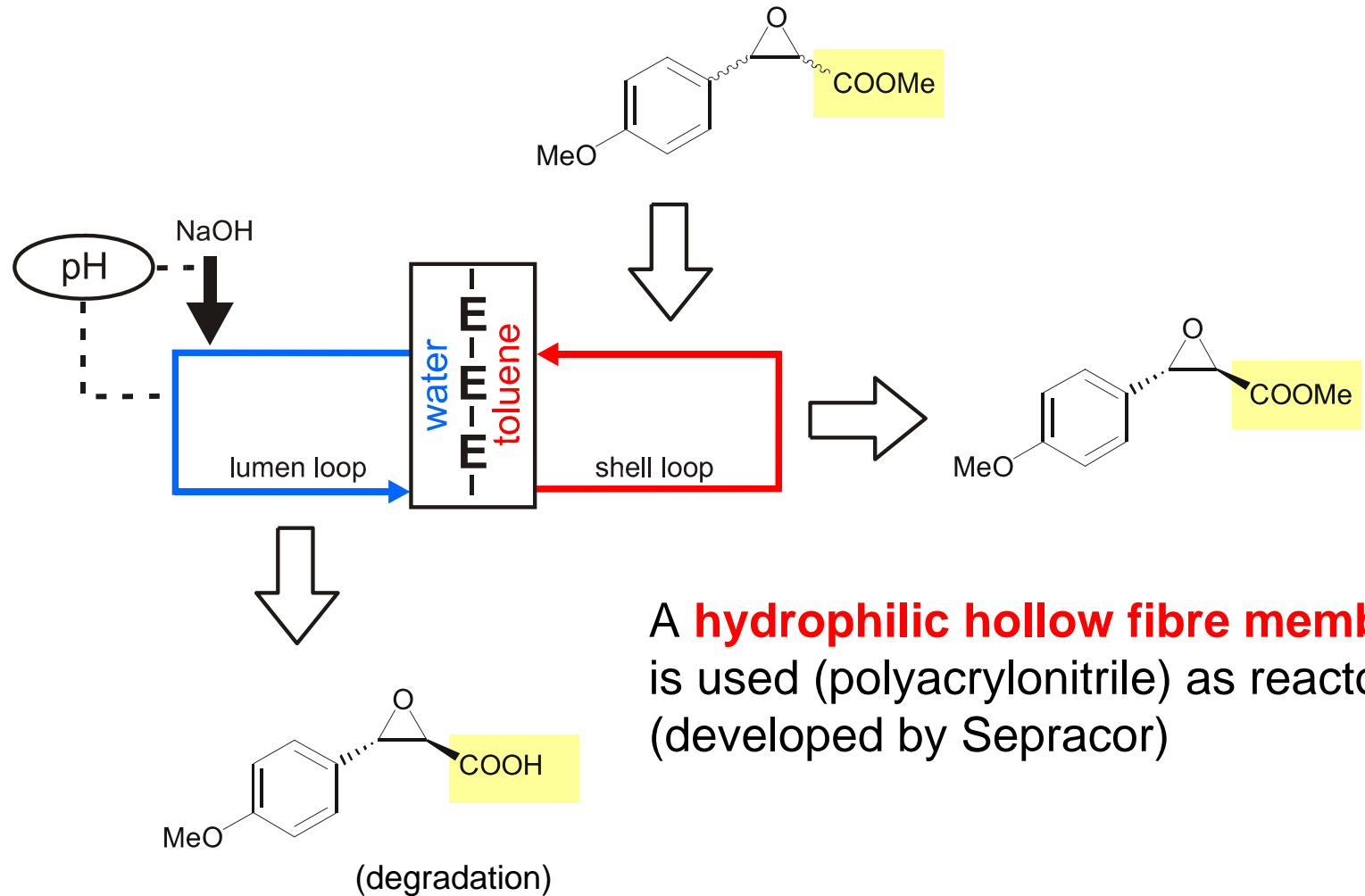

Pseudomonas putida

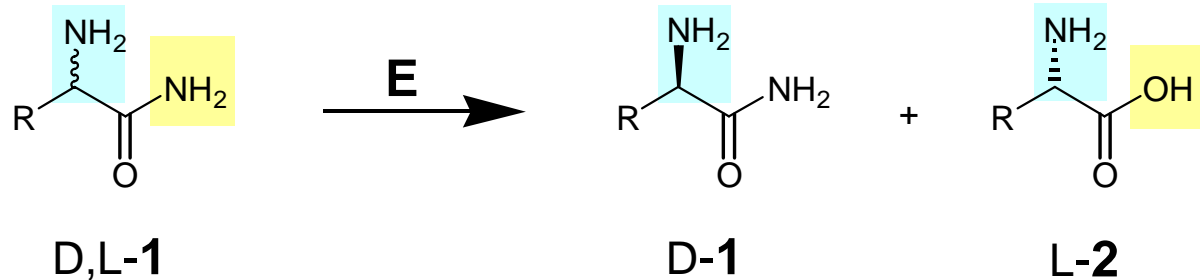

1 = α -amino acid amide
2 = α -amino acid

DSM

reaction conditions:

[1]: up to 20 g·L⁻¹
pH: 8.0 – 10.0
T:
medium: aqueous
catalyst: suspended whole cells

process parameters:

ee: > 99 %
reactor type: batch
capacity: ton scale
enzyme activity: 338,000 U·g_{protein}⁻¹
enzyme supplier: Novo Nordisk, Denmark
start-up date: 1988

“Dynamic Resolution” (not really)

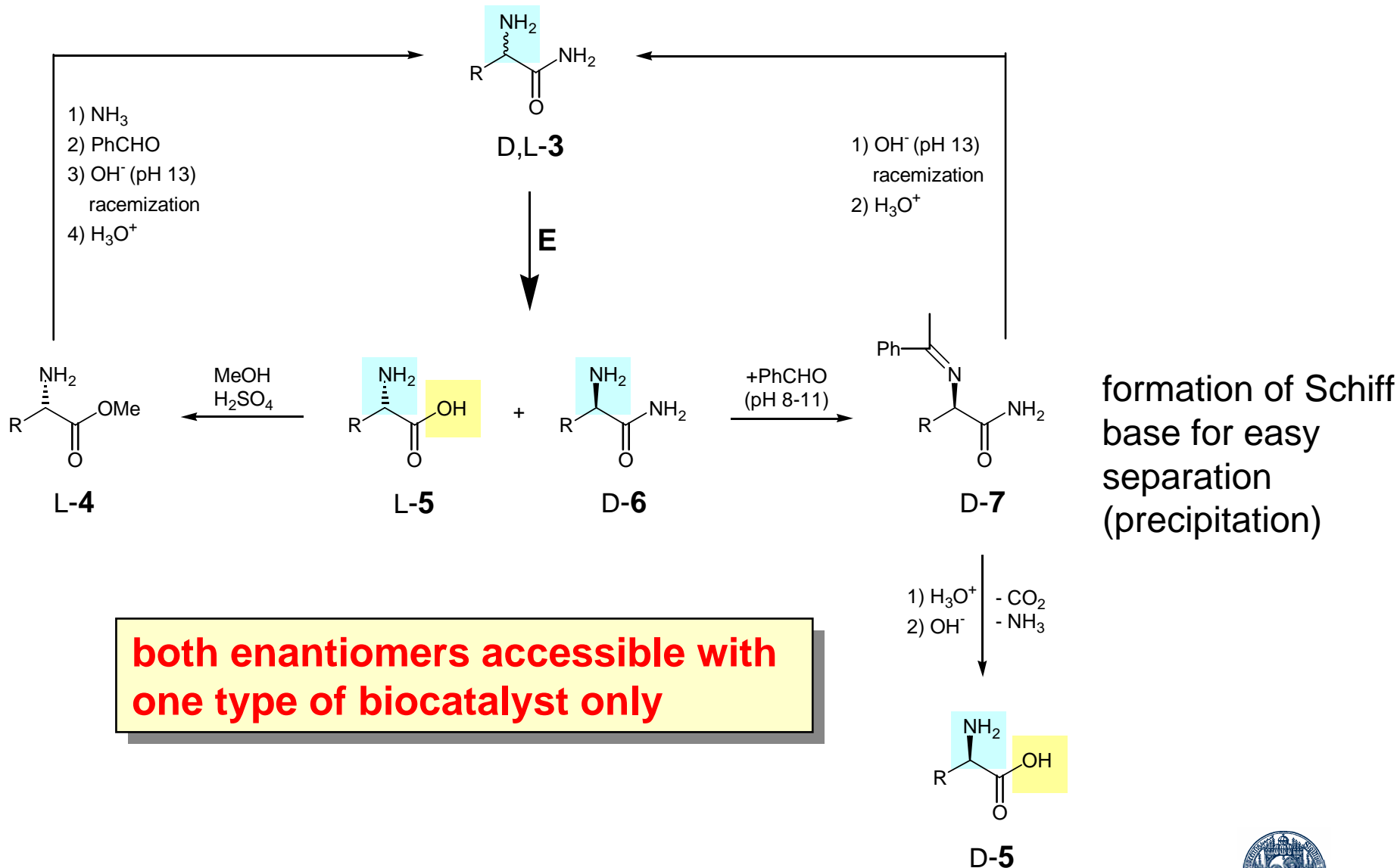

Product Application

 DSM uses the amino acids produced by this biotransformation in different product syntheses

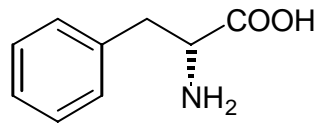

L-phenylalanine

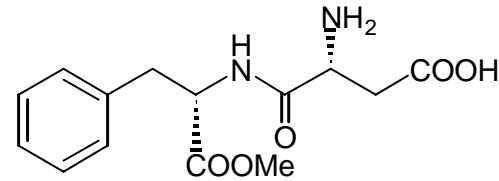

Aspartame (DSM)

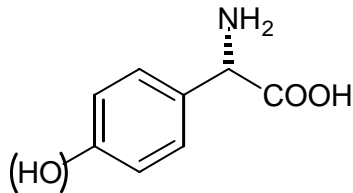

D-(p-hydroxy)phenylglycine

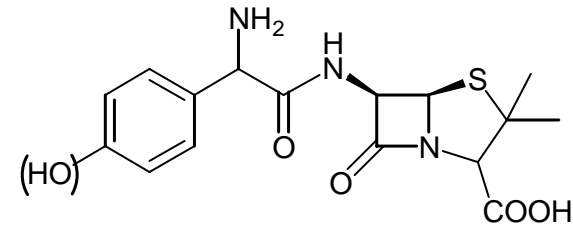

Ampicillin (Amoxicillin) (DSM)

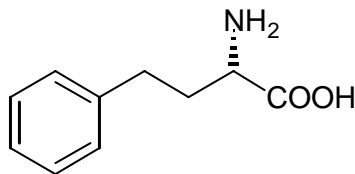

L-homophenylalanine

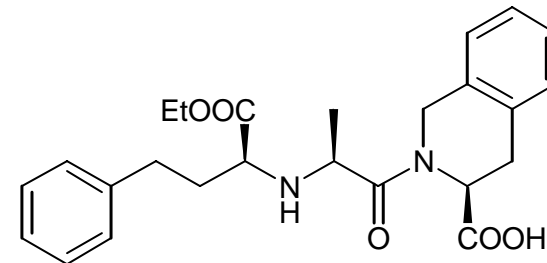

Quinapril (Warner-Lambert)

Aspergillus oryzae

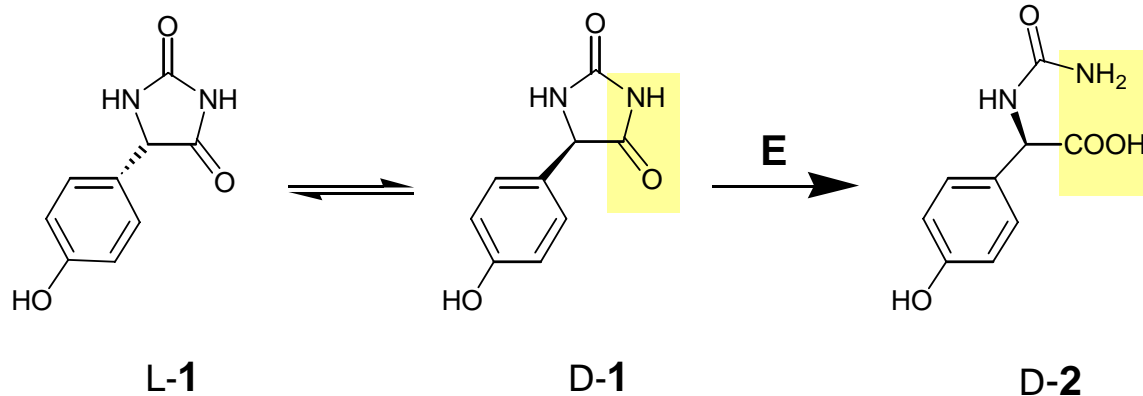

key raw material for semisynthetic penicillins and derivatives

- **unreacted L-hydantoins racemize easily under these conditions.**
- L-Specific hydantoinases are also known.

real dynamic resolution

1 = 5-(p-hydroxybenzyl)-hydantoin
2 = D-N-carbamoyl amino acid

Kanegafuchi

reaction conditions:

pH: 8.0
catalyst: immobilized whole cells

process parameters:

conversion: 100%
capacity: 200 t·a⁻¹
enzyme activity: 17.14 U·g⁻¹
start-up date: 1983

Havea brasiliensis

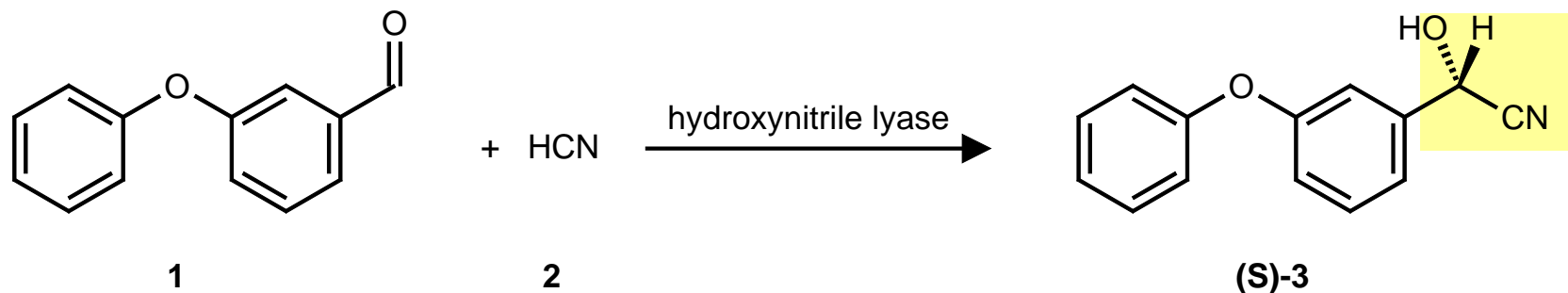

DSM Linz

(R-Oxynitrilase: Rosenthaler 1908)

reaction conditions:

[1]: 30% w/w
 [2]: 1.3 equ.
 catalyst: soluble enzyme (rec.)
 two phase system

process parameters:

reactor type: batch
 ee: **>97%**

Tyrosine Phenol Lyase

EC 4.1.99.2

Erwinia herbicola

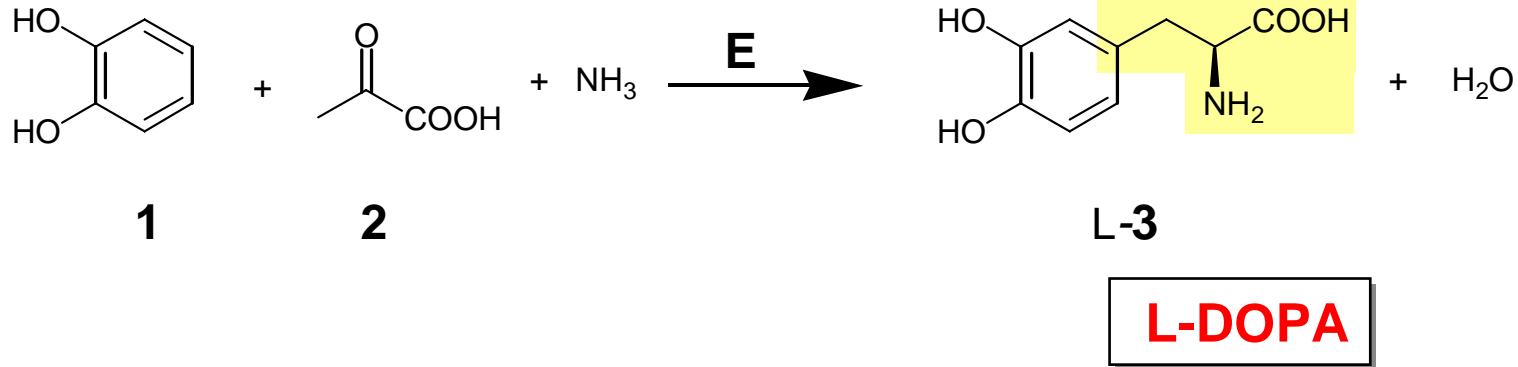

1 = catechol
2 = pyruvic acid
3 = dopa

Ajinomoto Co., Ltd.

reaction conditions:

process parameters:

[3]: 0.558 M, 110 g·L⁻¹
catalyst: suspended whole cells

reactor type: fed batch
reactor volume: 60 000 L
capacity: 250 t·a⁻¹

Tsuchida, T. et al. (1993) Ajinomoto Co., Ltd., JP 5123177A

Yamada, H. (1998), pp. 13-17, Studies in Organic Chemistry **53**, Elsevier, Amsterdam

Universität Rostock
Technische Chemie



Competing with Monsanto's Chemical Process

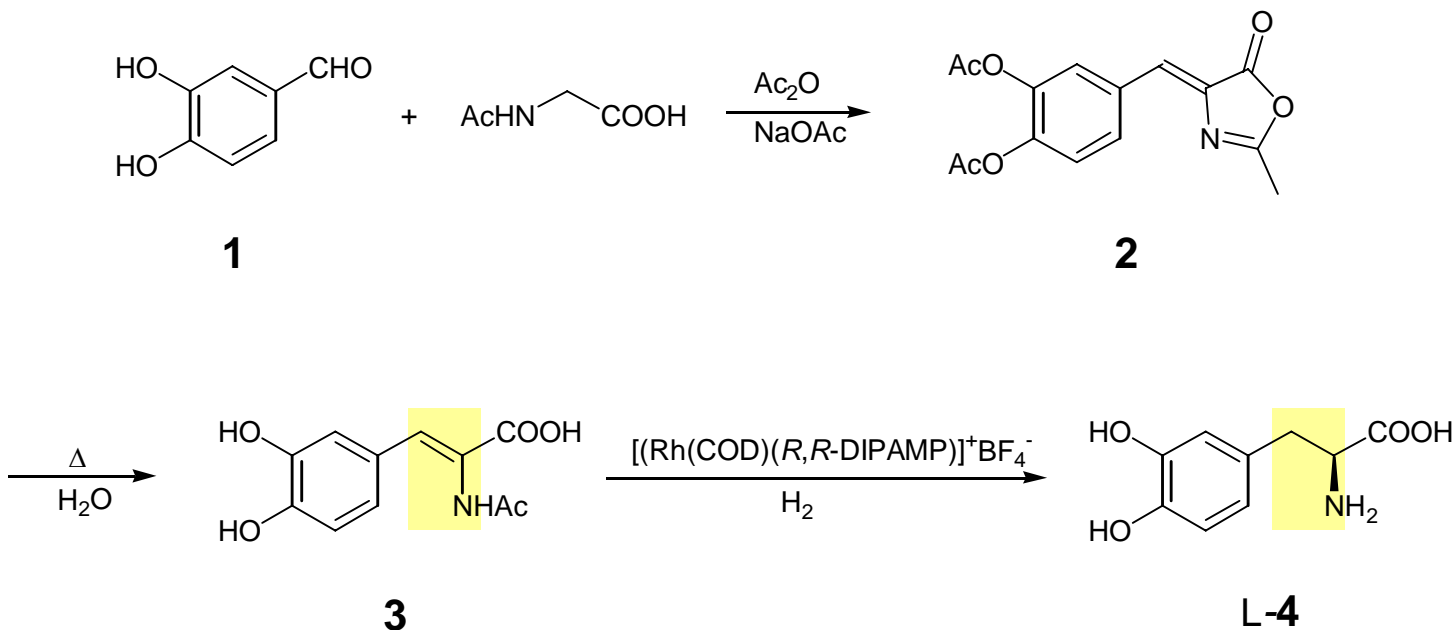

for the treatment of Parkinson

- 1 = vanillin
- 2 = hydantoin
- 3 = Z-enamide
- 3 = dopa

Rhodococcus rhodochrous

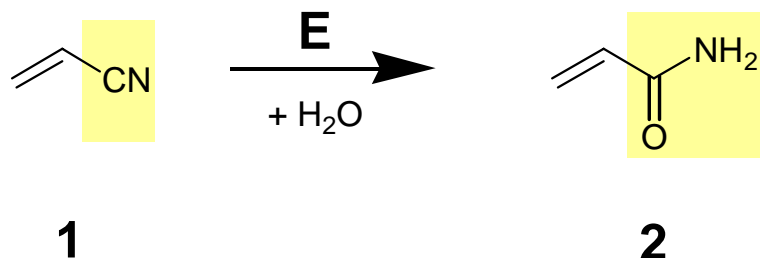

1 = acrylonitrile
2 = acrylamide

Nitto Chemical Industry

reaction conditions:

[1]: 0.11 M, 6 g·L⁻¹ (fed batch)
[2]: **5.6 M, 400 g·L⁻¹**
pH: 7.0
T: 5 °C
catalyst: immobilized whole cells

process parameters:

conversion: > 99.99 %
yield: **> 99.99 %**
selectivity: > 99.99 %
reactor type: fed batch
capacity: > 30,000 t·a⁻¹
residence time: 5 h
space-time-yield: 1.920 g·L⁻¹·d⁻¹
start-up date: 1991

Chemical Synthesis was Substituted

- The chemical synthesis uses **copper salt** as catalyst for the hydration of acrylonitrile and has several disadvantages:
 - 1) The rate of acrylamide formation is lower than the **acrylic acid formation**,
 - 2) The double bond of educt and products causes **by-product formations** such as ethylene, cyanohydrin and nitrylotrispropionamide and
 - 3) at the double bonds occur polymerization.
- The biotransformation has the advantages that recovering of unreacted nitrile is not necessary since the **conversion is 100 %** and the **no copper catalyst removal** is needed.



Product Spectrum

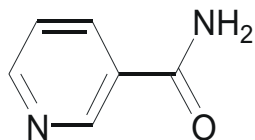

1,465 g L⁻¹

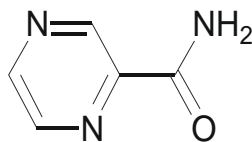

985 g L⁻¹

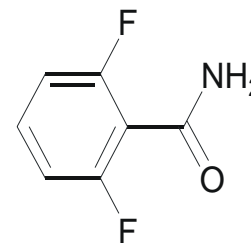

306 g L⁻¹

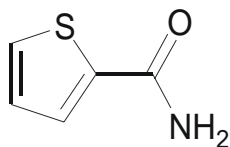

210 g L⁻¹

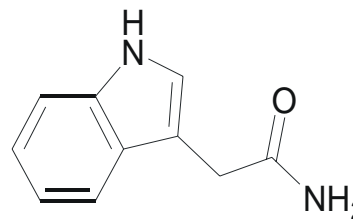

1,045 g L⁻¹

Bacillus coagulans ...

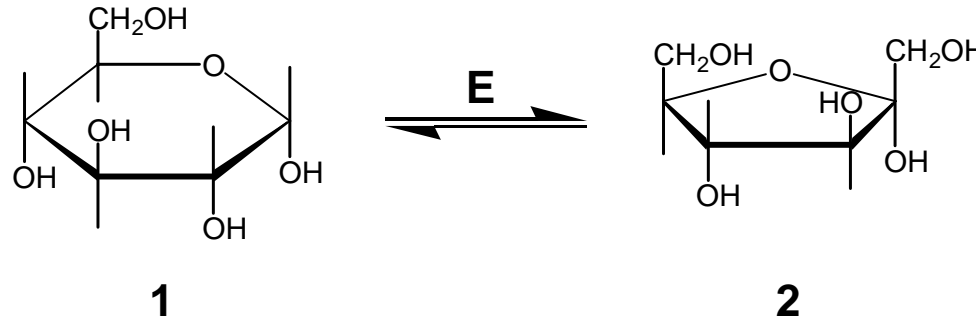

1 = glucose
2 = fructose

Novo-Nordisk
Gist-brocardes
Miles Kali-Chemie
Finnsugar
Nagase

reaction conditions:

process parameters:

[1]: > 95 % dry matter
pH: 7.5 - 8.0
T: 50 – 60 °C
reaction type: isomerization
catalyst: immobilized whole cell
 or isolated enzyme

reactor type: continuous, fixed bed
capacity: > 7·10⁶ t·a⁻¹
residence time: 0.17 – 0.33 h
start-up date: 1967 by Clinton Corn
 Processing Co. (USA)

Remarks

- Since these isomerases belong to the group of metallo enzymes, Co^{2+} and Mg^{2+} is required.
- The **reaction enthalpy is slightly endothermic and reversible**. The equilibrium conversion is about 50 % at 55 °C.
- **Several reactors are operated in parallel** or in series, containing **enzymes of different ages**. The feed to a single reactor is controlled by the conversion of this reactor.
- Plants proceeding more than 1000 t of HFCS (based on dry matter) per day typically use at least 20 individual reactors.
- The product HFCS contains 42 % fructose (53 % glucose) or 55 % fructose (41 % glucose)(dry matter).

Flow Scheme

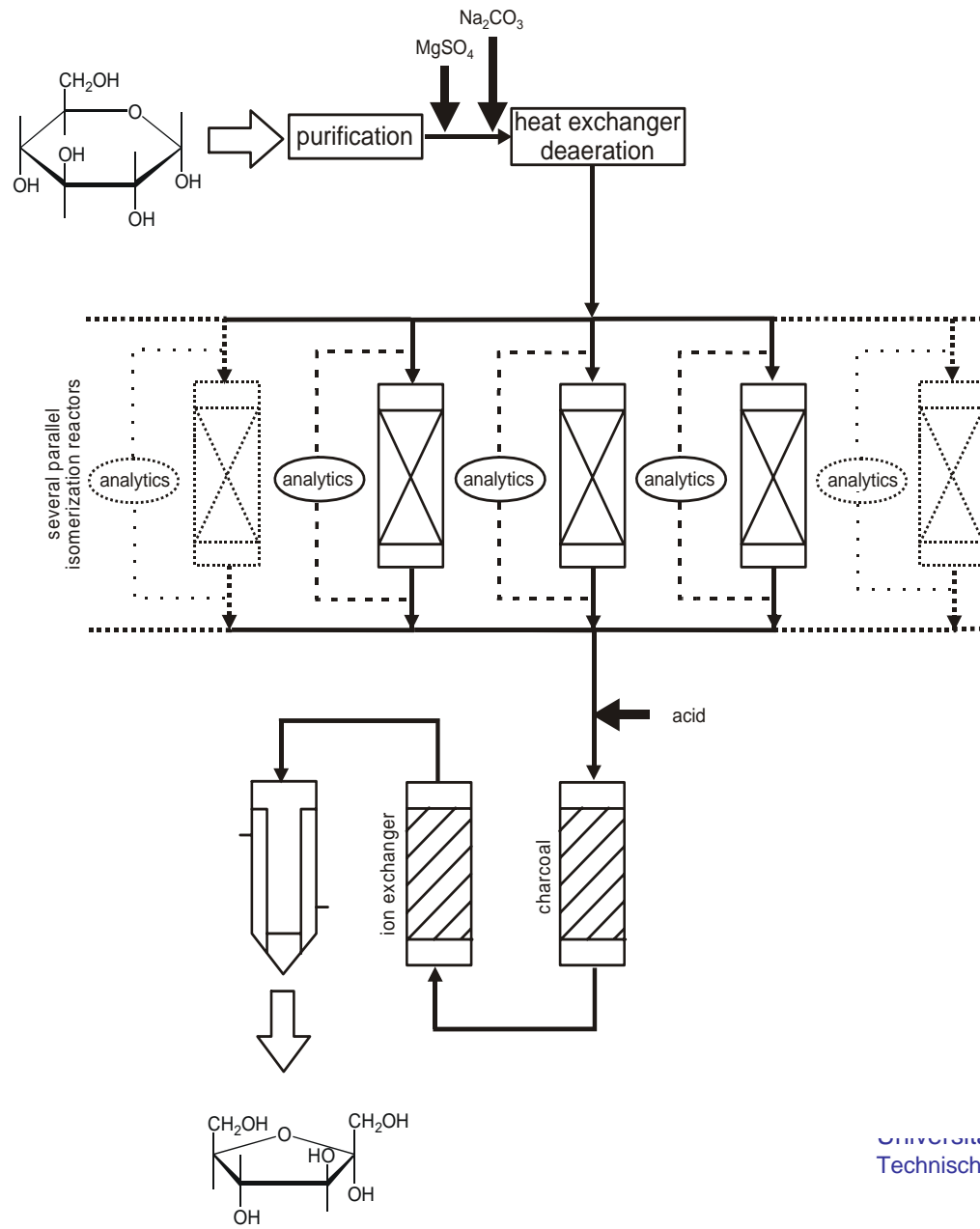

Other Applications of Enzymes

purpose

type

washing powder

proteases, lipases etc.

food technology

pectinases, amylases

textile industry

leather, „biobleaching“

biosensors

glucose oxidase

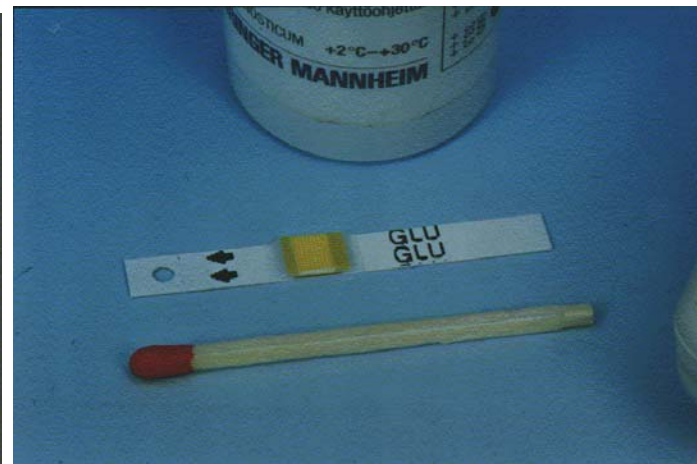

Process Development & Improvement

- modification of biocatalyst by genetic engineering**

- rational protein design
- directed evolution

Review: M. Pohl, U. Bornscheuer, *Curr. Opin. Chem. Biol.* **5**, 37 (2001)

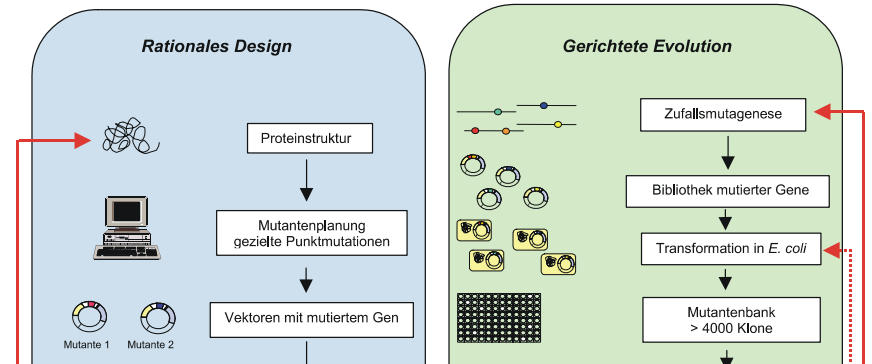

- biochemical engineering**

- reactor design (to overcome product inhibition)
- outline of process

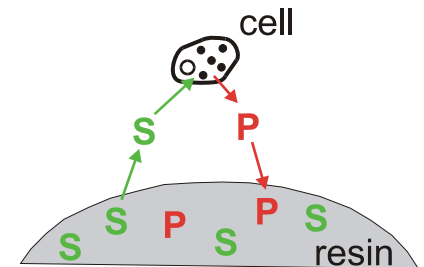
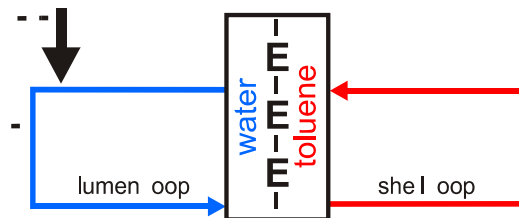

→ novel approaches such as Ionic Liquids

Alcohol Dehydrogenase for Production of Chiral Alcohols

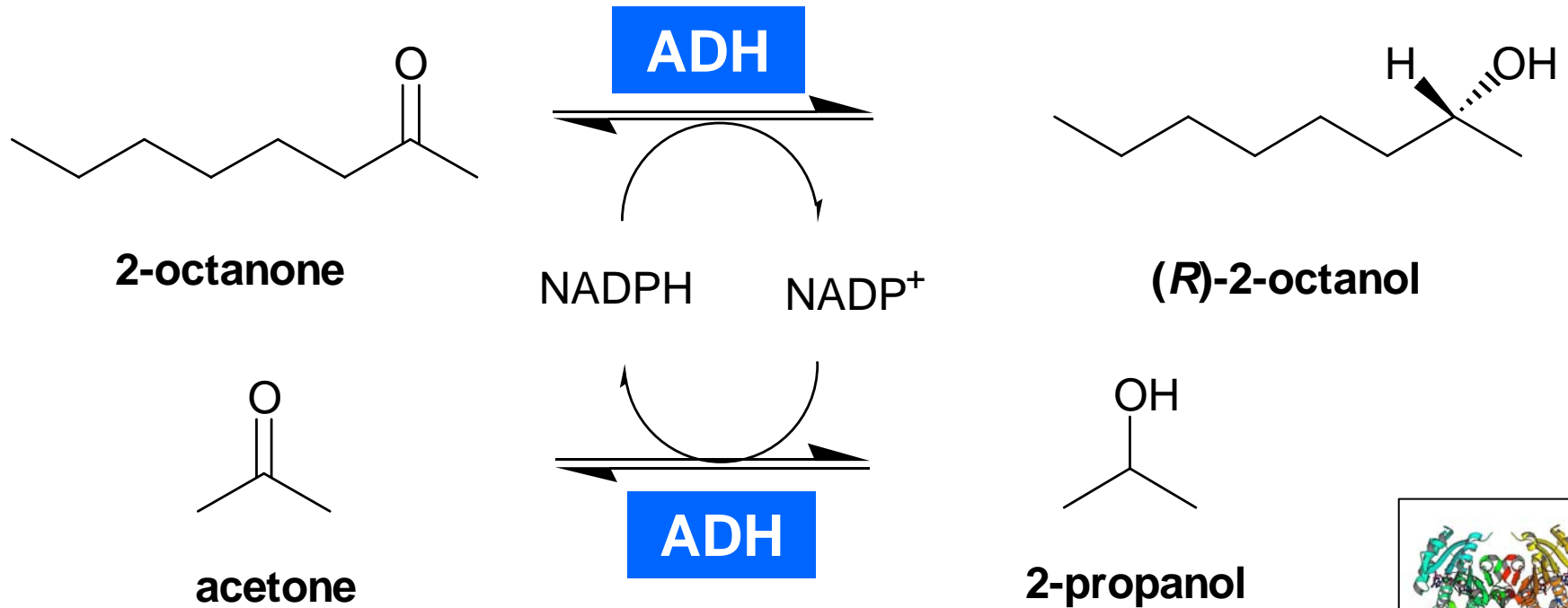

- rec ADH from: *Lactobacillus brevis* → (R)-alcohol
Thermoanaerobium spec. → (S)-alcohol
- used for production of **chiral alcohols on 10 - 100 kg scale**
eg (R)-ethyl 3-hydroxybutyrate or (R)-2-octanol

Solubility of 2-Octanone / 2-Octanol

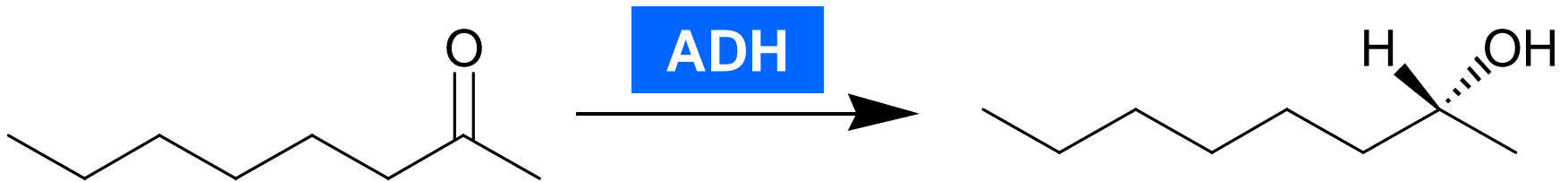

**water-solubility:
1.1 g/L**

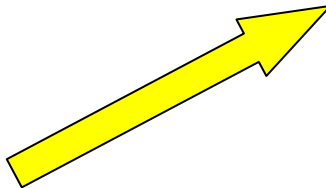

addition of water-soluble organic solvent
→ **one phase system**

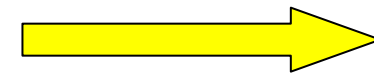

pure organic solvent
(mainly lipases)

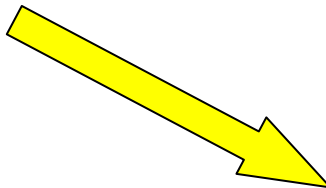

water + organic solvent
→ **two phase system**

MTBE for Two-Phase Enzymatic Reduction

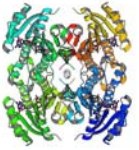

Partition coefficients MTBE / H ₂ O	
2-propanol	1.0
acetone	1.1
2-octanone	> 100
2-octanol	> 100

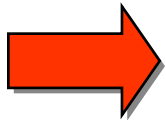
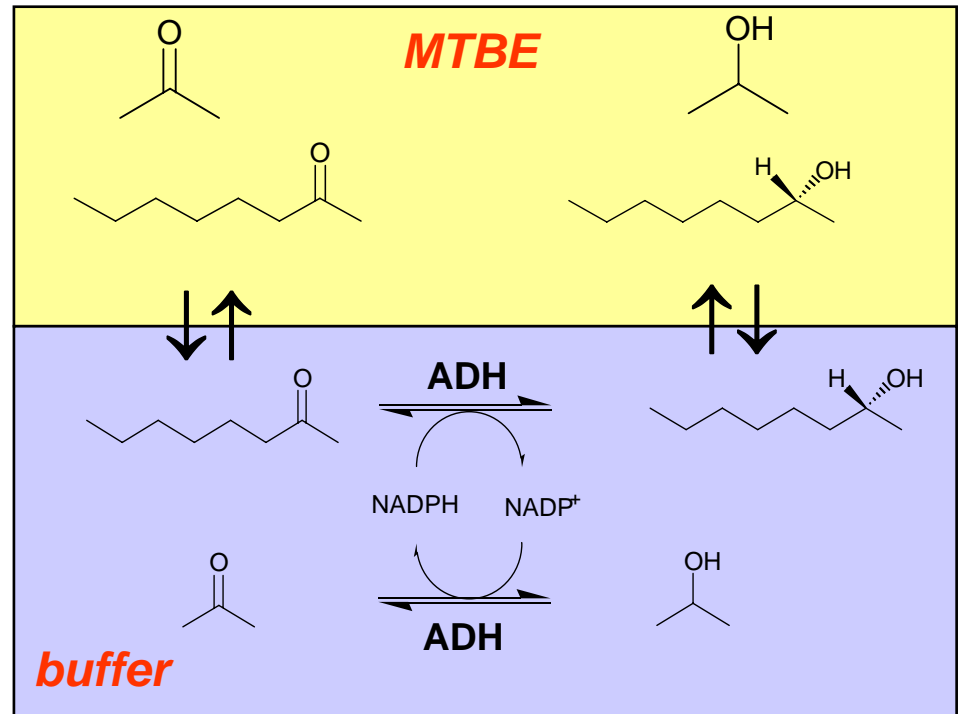

- thermodynamic equilibrium
- distribution between phases
- excess of 2-propanol is necessary

High Excess of Regeneration Substrate Necessary

two phase

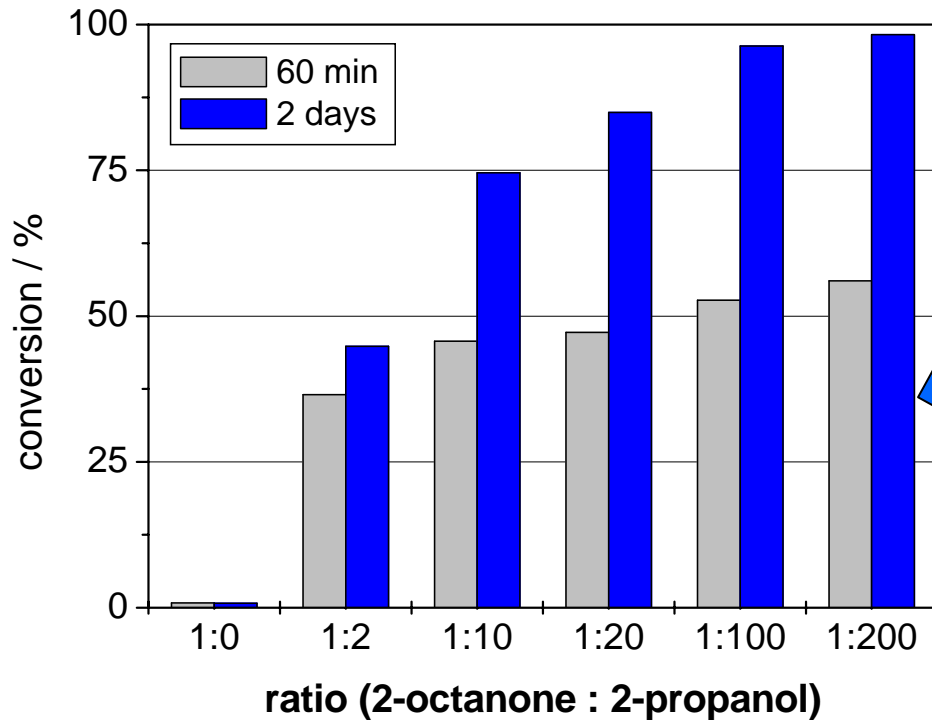

max. conversion = 98 %
in 24 h

MTBE / buffer
10 mM 2-octanone
2 M 2-propanol
30 °C
2.5 ml each phase

ADH

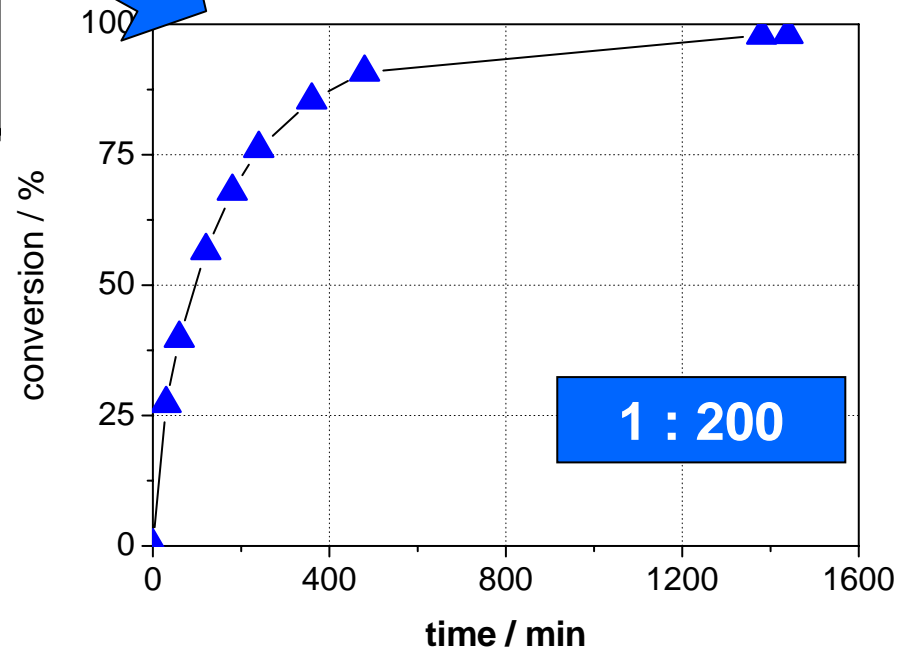

Favorable Partition Coefficient when Using an IL



Partition coefficients solvent / H₂O

	MTBE	IL
2-propanol	1.0	0.4
acetone	1.1	2.0

[BMIM] [(CF₃SO₂)₂N]
[BMIM] [BTA]

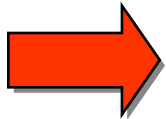
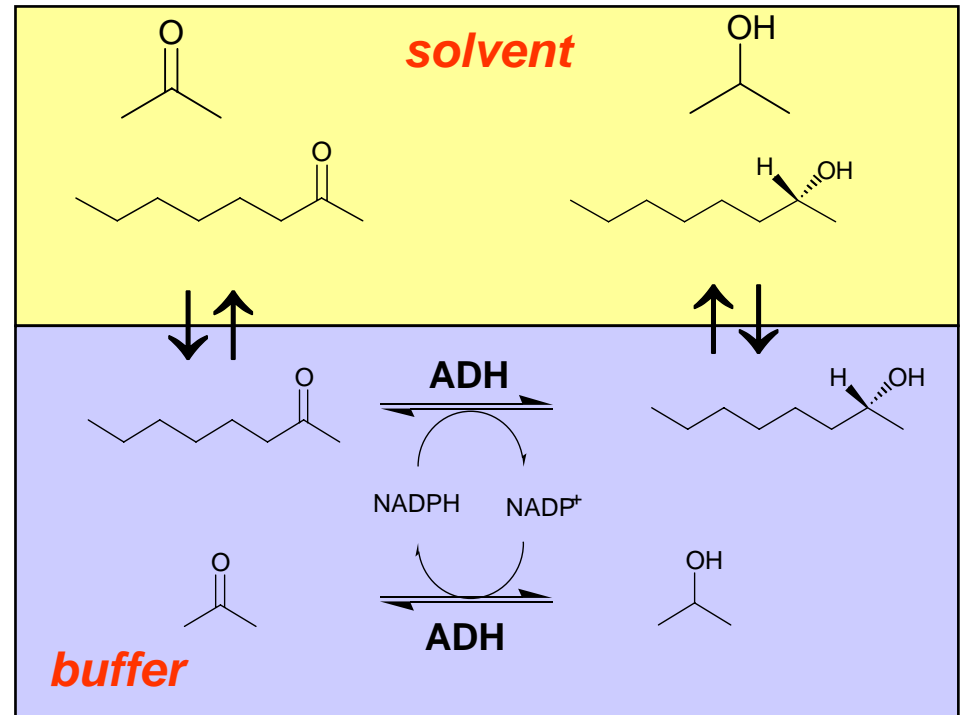

- regeneration substrate stays in water phase
- regeneration product removed from water phase
→ reduction of product inhibition

Increased Productivity of Octanone Reduction

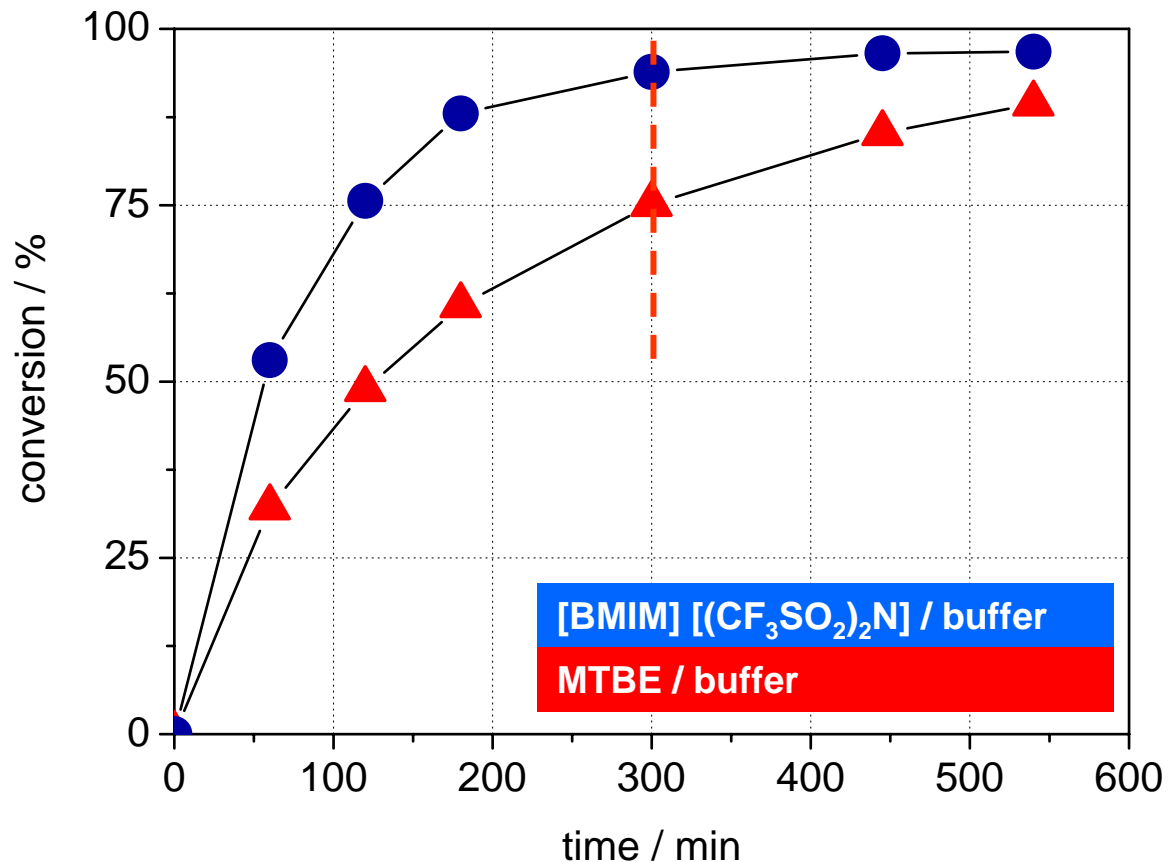

- **higher reaction velocity** due to reduced product inhibition
- in both cases max. conversion 95-98 %

Second enzyme for cofactor regeneration

two phase

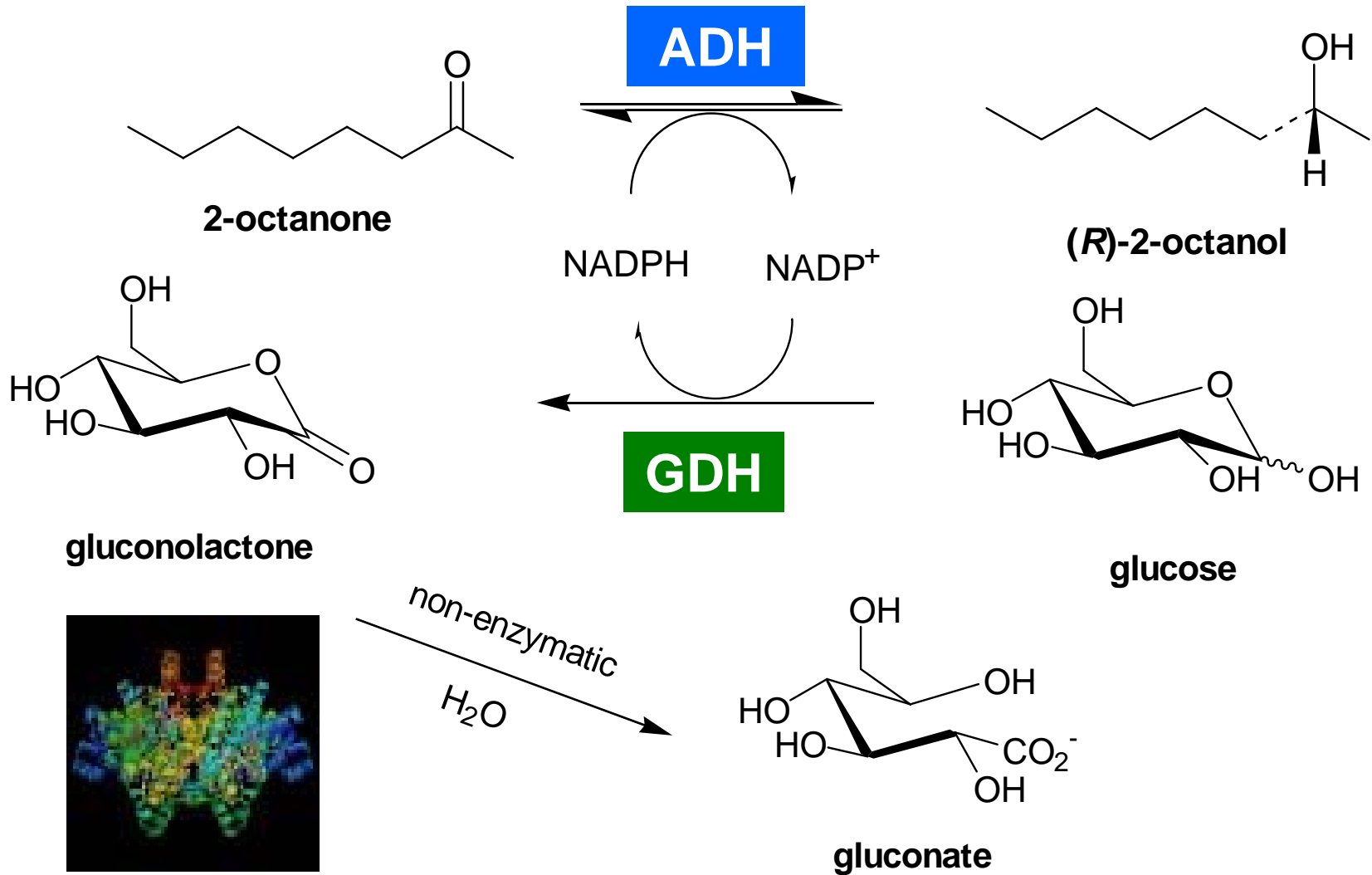

Enzyme-coupled cofactor regeneration

Partition coefficients MTBE / H ₂ O	
glucose	-
gluconate	-
2-octanone	> 100
2-octanol	> 100

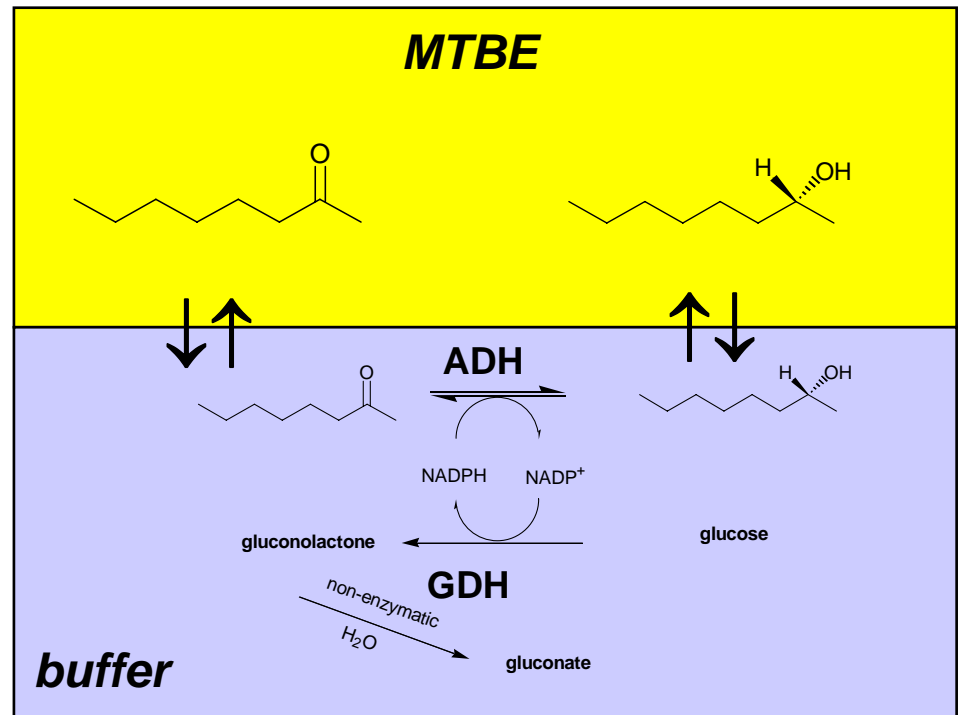

- irreversible cofactor regeneration
- glucose / gluconate stay in aq. phase

Reduced excess of regeneration substrate

two phase

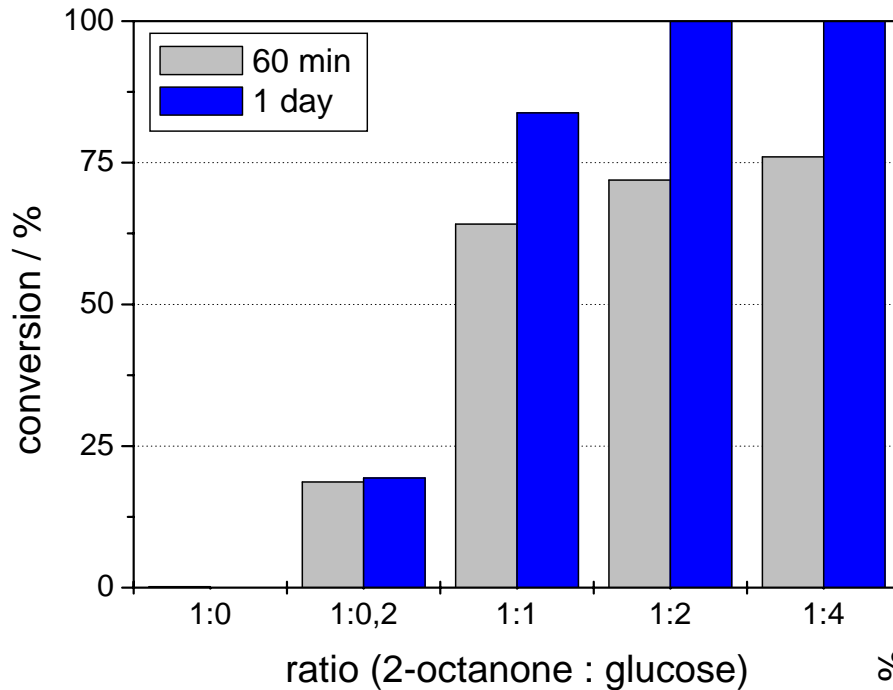

max. conversion >99 %
in 6 h

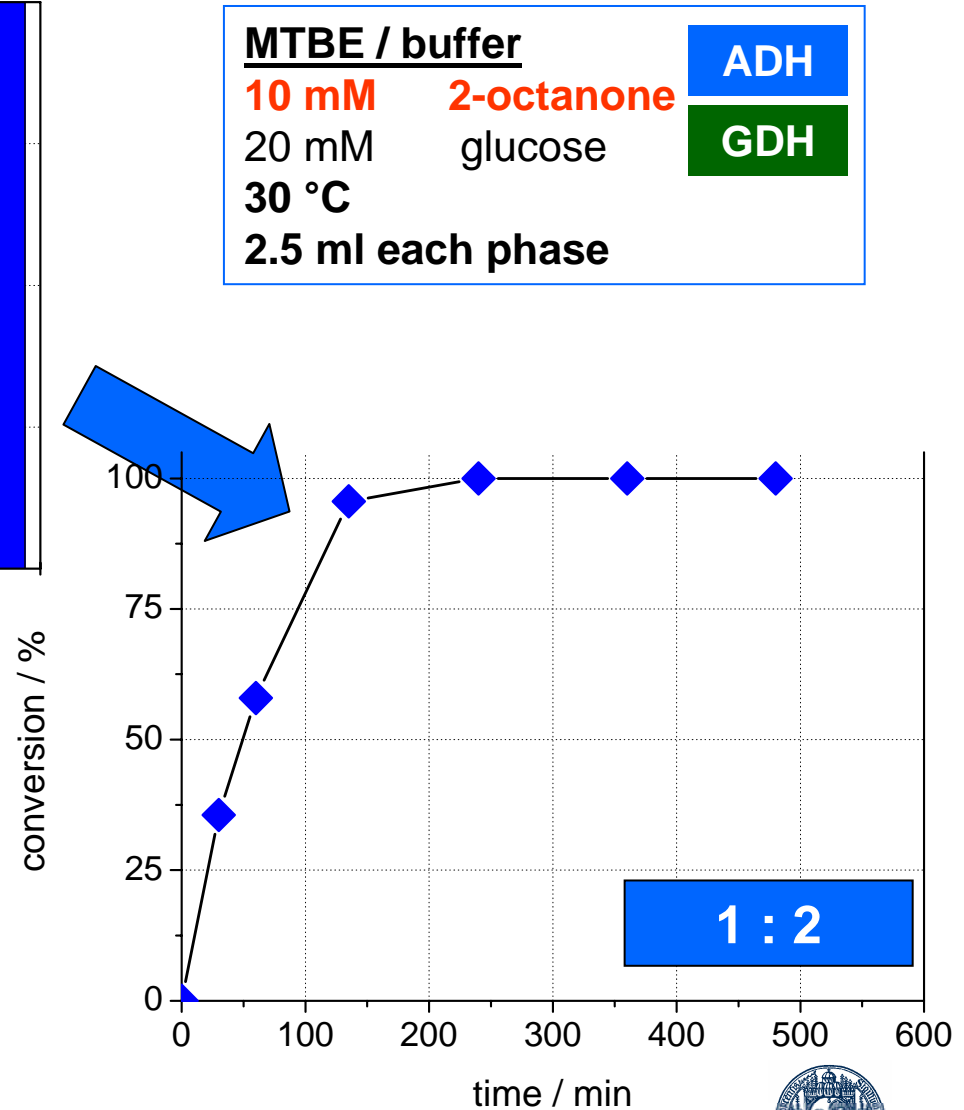

MTBE / buffer

10 mM 2-octanone

20 mM glucose

30 °C

2.5 ml each phase

ADH

GDH

Increasing the substrate concentration

two phase

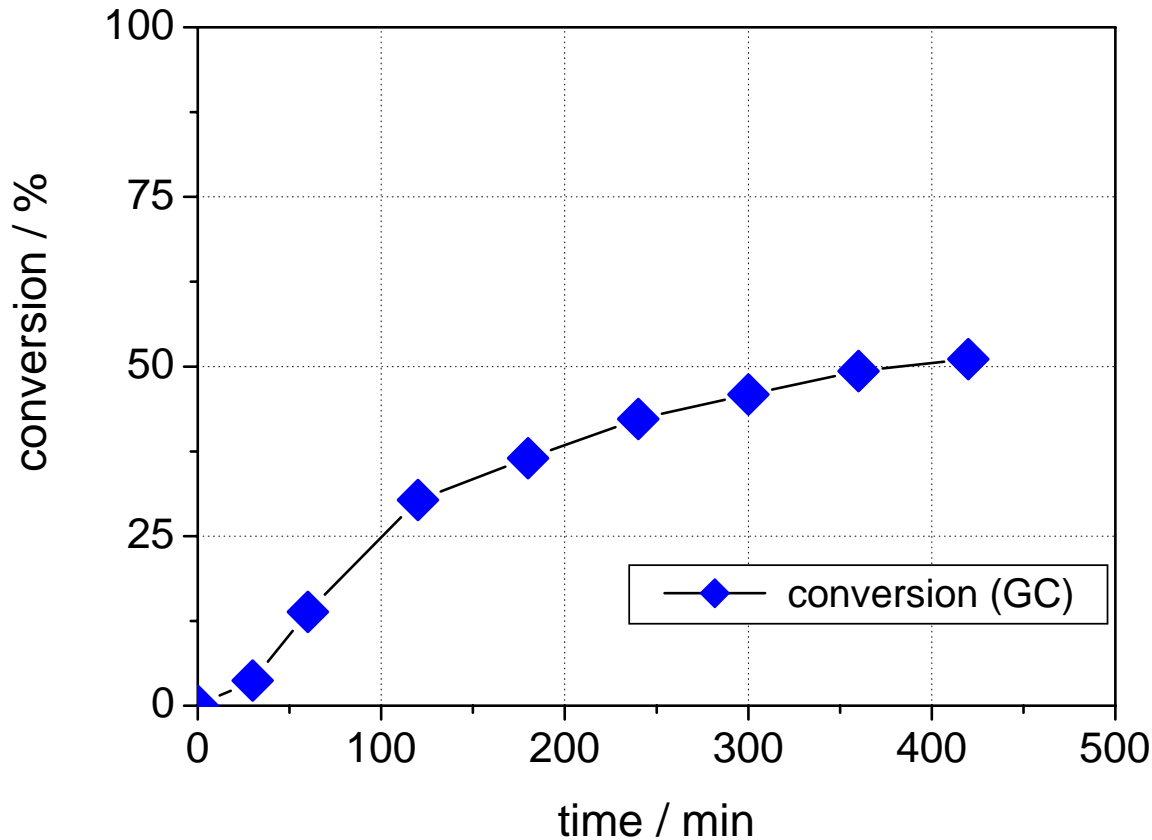

MTBE / buffer

100 mM 2-octanone

200 mM glucose

30 °C

2.5 ml each phase

ADH

GDH

Increasing the substrate concentration

two phase

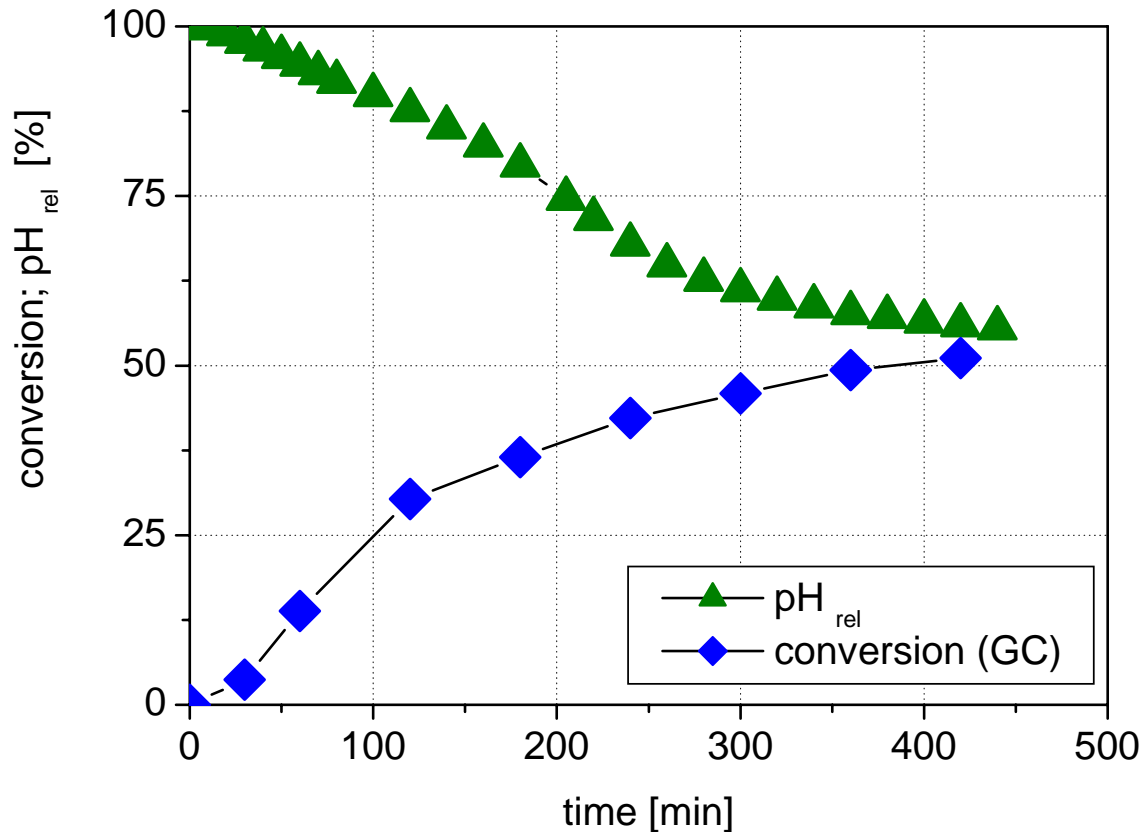

MTBE / buffer
100 mM 2-octanone
200 mM glucose
30 °C
2.5 ml each phase

ADH

GDH

end of reaction
pH ~ 3.8

Scale up

two phase

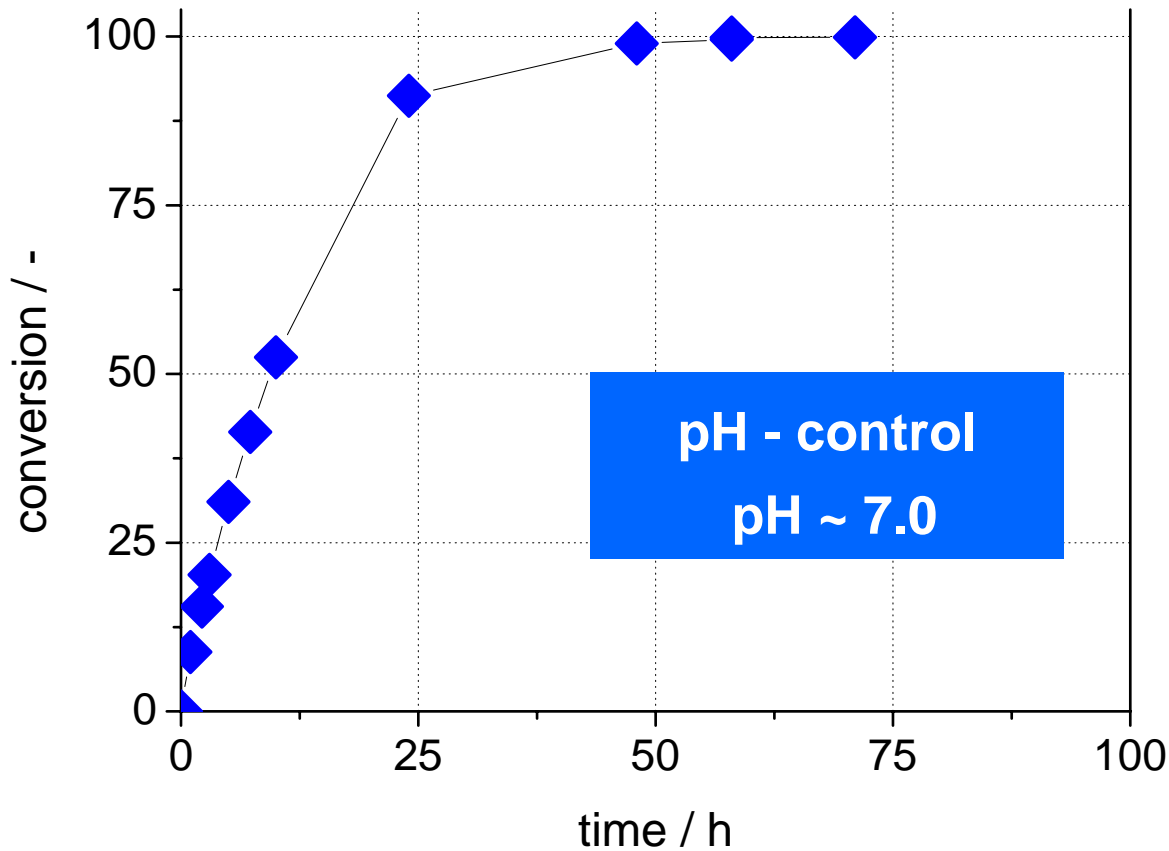

MTBE / buffer

400 mM 2-octanone

500 mM glucose

30 °C

100 ml each phase

ADH

GDH

pH - control
pH ~ 7.0

max. conversion = 99.9 %
~ 4.5 ml product
isolated yield after distillation ~72 %
space time yield 50 g/(L×d)



Take Home Message

- Biotransformations are gaining importance due to their better **selectivity** and „**cleaner**“ reaction conditions.
They replace and complement chemical processes.
- Measures have to taken to meet **special properties** and **requirements** of biocatalysts (product inhibition, toxicity).
- More than **100 industrial biotransformations** known
 - most of them use **hydrolases**.
 - **oxidoreductases** often as whole cells (cofactor!).
- Biotransformations are possible in **organic solvents & IL´s**.
- **Protein metabolic engineering** for improved
 - availability.
 - selectivity and specificity

‘Bacteria are capable of bringing about chemical reactions of amazing variety and subtlety in an extremely short time... Many bacteria are of very great importance to industry where they perform tasks which would take much time and trouble by ordinary chemical methods.’

<Sir Cyril Hinshelwood, 1956>

(The New Scientist, 1st issue 22 Nov. 1956)

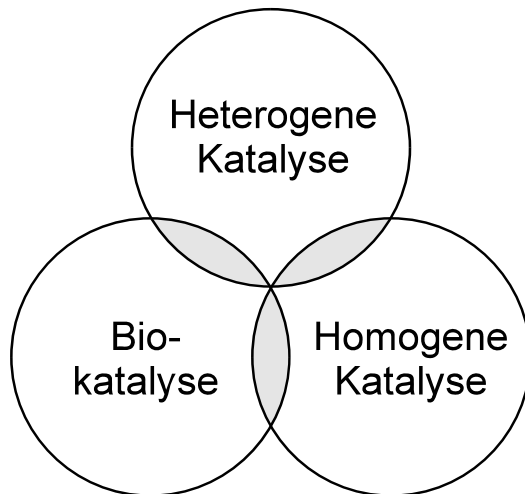



U. Kragl, Universität Rostock, D-18051 Rostock

Albert-Einstein-Str. 3A
D-18059 Rostock
Tel. 0381-498-6450
Fax. 0381-498-6452
Email udo.kragl@uni-rostock.de

Biocatalysis - References

10.01.2008

- Bailey, J. E.; Ollis, D. F.; 1986;** Biochemical Engineering Fundamentals, McGraw-Hill, New York.
- Bisswanger, H. 1994;** Theorie und Methoden der Enzymkinetik. Verlag Chemie, Weinheim. 2. Aufl.
- Bornscheuer, U.; Kazlauskas, R. J.; 1999;** Hydrolases in Organic Synthesis, Wiley-VCH.
- Chmiel, H. (Ed.); 1991;** Bioprozeßtechnik 1 & 2, Gustav Fischer Verlag, Stuttgart und neuere Auflage.
- Collins, A. N.; Sheldrake, G. N.; Crosby, J. (Eds.); 1992;** Chirality in Industry; John Wiley & Sons, Chichester.
- Cornils, B.; Herrmann, W. A.; Schlögl, R.; Wong, C.-H.,** Catalysis from A to Z, Wiley-VCH, Weinheim, 2000 und neuere Ausgaben.
- Cornish-Bowden, A. 1995;** Fundamentals of enzyme kinetics. 2nd ed. Portland Press.
- Drauz, K.; Waldmann, H. (Eds.); 2002;** Handbook of Enzyme Catalysis in Organic Synthesis; VCH, Weinheim.
- Faber, K.; 2000;** Biotransformations in organic chemistry, 4th ed. Springer Verlag, Berlin.
- Fluka,** Spezialbroschüre Enzymes; Fluka, Buchs, CH.
- Godfrey, T.; West, S. (Eds.); 1996,** Industrial Enzymology - Application of Enzymes in Industry; 2nd Edition, Macmillan, London.
- Holland, H. L.; 1992;** Organic synthesis with oxidative enzymes; VCH Weinheim.
- Karlson, P.; 1984;** Kurzes Lehrbuch der Biochemie; Georg Thieme Verlag, Stuttgart.
- Liese, A.; Seelbach, K.; Wandrey, C.,** Industrial Biotransformations, VCH-Wiley, Weinheim, 2000, 2004.
- Patel, R. N.,** Stereoselective Biocatalysis, Marcel Dekker, New York, 2000.
- Roberts, S. M.; Casy, G.; Nielsen, M.-B.; Phythian, S.; Todd, C., Wiggins, K.; 1999;** Biocatalysts for fine chemicals synthesis, John Wiley & Sons; previously published as Preparative biotransformations: Whole cells and isolated enzymes in organic chemistry. Wiley, Chichester, 1997.
- Schmid, R. D. 2001,** Taschenatlas der Bio- und Gentechnologie, Wiley-VCH. (Engl. Version 2003)
- Schomburg, D.; 1993;** Enzyme Handbook. Springer, Berlin; www.brenda.uni-koeln.de
- Segel, I. H.; 1975;** Enzyme kinetics. John Wiley & Sons, New York.
- Sheldon, R. A.; 1993;** Chirotechnology: industrial synthesis of optically active compounds; Marcel Dekker, New York.
- A. J. J. Straathof, P. Adlercreutz (Eds.), 2000:** Applied Biocatalysis, 2nd. Edition, Harwood Academic Publishers, Amsterdam, ISBN 90-5823-023-6
- Tanaka, A.; Tosa, T.; Kobayashi, T. (Eds.); 1993;** Industrial application of immobilized biocatalysts; Marcel Dekker, New York.
- Wong, C.-H.; Whitesides, G. M. 1994;** Enzymes in synthetic organic chemistry. Pergamon Press, Oxford.
- Selected Chapters/Keywords in (print, online)
- Roempp's Chemie Lexikon**
- Ullmann's Encyclopedia of Industrial Chemistry**
- Winnacker-Küchler** Winnacker-Küchler: Chemische Technik 5. Aufl. pp 1377-1416 (2005)
- Handbok of Heterogenous Catalysis, 2. Aufl. (2008).**