



A Renewed Look at Sustainable Energy: the Solar Strategy

Anjane'yulu' Krothapalli
Sustainable Energy Science & Engineering Center
Florida State University

COBEM 2005

November 7, 2005

Ouro Preto, Brazil



Objective

Present a synthesis of science and technologies related to
generation of electricity
and
fuel for transportation
in

A Sustainable Energy Supply Scenario



Energy and Sustainability

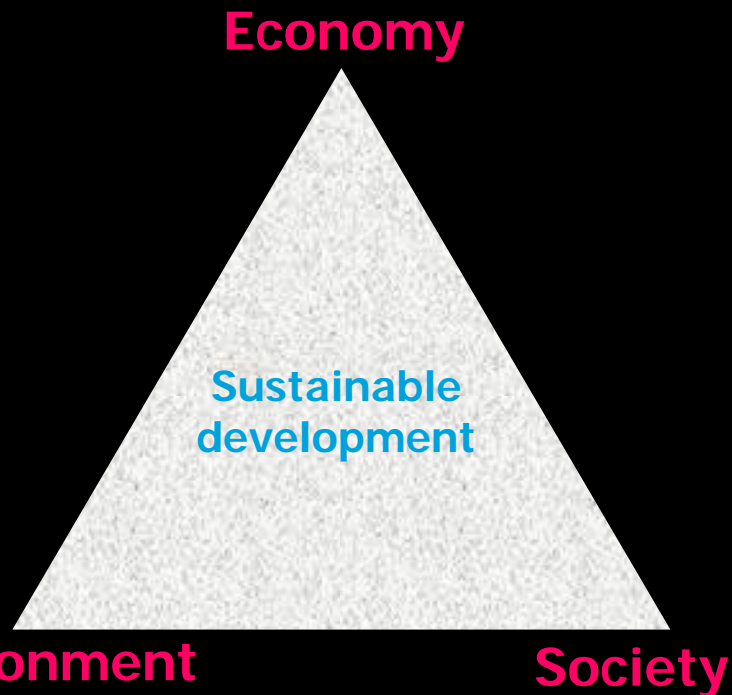

Economy: Per capita gross domestic product (GDP/population) and energy consumption per GDP (E/GDP)

Environment: The state of environment is greatly influenced by energy production methods. A measure of it can be the amount of green house gases, especially the CO₂ emitted per BTU (CO₂/E)

Society: Energy supply scenarios need to achieve a sense of social cohesion, cultural inclusion and people empowerment. The UN has defined a Human Development Index (HDI) which takes into account of indicators such as health, education and economic status. A strong correlation exists between HDI and energy use.

Challenge: *To fuel worldwide economic growth with secure and reliable energy supply without despoiling our environment and giving people the chance in shaping change for a preferable future.*



World Population

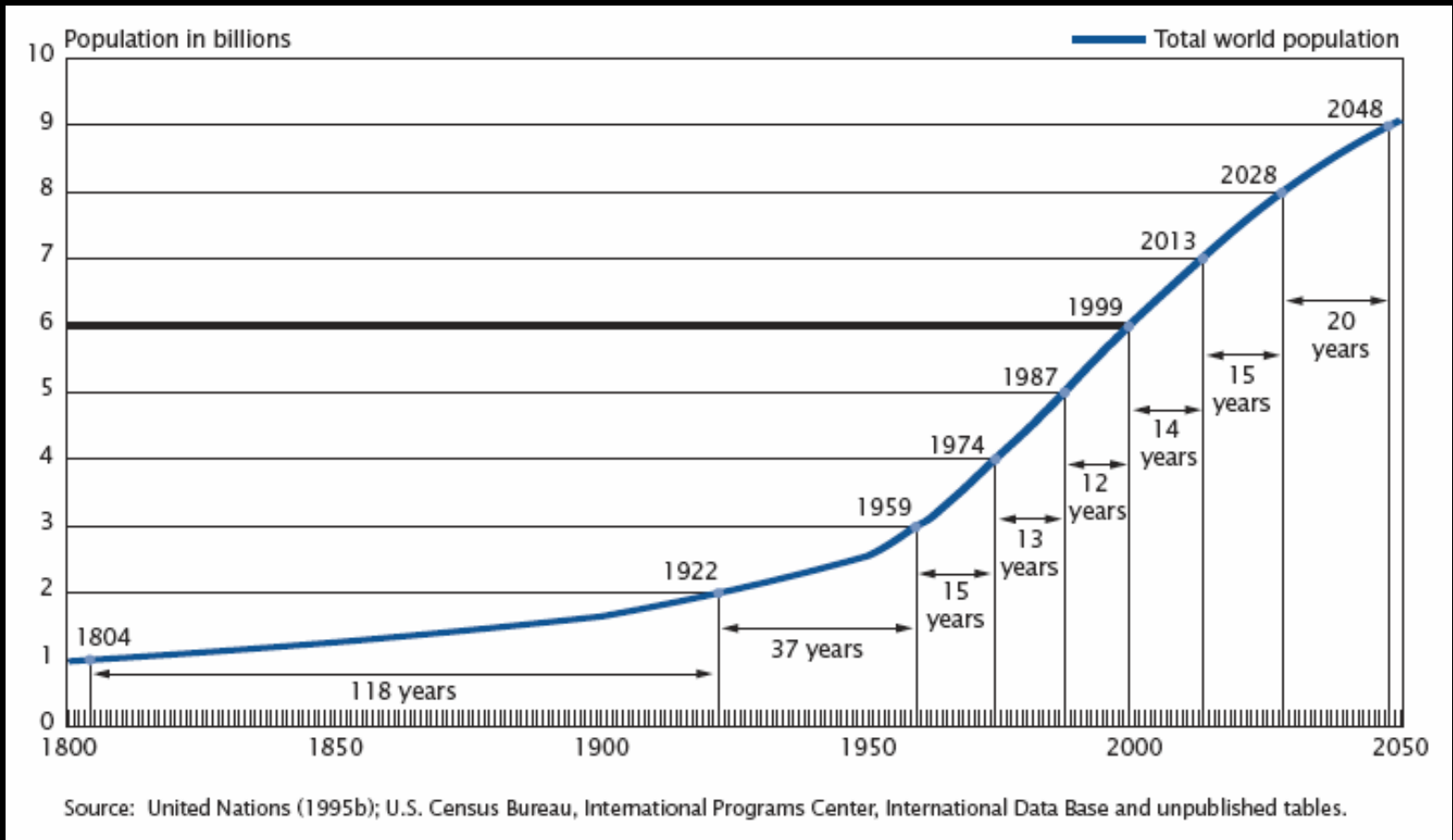

Good News: Growth rate is declining



Top Ten GDP Countries

Table 1. Top ten GDP's in 2004

Ranking	Economy	US dollars in millions
1	United States	11,667,515
2	Japan	4,623,398
3	Germany	2,714,418
4	United Kingdom	2,140,898
5	France	2,002,582
6	Italy	1,672,302
7	China	1,649,329
8	Spain	991,442
9	Canada	979,764
10	India	691,876

Table 2. Top ten GDP's in terms of PPP in 2004⁸

Ranking	Economy	US dollars in trillion	GDP per capita in US \$
1	United States	11.75	40,100
2	China	7.62	5,600
3	Japan	3.75	29,400
4	India	3.32	3,100
5	Germany	2.36	28,700
6	United Kingdom	1.78	29,600
7	France	1.74	28,700
8	Italy	1.61	27,700
9	Brazil	1.49	8,100
10	Russia	1.40	9,800

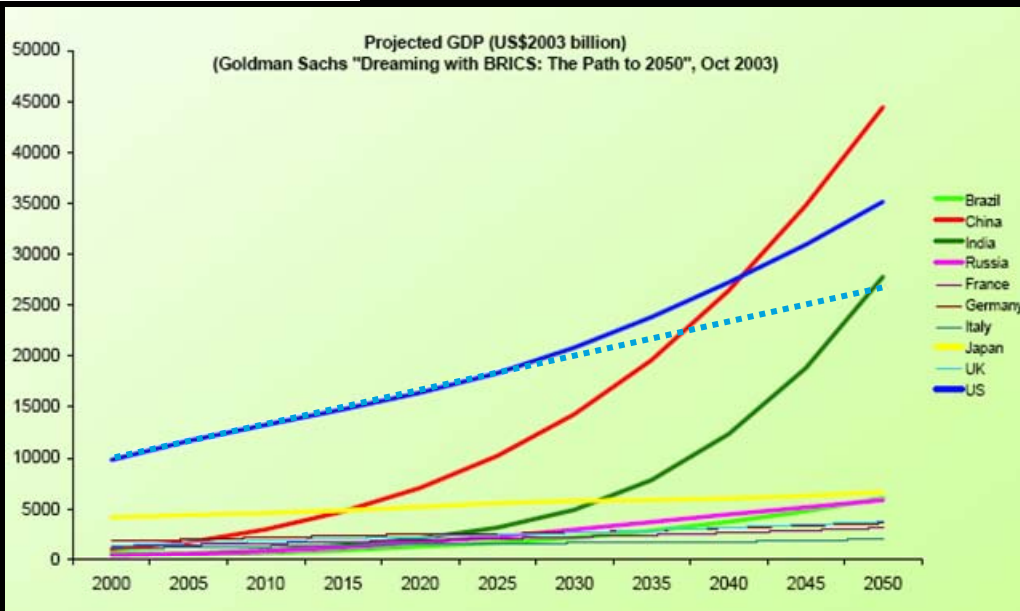



People Purchasing Power

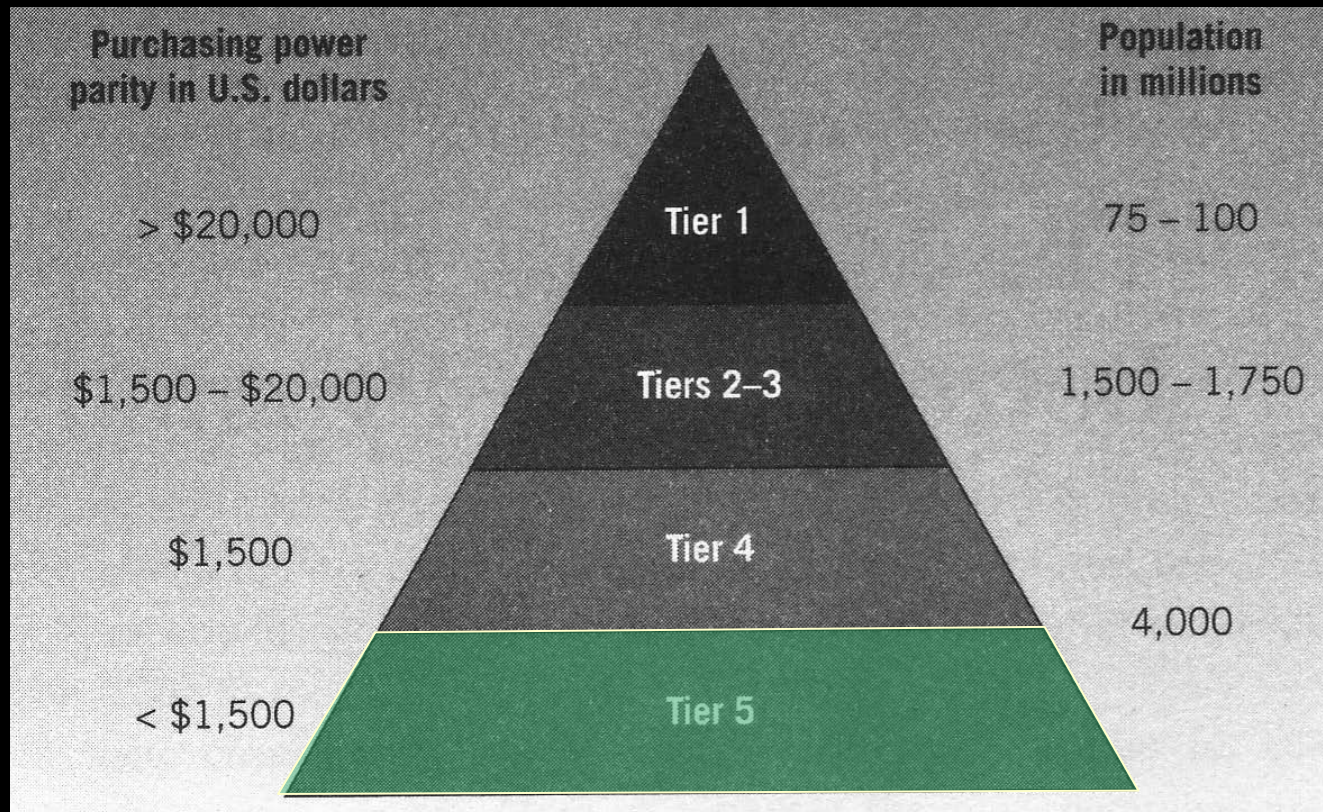

Challenge: Energy supply to people in Tier 5 with innovations at affordability level



Per Capita Energy Consumption and GDP

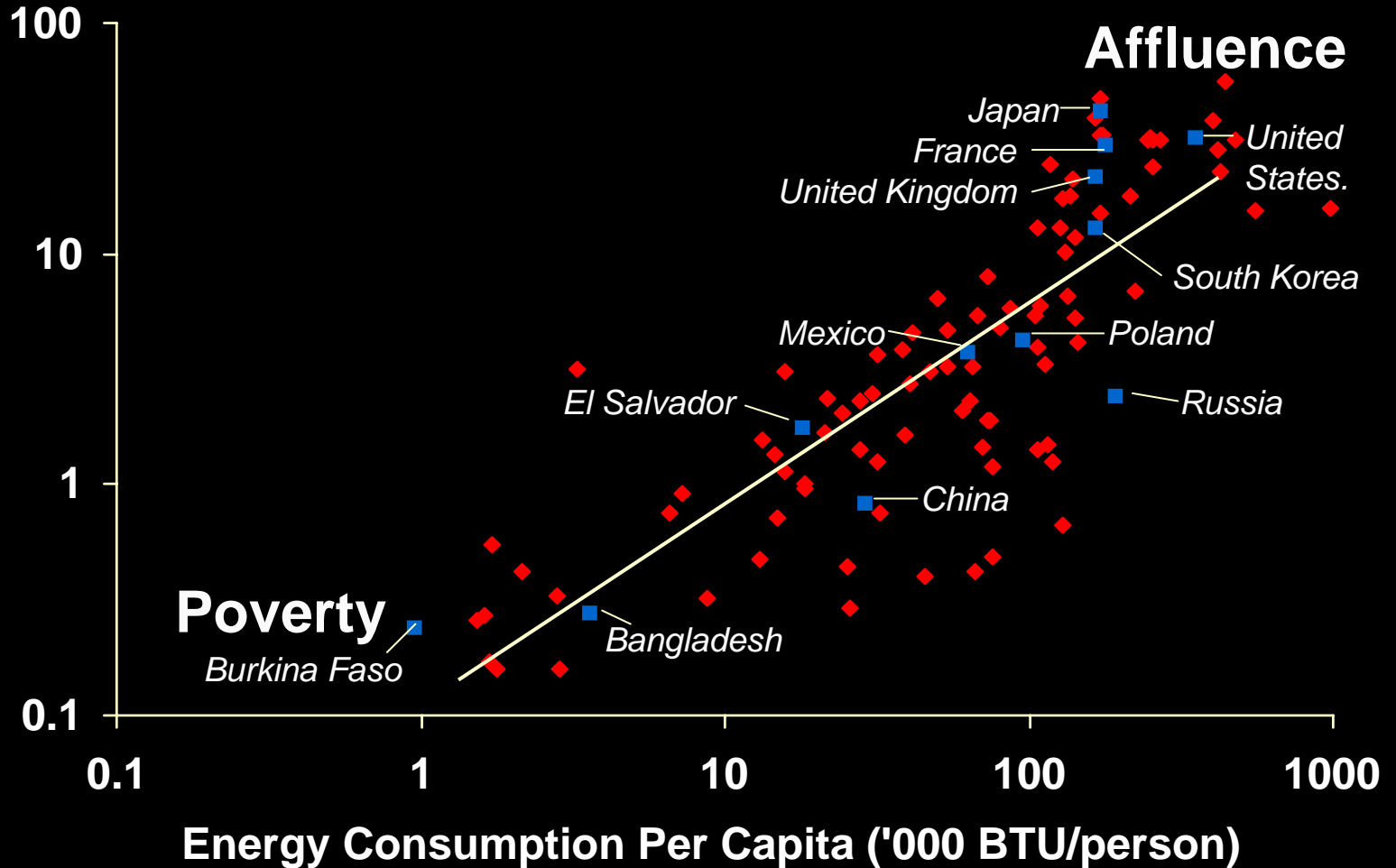



Car Driving and Per Capita GDP

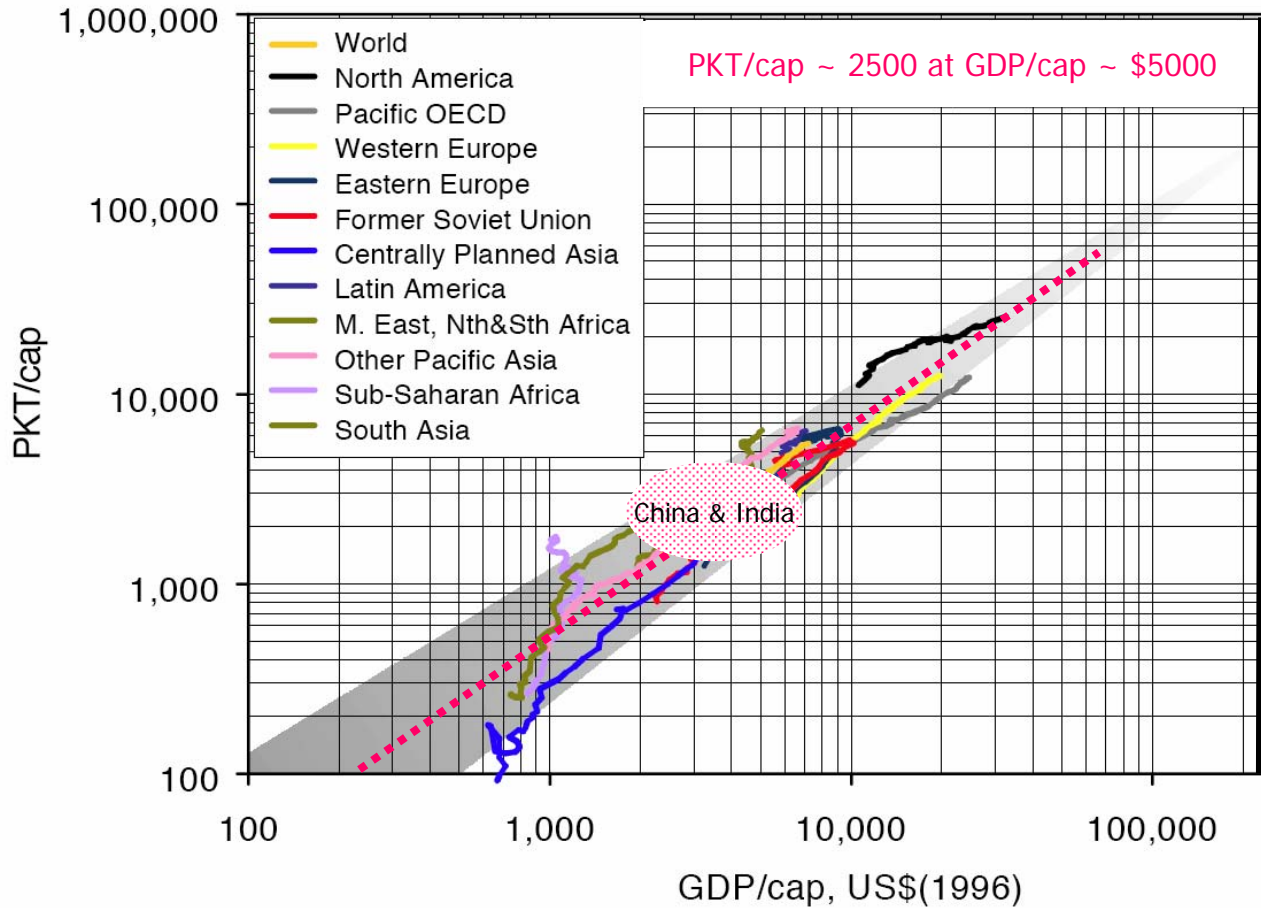

PKT/cap: passenger km traveled per capita



Per Capita Energy Consumption and HDI

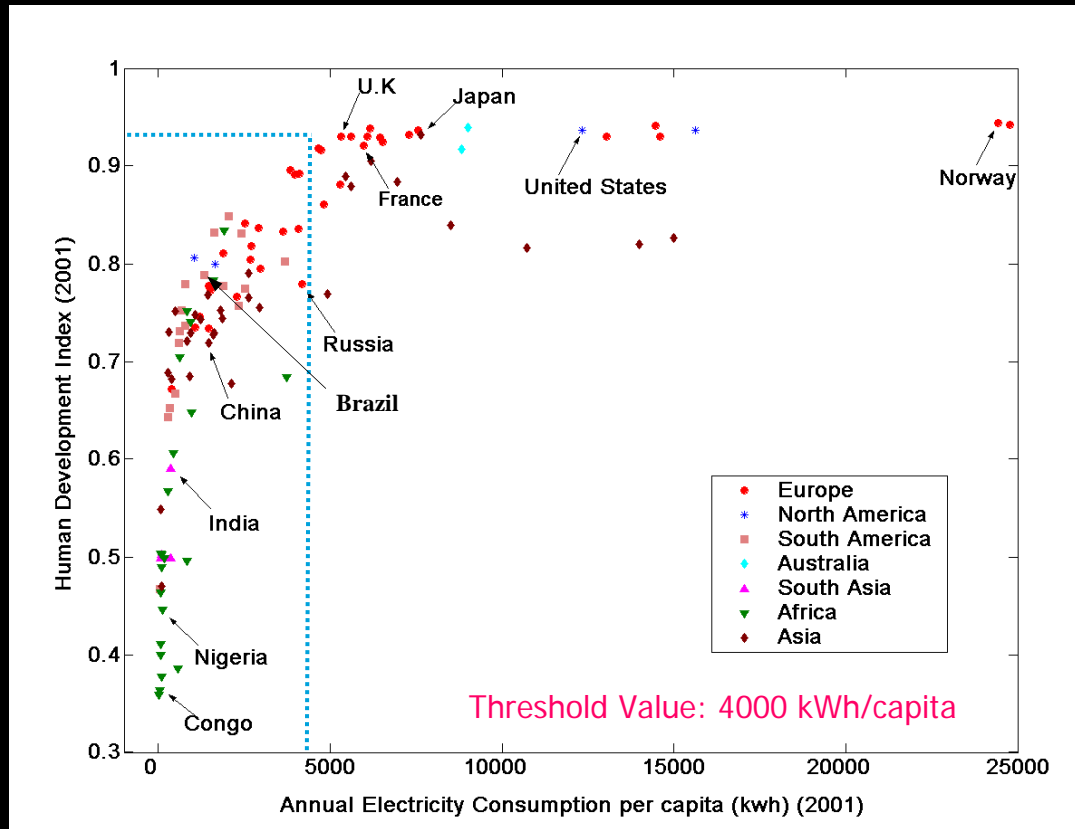

HDI: Human development index - a composite measure of development based indicators: life expectancy, educational level and per capita gross domestic product. Each data point corresponds to a country. Modest increase in PCEC can lead to marked improvements in the quality of life in the developing nations.



Global Annual Energy Use

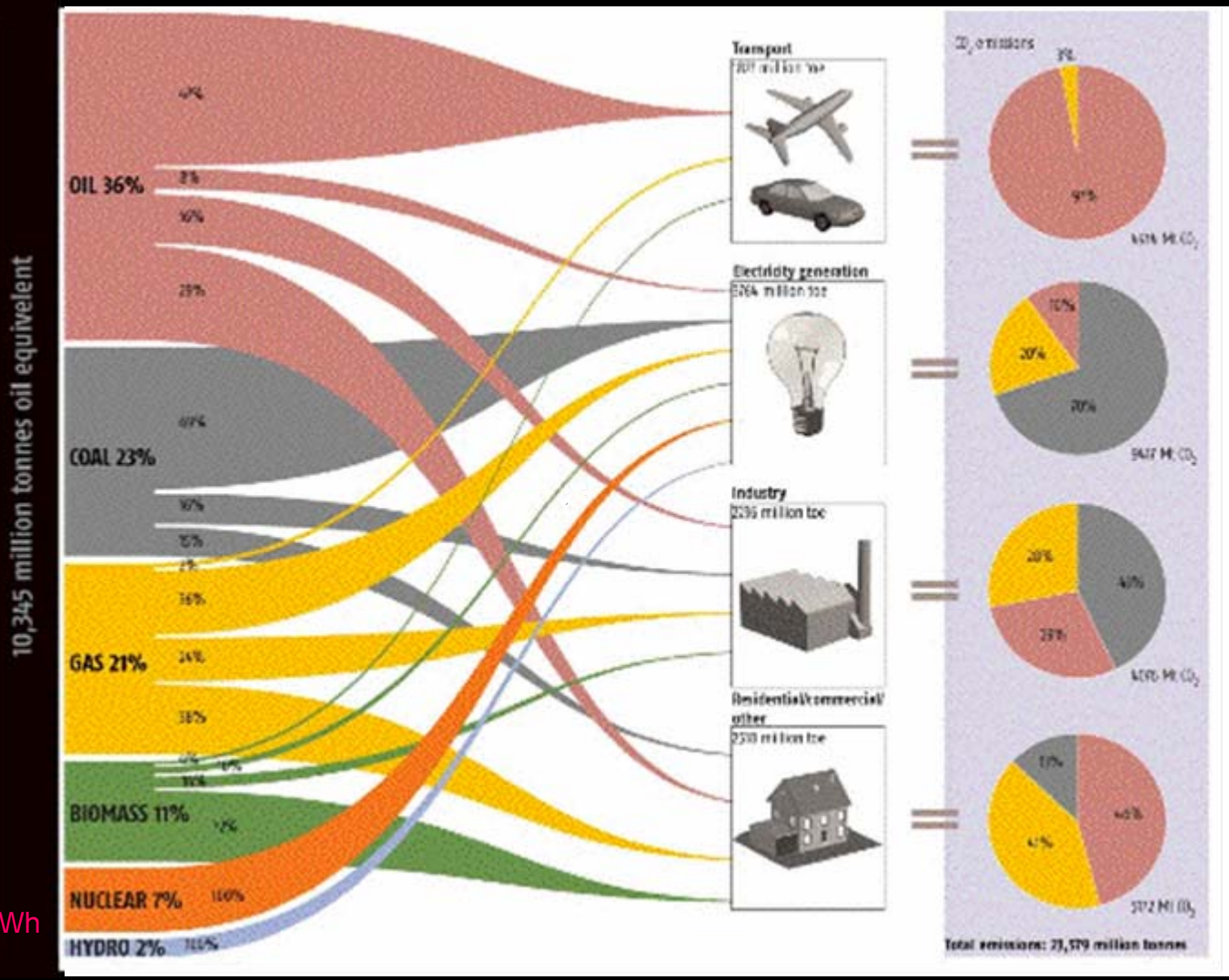

1 toe = 1.64 x 10⁴ kWh



Annual Energy Use

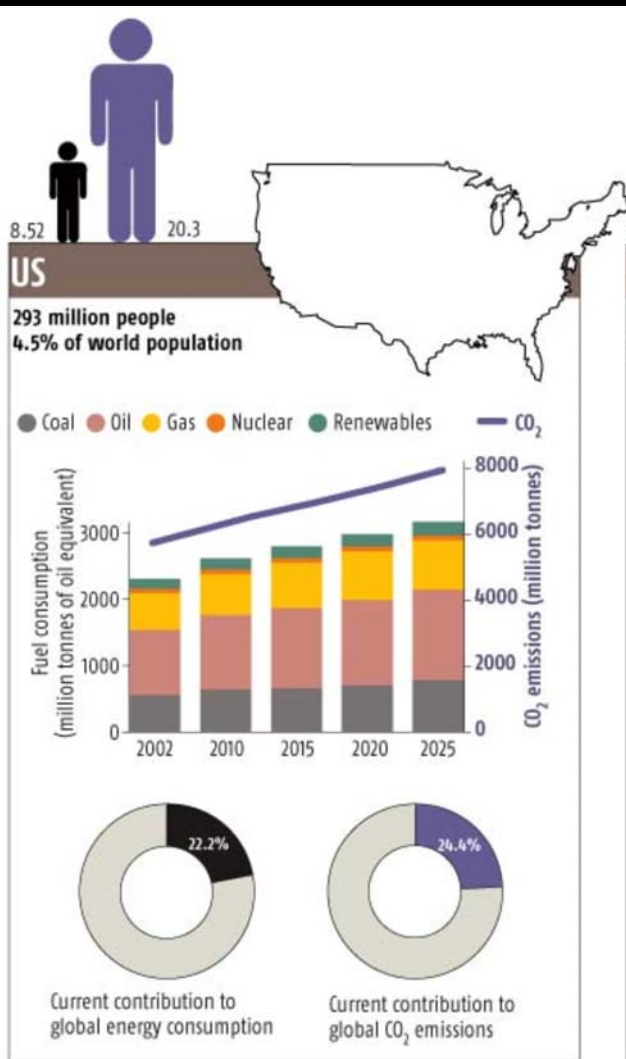

Per capita energy consumption, 2002 (tonnes of oil equivalent) Per capita CO₂ emissions (tonnes)

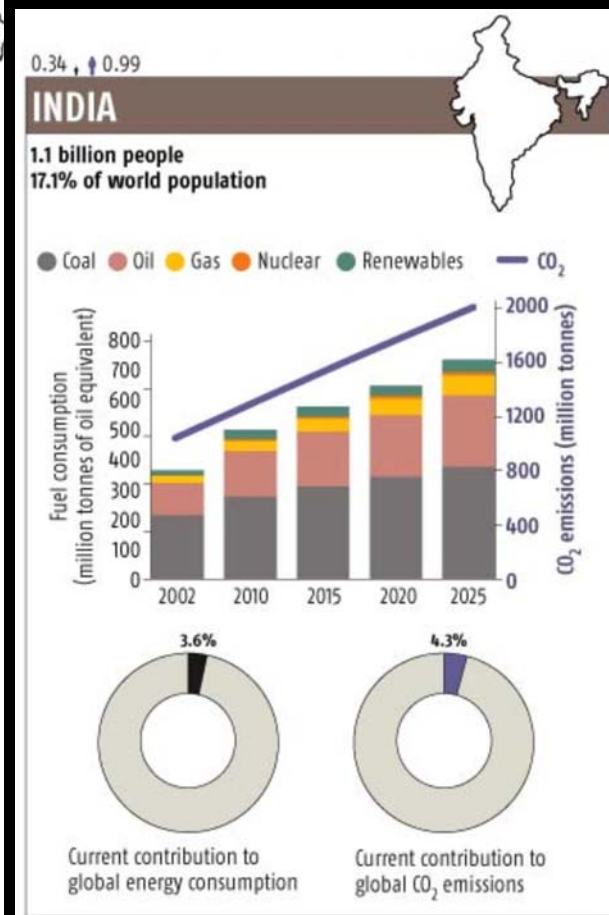
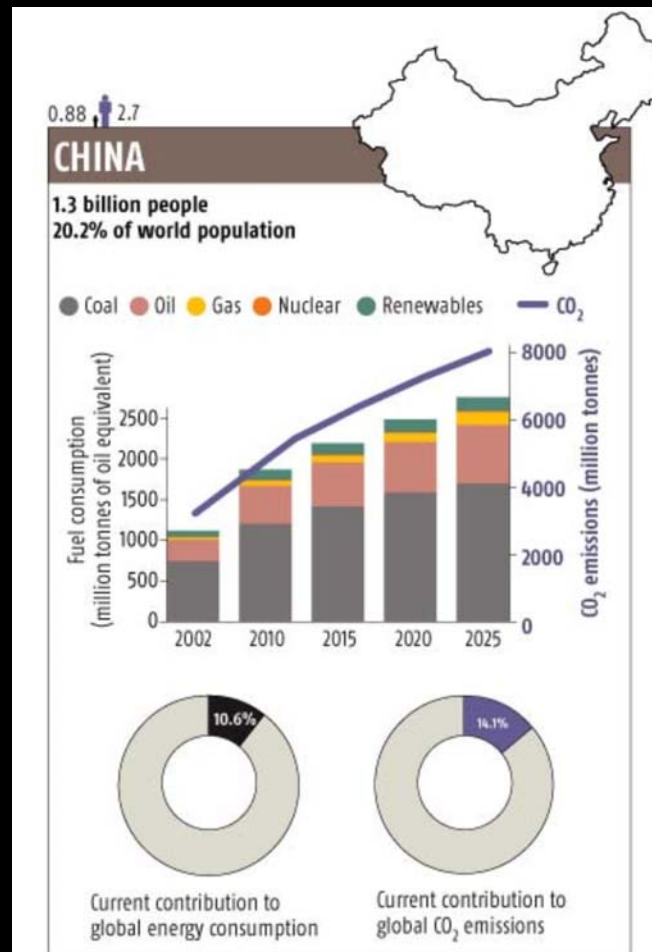



Demand for Oil in China

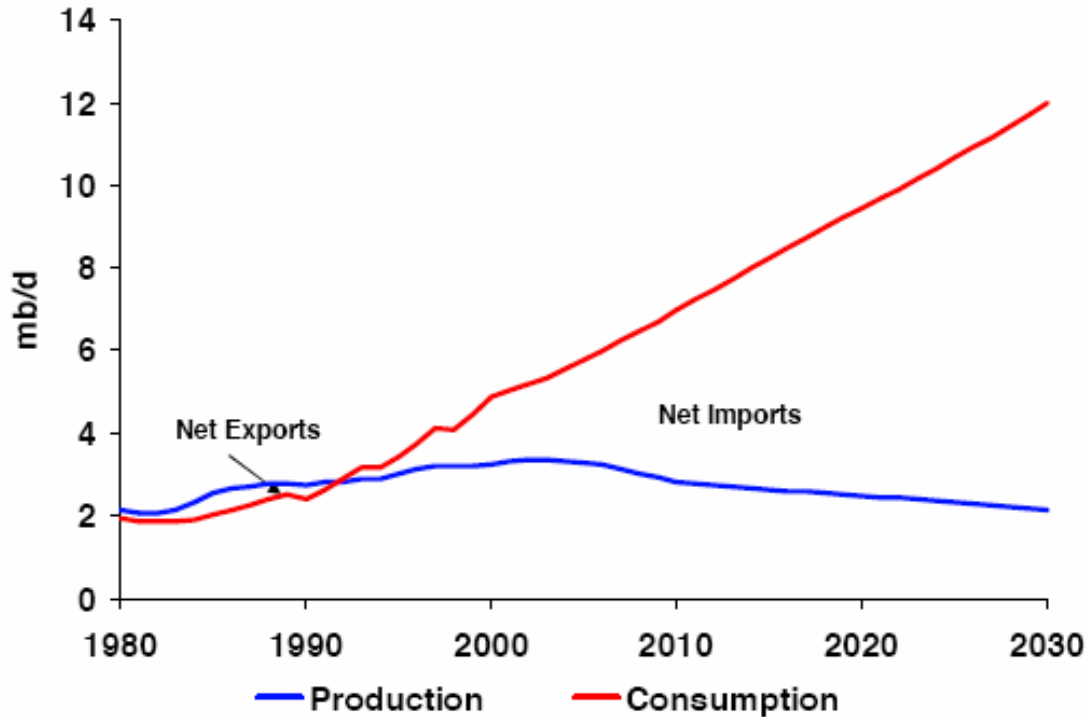

Rapid motorisation underpins strong oil demand growth. Net oil imports will rise from 1.7mb/d in 2001 to 9.8mb/d in 2030.

Oil imports will reach almost 10 mb/d in 2030, equivalent to US imports today.



US Annual Oil Production

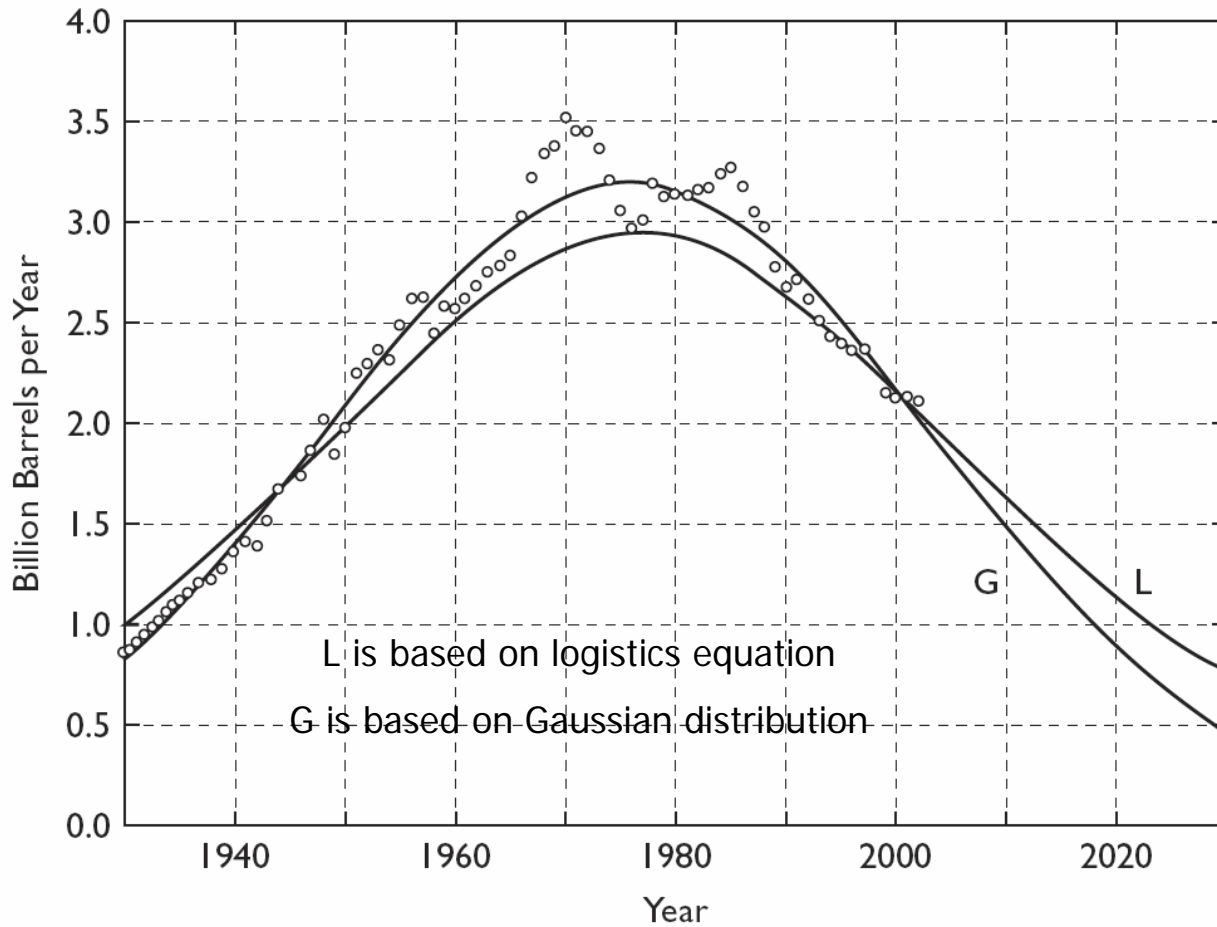



Annual World Oil Production

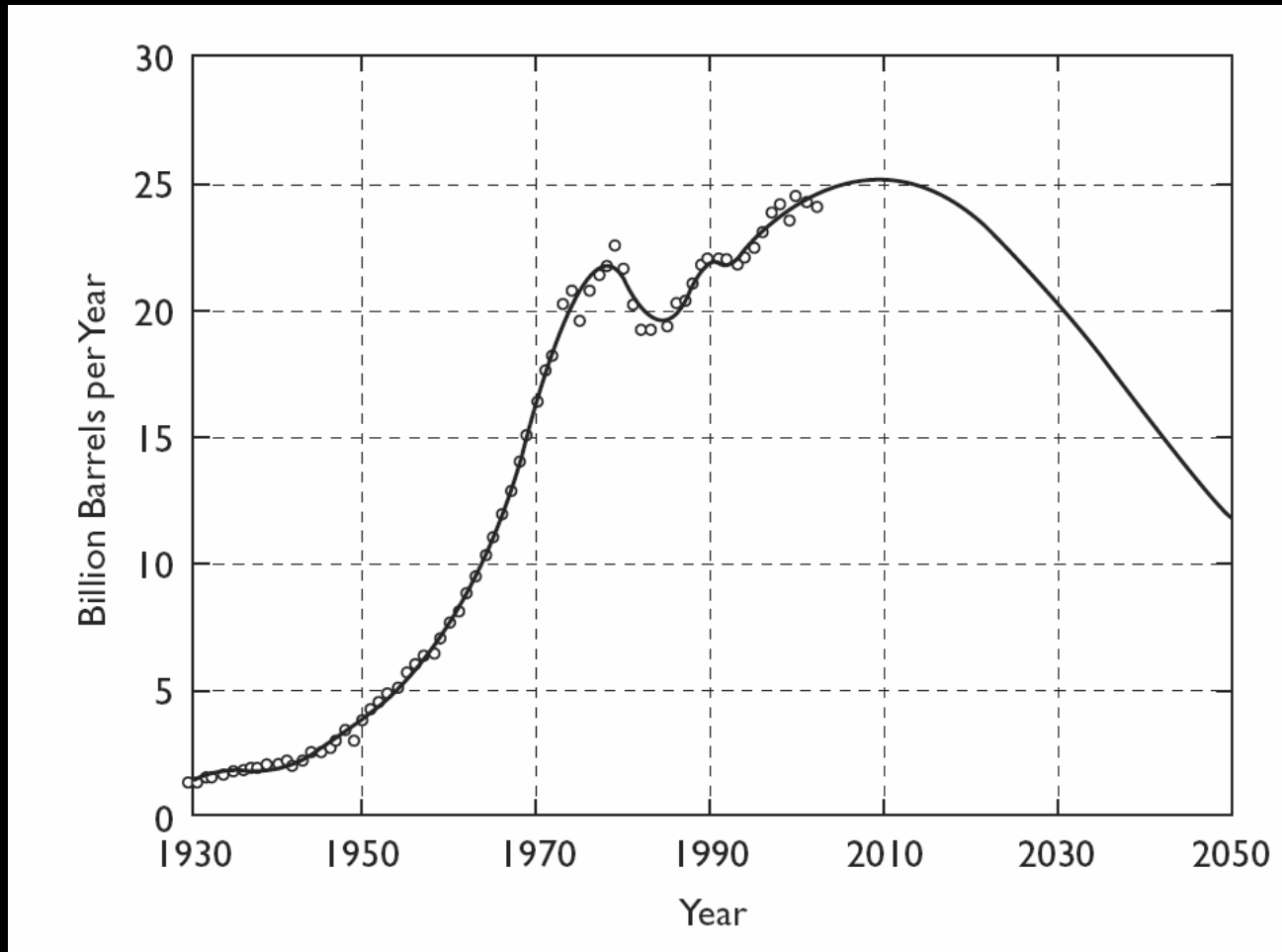



World Oil Prices

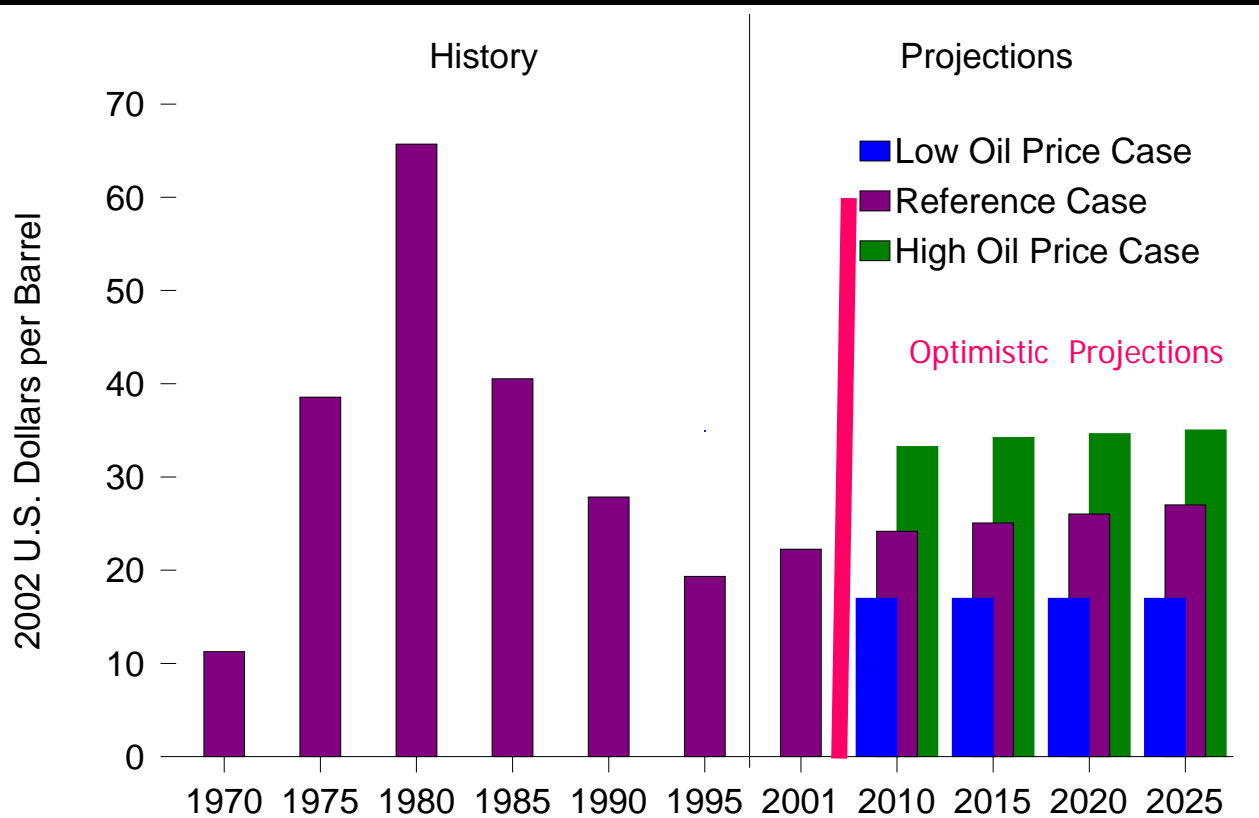

“International Energy Agency warned that if oil prices remained at \$35 a barrel, or \$10 above their 2001 levels, that would slash at least half a percentage point from world G.D.P. the next year”

NY times - August 11, 2004 - Global oil demand expected to exceed forecasts, Report says

\$60 a Barrel will reduce the world GDP by 1.75% from 2001 levels (~ \$785 Billion)



Fossil Fuel Future

Dwindling reserves versus worldwide growth in demand will lead to energy prices beyond consumer's ability to pay - leads to political tension and violence.

Conventional oil and gas reserves will probably be exhausted between 2040 and 2050.

Coal is the worst possible fossil fuel (most polluting of the fossil fuels and the one that produces the greatest amount of the greenhouse gas CO₂ per unit energy), but the world has at least a 150 year supply of coal.

“Within a few generations at most, some other energy than that of combustion of fuel must be relied upon to do a fair share of the work of the civilized world.”

Robert H. Thurston - 1901 in the Smithsonian Institution annual report.*

* Professor of Engineering at Cornell University



Major Global Climate Issues

- Global stratospheric ozone (O₃) Reduction
- Global warming

Climate Change

"Collapse of Mayan civilization is attributed to two centuries of dryness about 1100 years ago."

"About 5000 years ago a sudden drying converted the Sahara from a green landscape dotted with lakes to the scorching, sandy desert it is today." - Scientific American, November 2004.



Climate & Atmospheric History of the Past 420,000 years

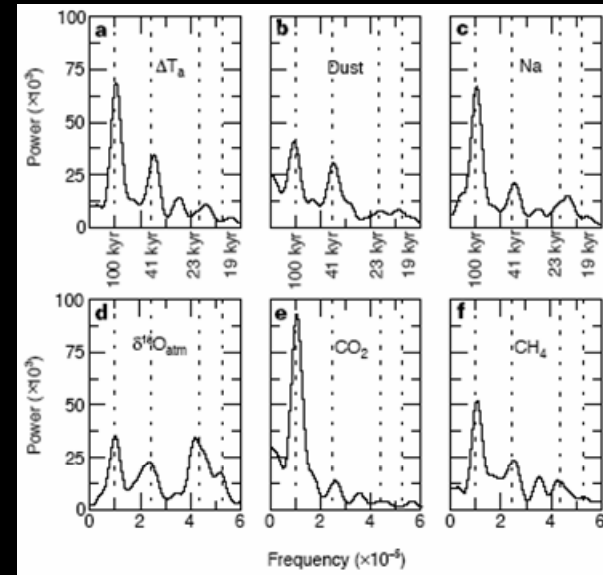
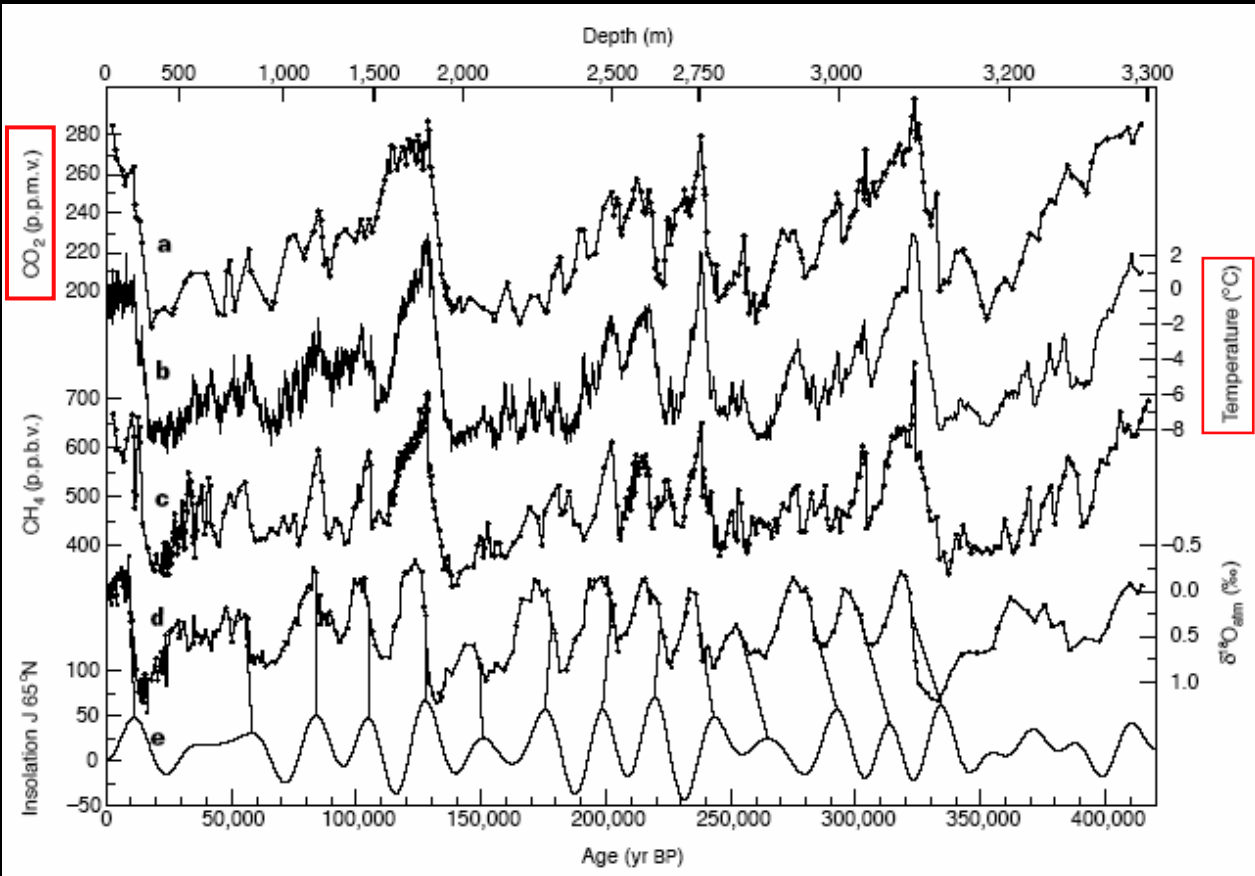

Spectral properties

Ref: Climate and atmospheric history of the past 420,000 years from the Vostok ice core, Antarctica, J.R. Petit et al, Nature, 399, 3, June 1999, 429 - 436.



Milankovitch cycles

Caused by gravitational attraction between planets of the solar system and Earth due to changes in the eccentricity of the Earth's orbit, obliquity of the Earth's axis and precession of the Earth's axis of rotation.

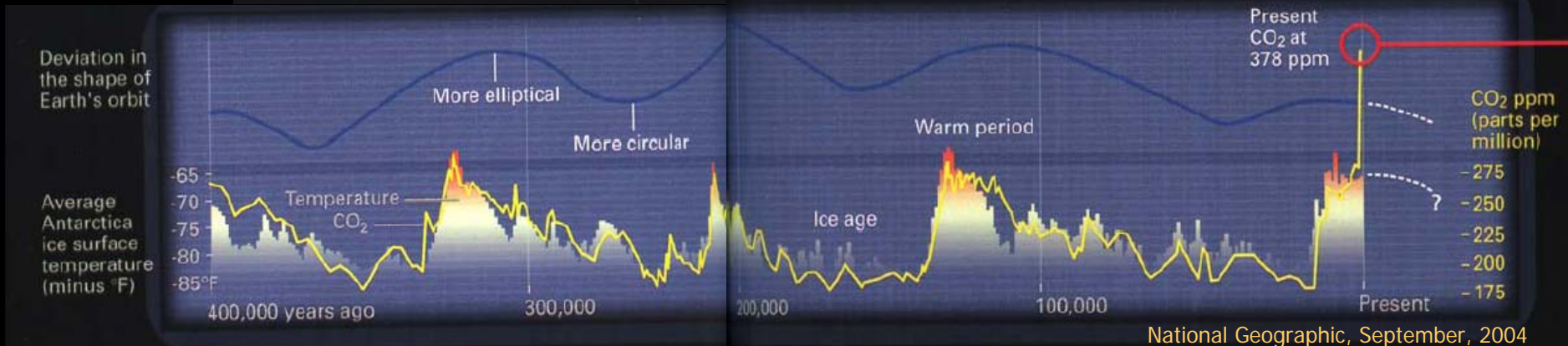
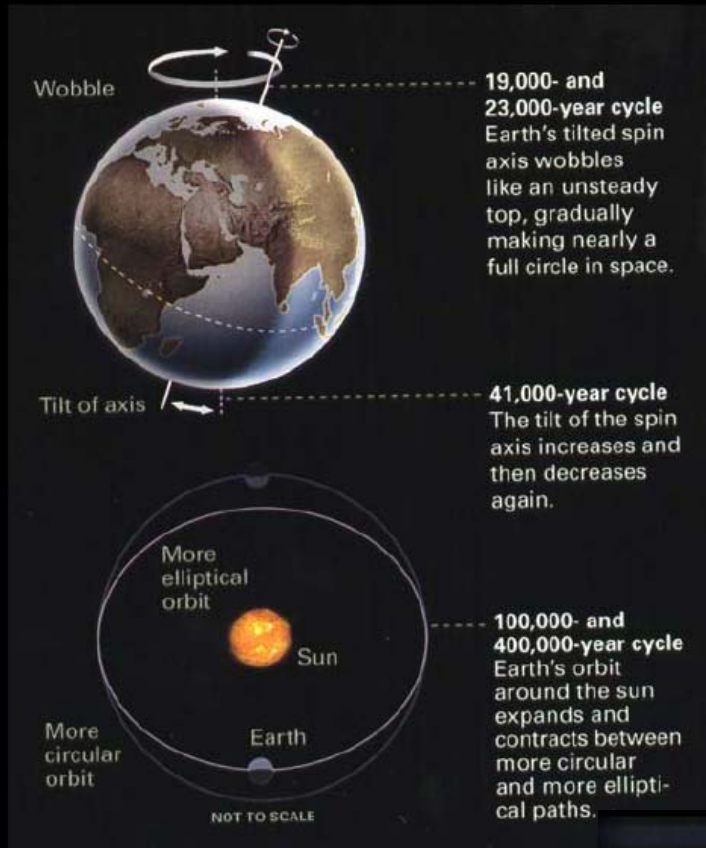



CO₂ Concentrations

Projected concentrations

Recent past concentrations

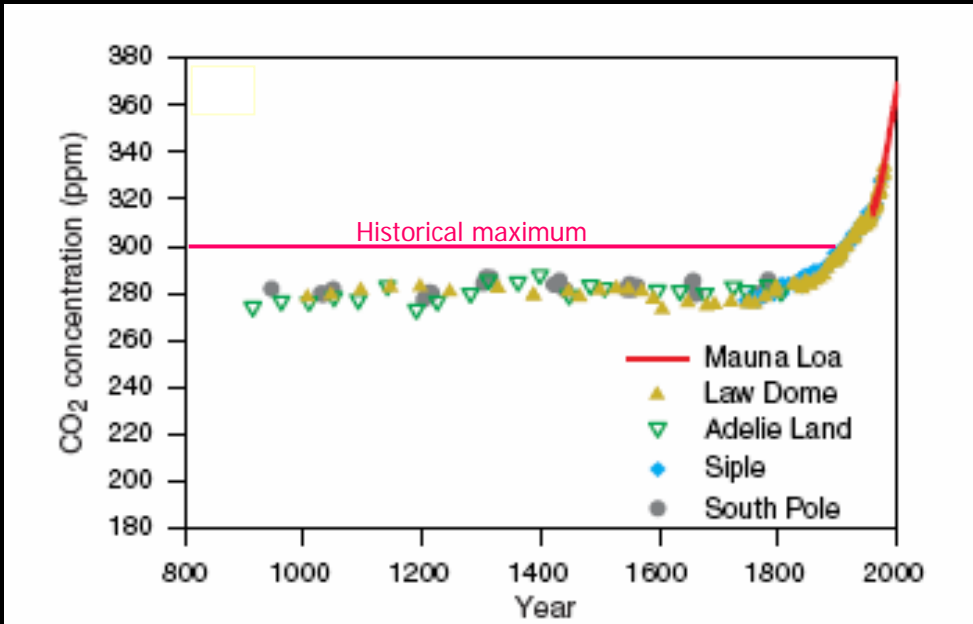

376 ppm in 2003

379 ppm in 2004

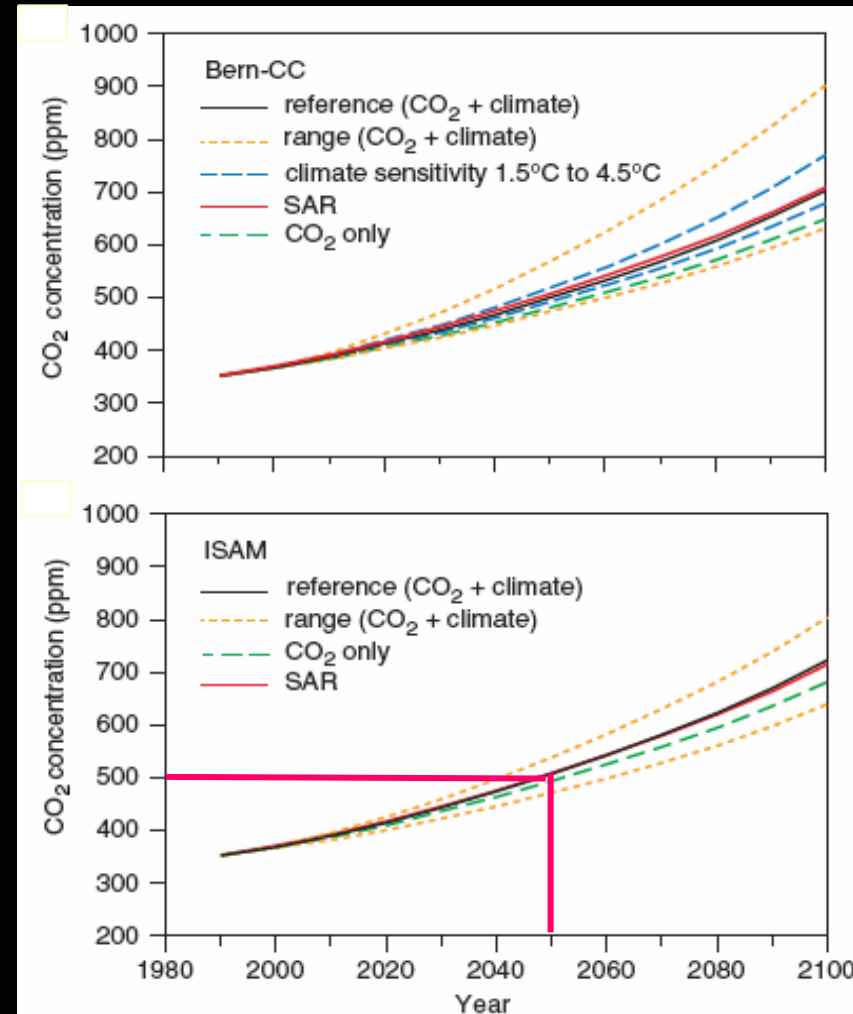



Global Temperature Change

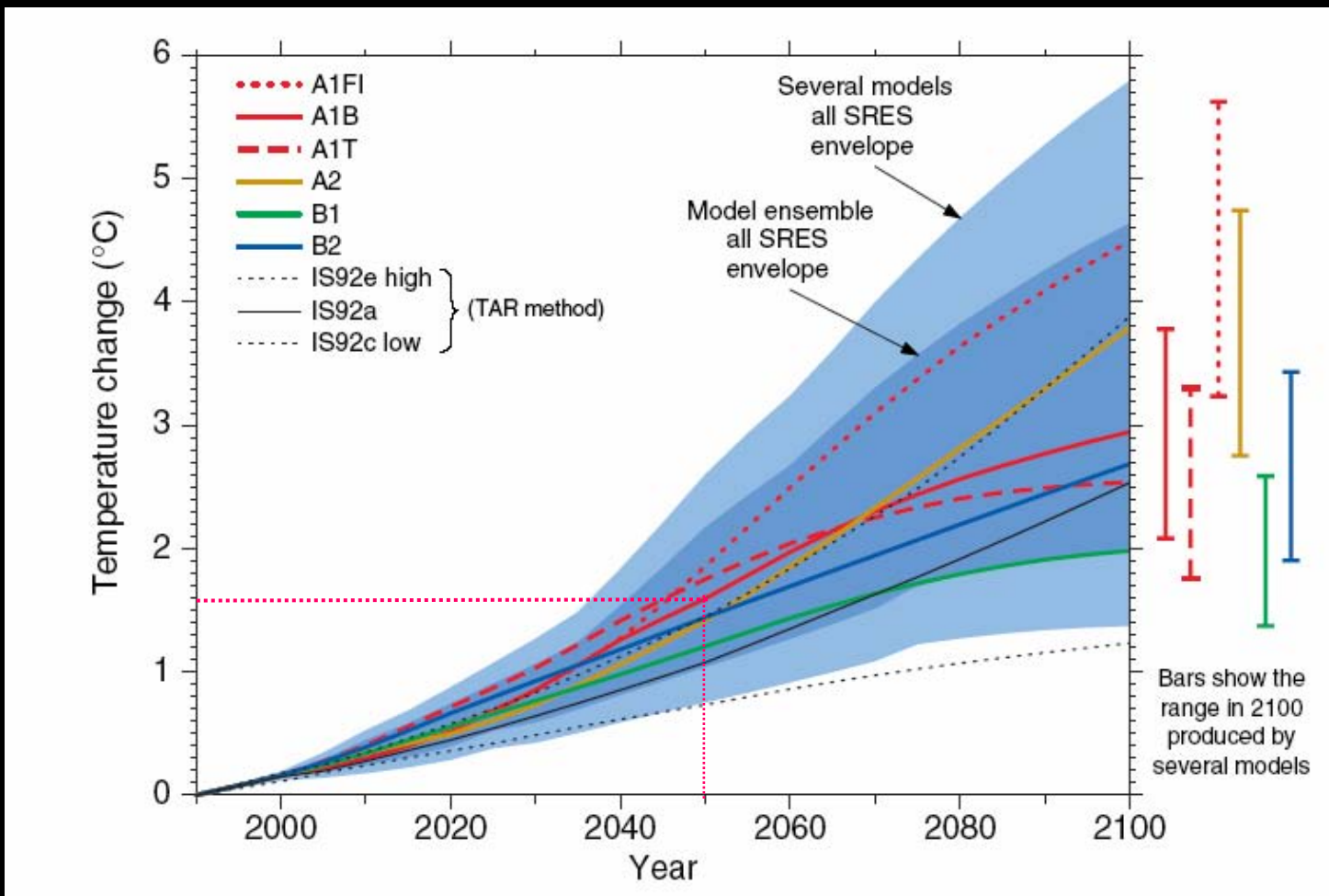



Arctic Ice Cap

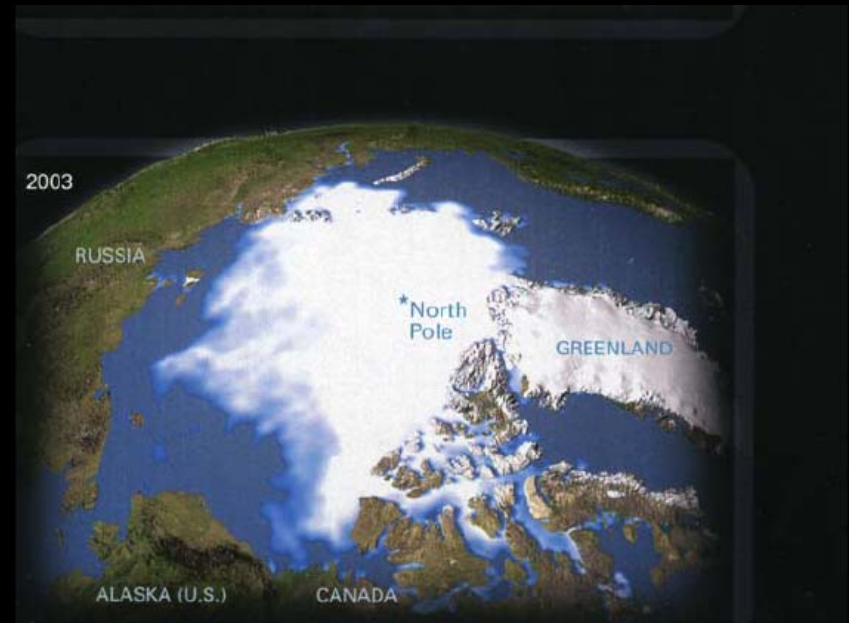
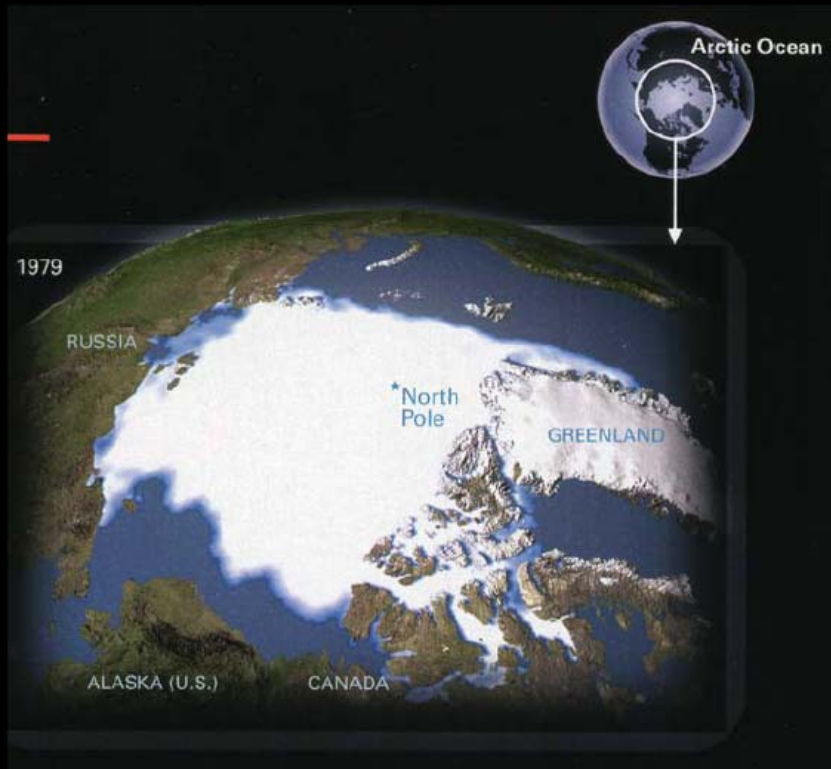

"Global warming should be more of worry than ever: it could be pushing the earth's climate closer to the thresholds that could unleash sudden changes faster"



China - Environment



Afternoon rush hour, cars clog Beijing's second ring road

Cyclists ride through the smog that hangs over Beijing's Tiananmen square



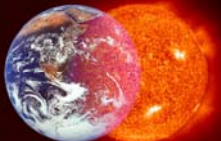

China - Environment



er Urumchi
g Uighur
region.

A c
th





China - Environment

400,000 people die prematurely every year in China from diseases linked to air pollution.

On certain days almost 25 percent of the particulate matter clotting the skies above Los Angeles can be traced to China.

China could eventually account for roughly a third of the California's air pollution.

China is wrestling with a lot of the same pollution problems that US wrestled with several years ago and that, to some extent, still grappling with today.

A law taking effect next year will require that China produce 10 percent of its energy from renewable sources by 2020.



Climate Change - View point

"We have sufficient evidence that human-made climate change is the most far-reaching and almost certainly the most threatening of all the environmental challenges facing us," Gordon Brown, Britain's finance minister

"We are still working on the issue of causation, the extent to which humans are a factor" in Global Warming - James L. Connaughton, chairman of the US Council on Environmental quality



US CO₂ Emissions in 2000

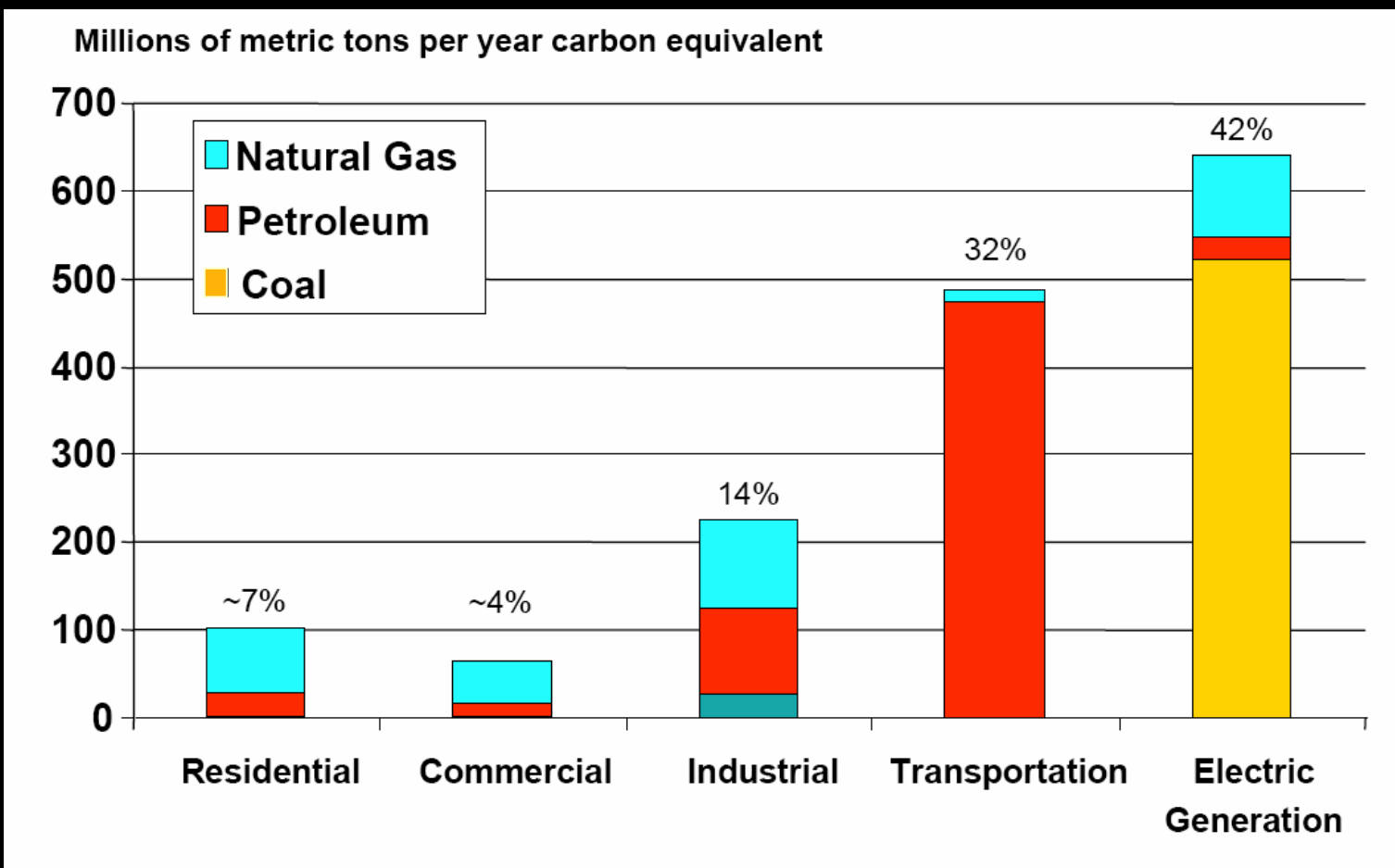



Sustainable Energy Vision

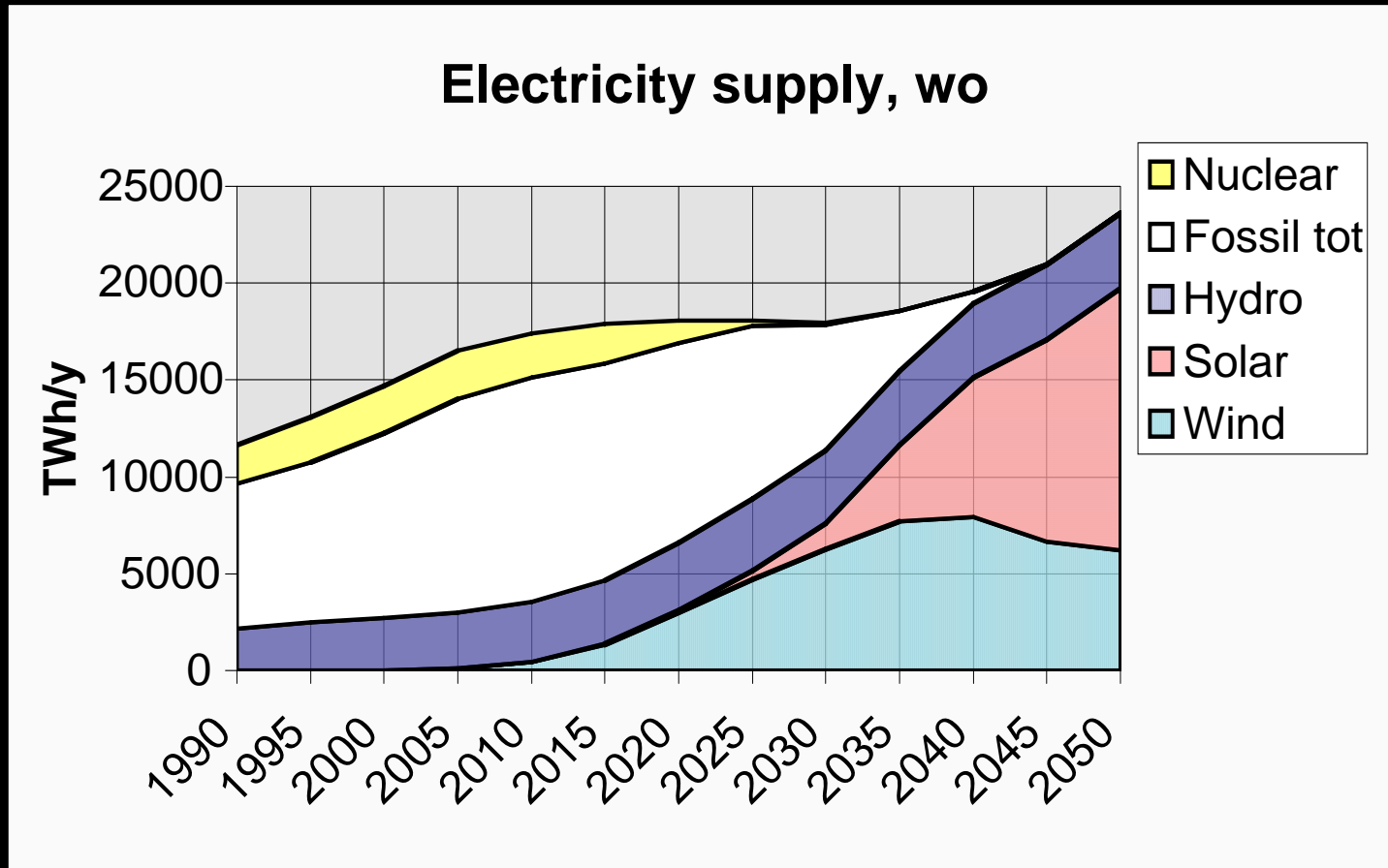



Distributed Power

Optimal generation plant size for a single plant based on cost per megawatt [MW], 1930-1990

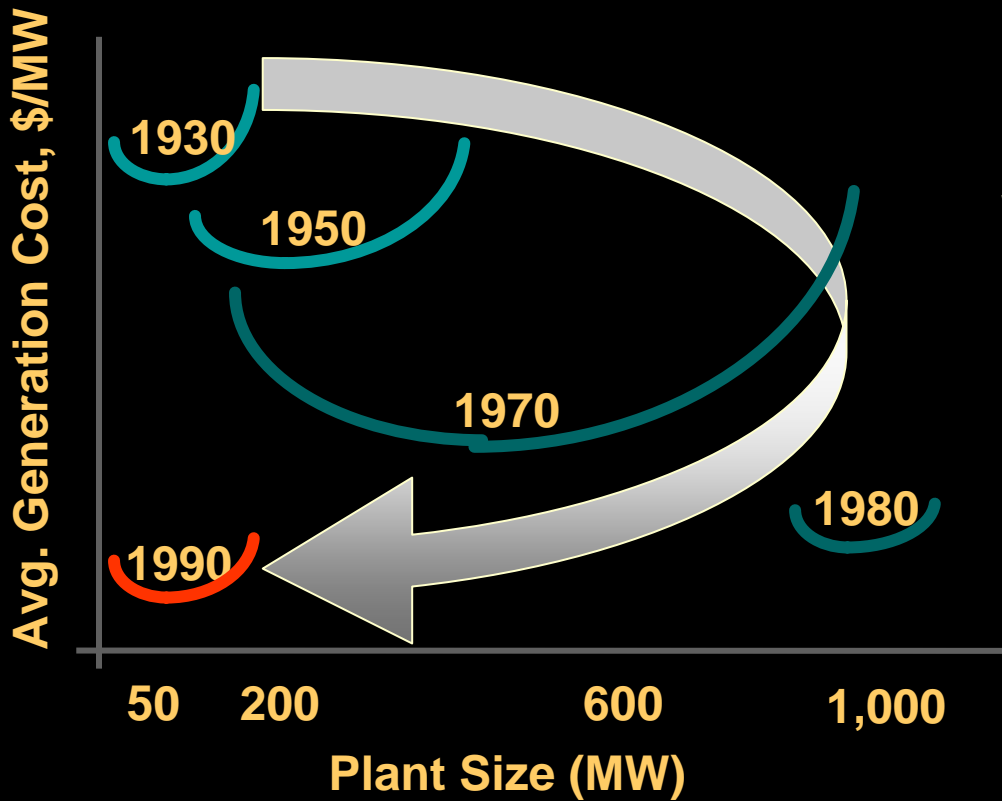

DG Market Worldwide (GW/Yr)

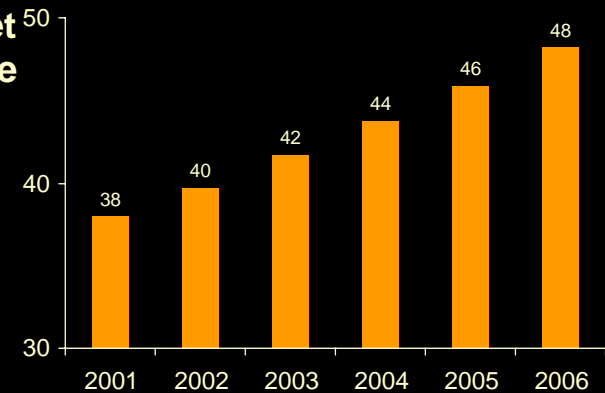



Wind Energy Potential

Globally: 27% of earth's land surface is class 3 (250-300 W/m² at 50 m) or greater

- potential of 50 TW

4% utilization of > class 3 land area will provide 2 TW

US: 6% of land suitable for wind energy development - 0.5 TW

US electricity consumption ~ 0.4 TW

Off shore installations provide additional resource

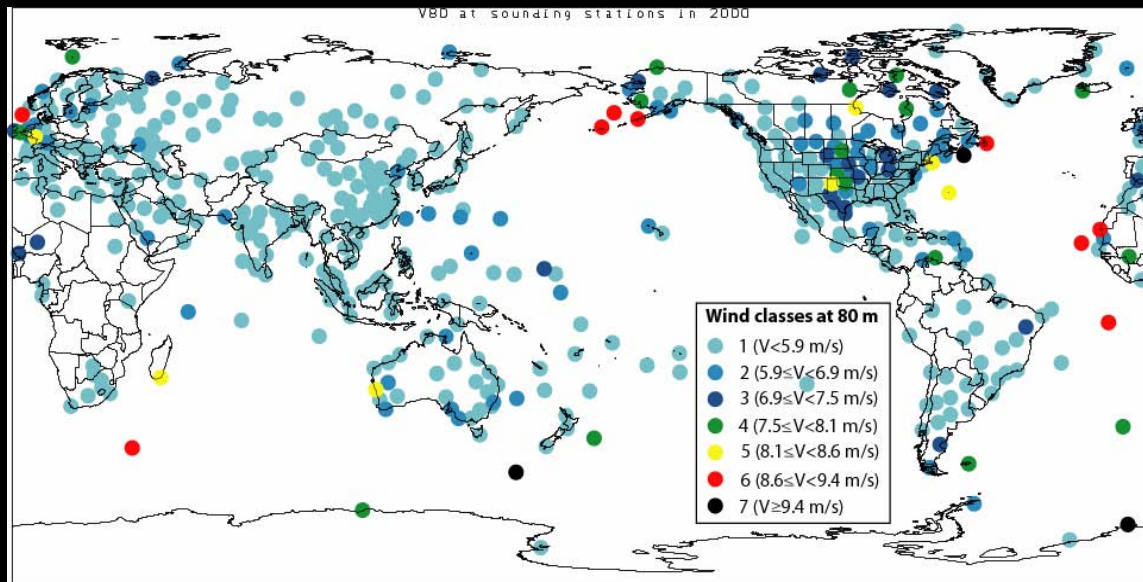



Enercon Offshore Prototype



Enercon 4.5MW 112 meter rotor



440 metric tonnes



Wind Energy Costs Trends

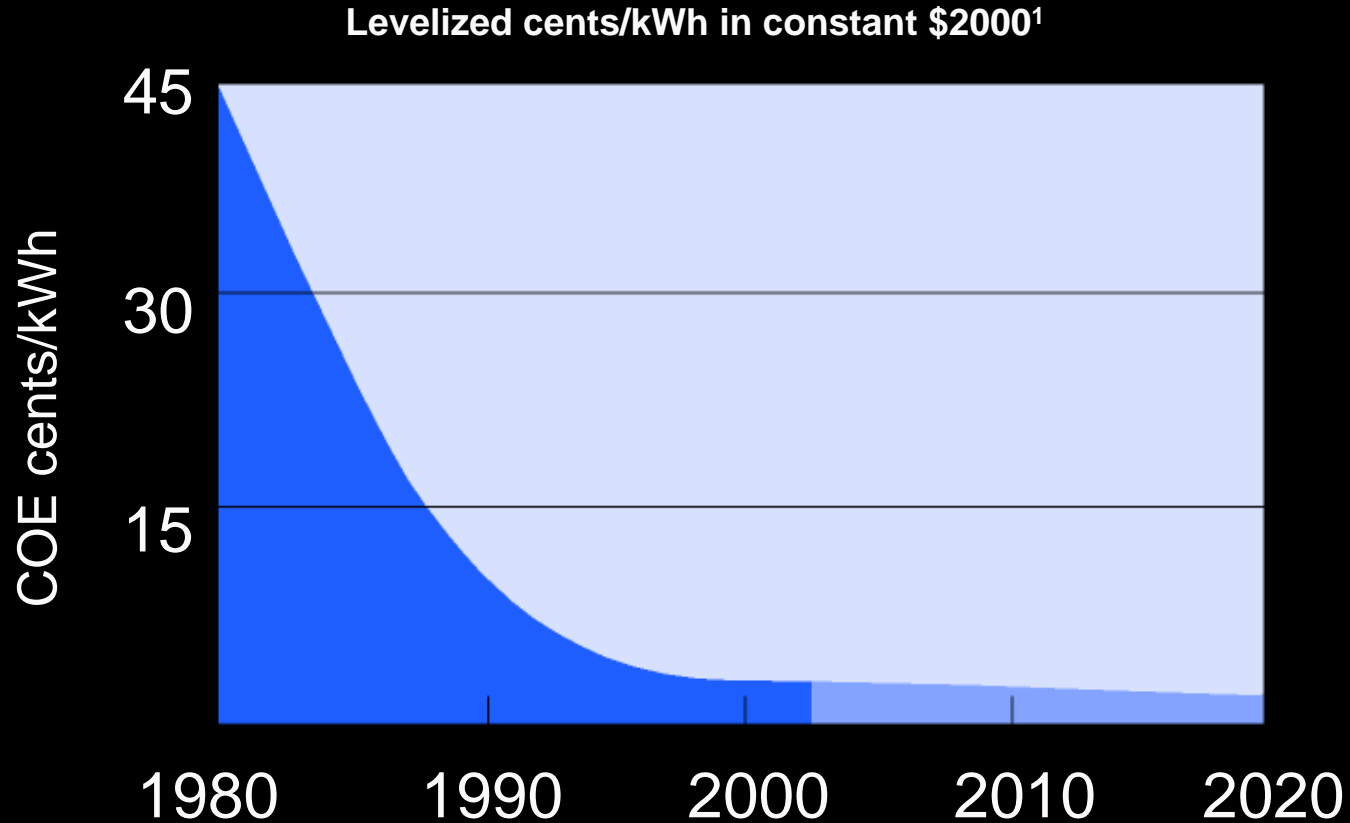

Source: NREL Energy Analysis Office

¹These graphs are reflections of historical cost trends NOT precise annual historical data.

Updated: June 2002



Global Wind Energy Growth

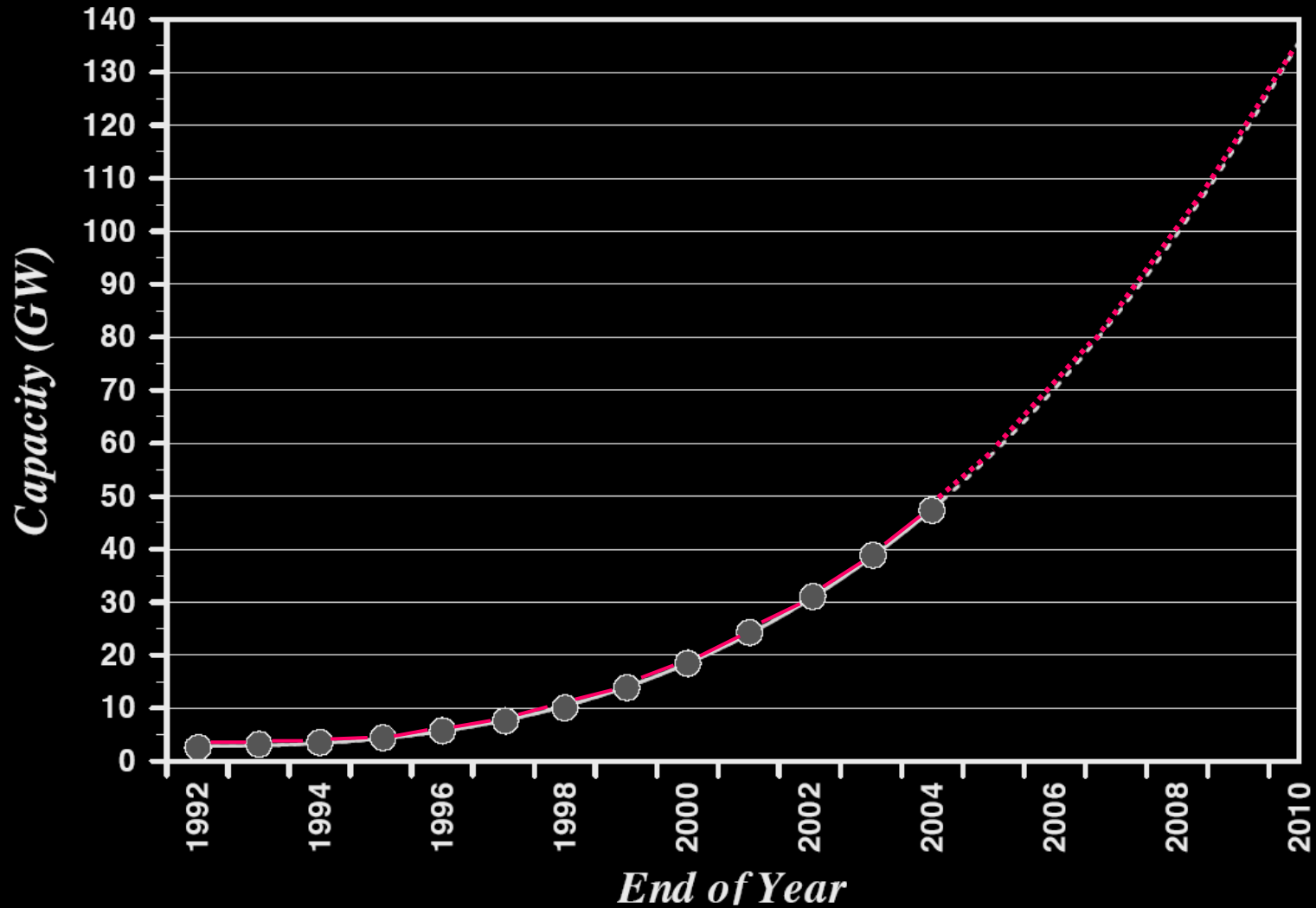

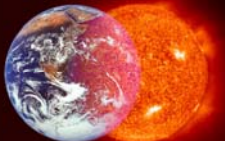

Global Wind Energy

Country	2004 MW	% of total
Germany	16,629	35.1
Spain	8,263	17.5
United States	6,740	14.2
Denmark	3,117	6.6
India	3,000	6.3
Italy	1,125	2.4
Netherlands	1,078	2.3
United Kingdom	888	1.9
Japan	874	1.8
China	764	1.6

World Total: 47,317 MW

2004 Installations: 7,976 MW

Growth rate: 20%

2020 Prediction: 1,245,000 MW*

Equivalent to 1000 Nuclear power plants

12% of world electricity generation

* According to Wind Force 12



Solar Energy Potential

Theoretical: 1.76×10^5 TW striking Earth; 0.3 Global mean albedo

Practical: 600 TW

Conversion Efficiency: 10%

Electricity generation potential = 60 TW

Estimated Global Demand in 2050 = 20 TW



Solar Cell Land Area Required

6 Boxes at 3.3 TW Each = 20 TW



Solar Electricity

Solar-thermally generated electricity: Lowest cost solar electric source.

Complex collectors to gather solar radiation to produce temperatures high enough to drive steam turbines to produce electric power.

For example, a turbine fed from parabolic trough collectors might take steam at 750 K and eject heat into atmosphere at 300 K will have a ideal thermal (Carnot) efficiency of about 60%. Realistic overall conversion (system) efficiency of about 35% is feasible.

Solar Photovoltaic energy:

The direct conversion of sun's rays to electricity.

The efficiency (the ratio of the maximum power output and the incident radiation flux) of the best single-junction silicon solar cells has now reached 24% in laboratory test conditions. The best silicon commercially available PV modules have an efficiency of over 19%.



Parabolic-Trough Technology

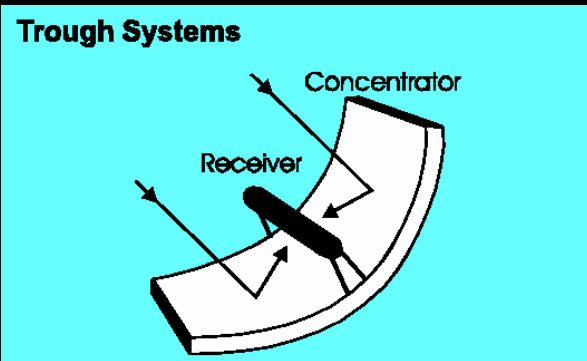

Parabolic trough-shaped mirrors to focus sunlight on thermally efficient receiver tubes that contain a heat transfer fluid.

Fluid Temperature: 665 K

Nine trough systems, built in 1980's are currently generating 354 MW in southern California



Solar Dish-engine

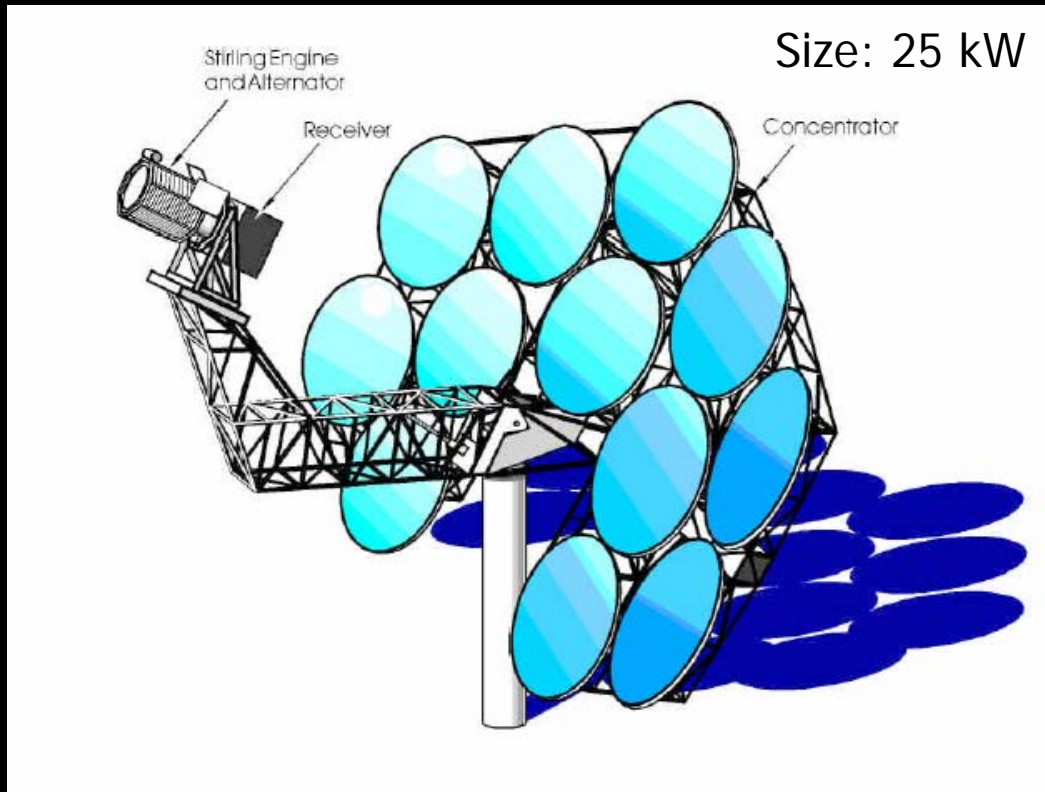

Stirling energy systems signed a 20 year power purchasing agreement with Southern California Edison to provide 500 MW power using 20,000 dishes (11.3m in diameter) in the Mojave Desert. The project occupies 18 km² of land area. The solar generator efficiency peaks at 29.4%.

Power costs are expected to be significantly less than US peak rate of 11.33 cents/kWh



Advanced Tower

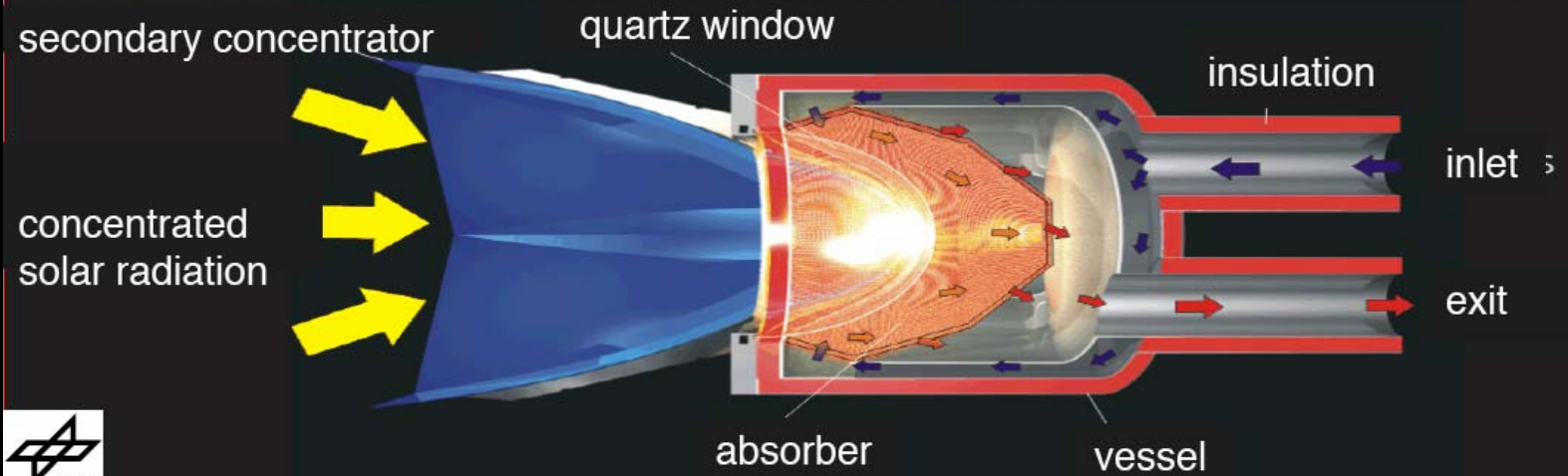
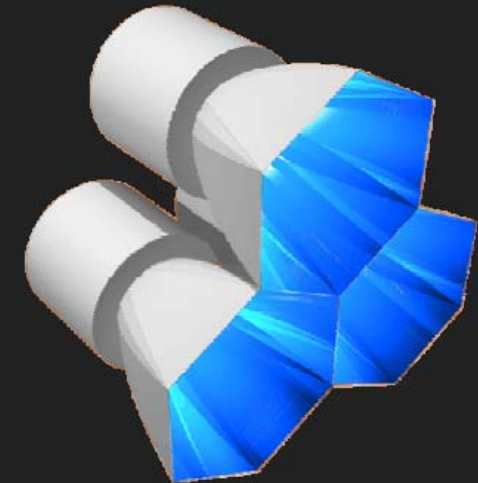



System Efficiency

$$\eta_{\text{system}} = \eta_{\text{collector}} * \eta_{\text{process}}$$

Collector Efficiency x Carnot Efficiency
vs. Concentration Ratio

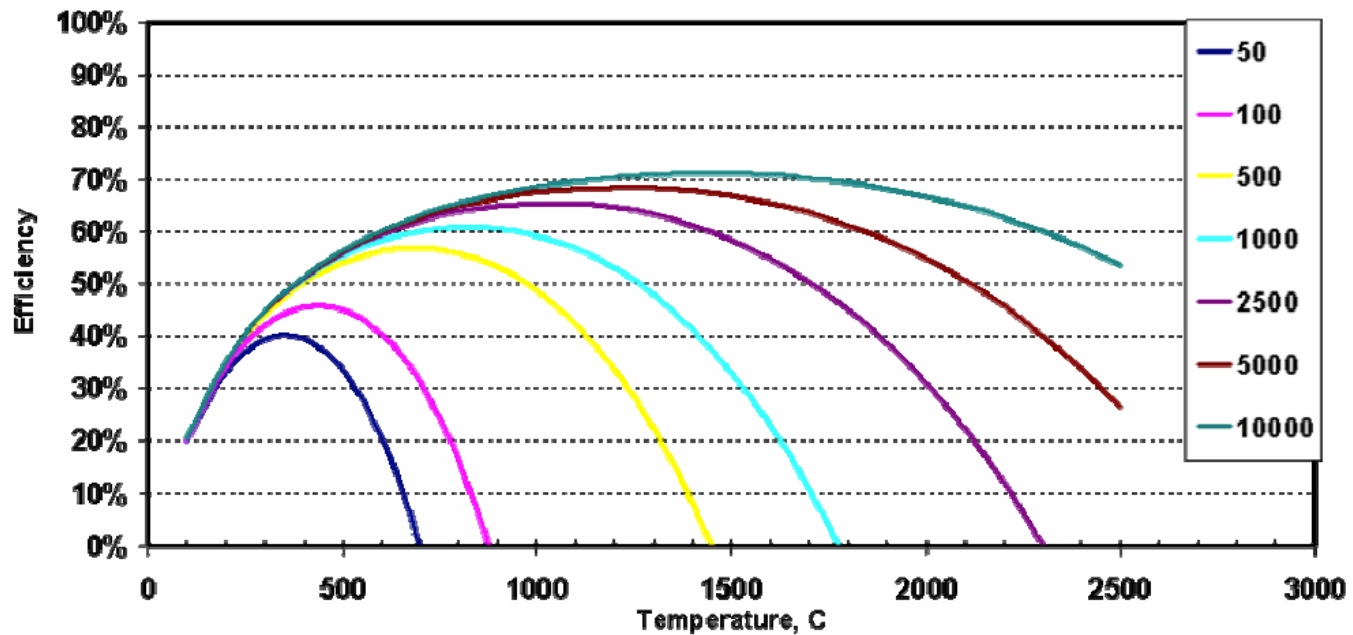



Solar Thermal

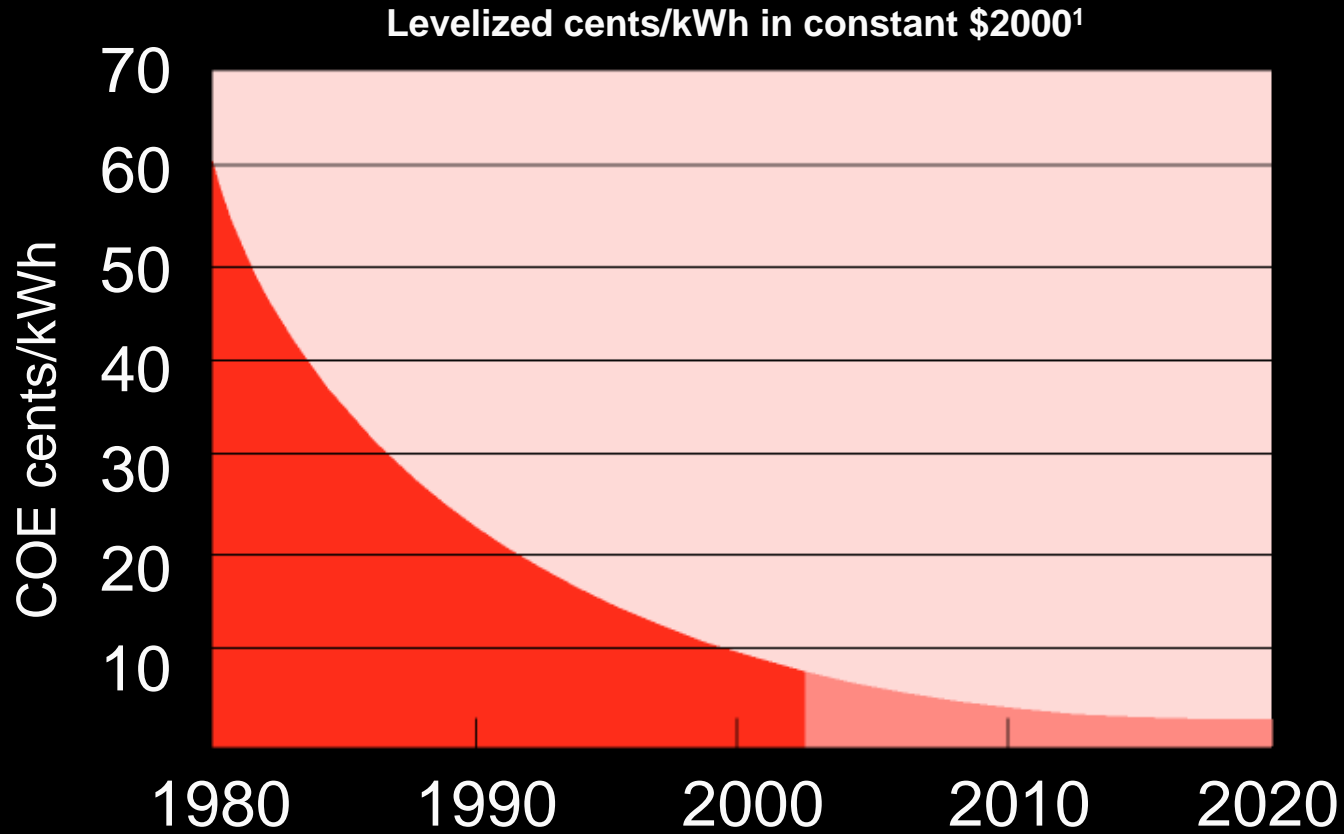



Solar Thermal Power Plant Potential

Comparably low power generation costs can be achieved wherever insolation reaches 1,900 kWh per square meter and year or more.

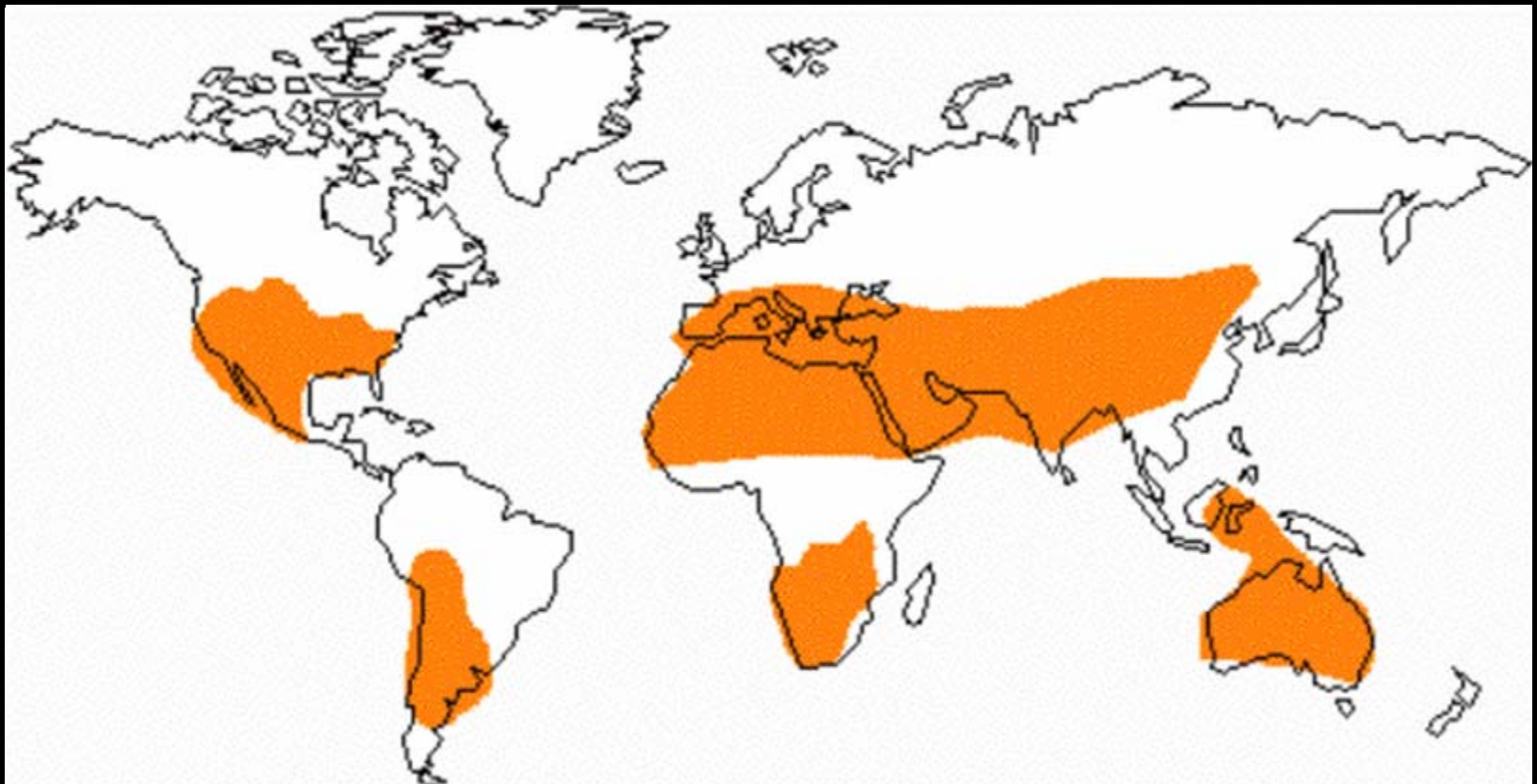



Photovoltaic Energy Conversion

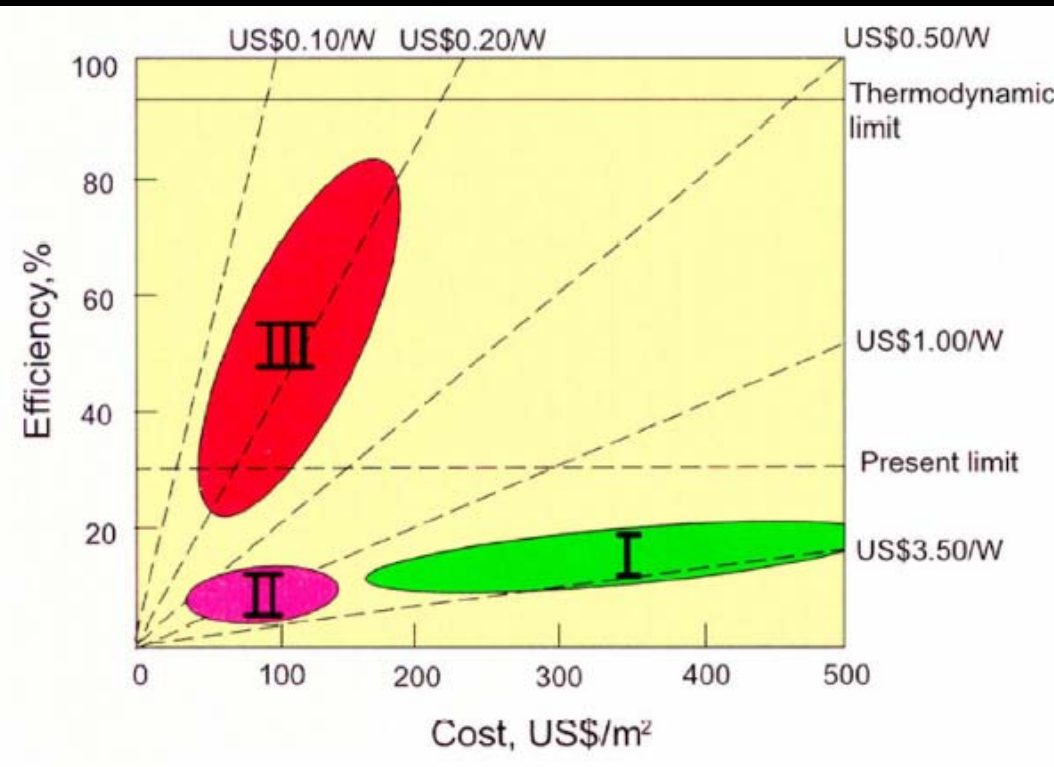

First generation (I): Crystalline PV

Second generation (II): Thin Film PV

Third generation (III): Based on nanotechnology using collections of atoms of semiconducting material. Films containing nanocrystalline structures and nanostructured conducting polymers are designed to absorb much of the solar spectrum. This technology will lead to PV cells made from thinly stacked plastic sheets converting solar energy to electricity with very high efficiency and at very low cost.

Photoelectrochemistry, an area of confluence between solar cell technology and battery or fuel cell technology, is playing role in the development of organic solar cells.



Cost of Photovoltaic Modules

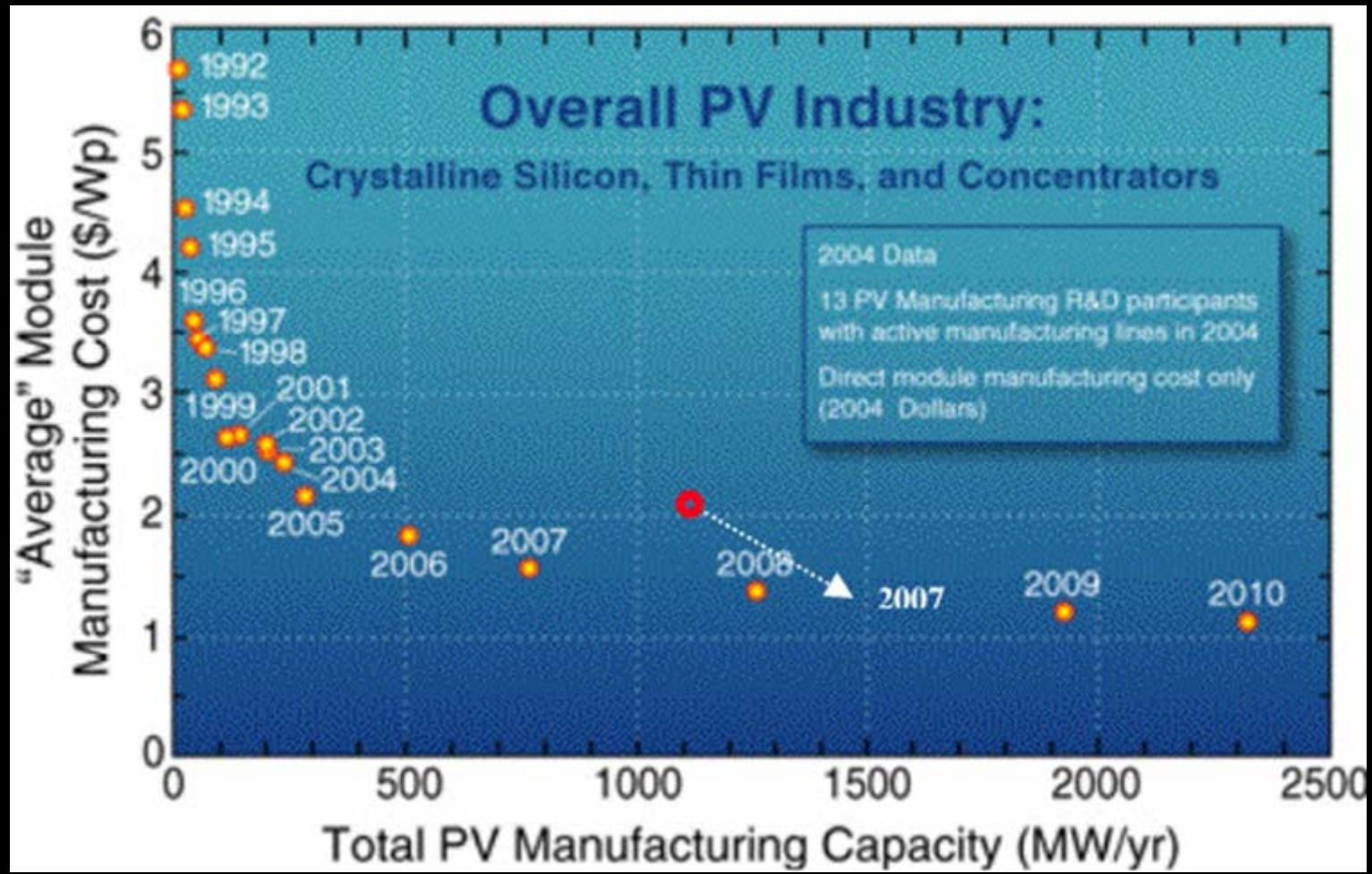

Starting in 2006 China's production: 400 MW_p/year



Photovoltaics Cost of Energy

Levelized cents/kWh in constant \$2000¹

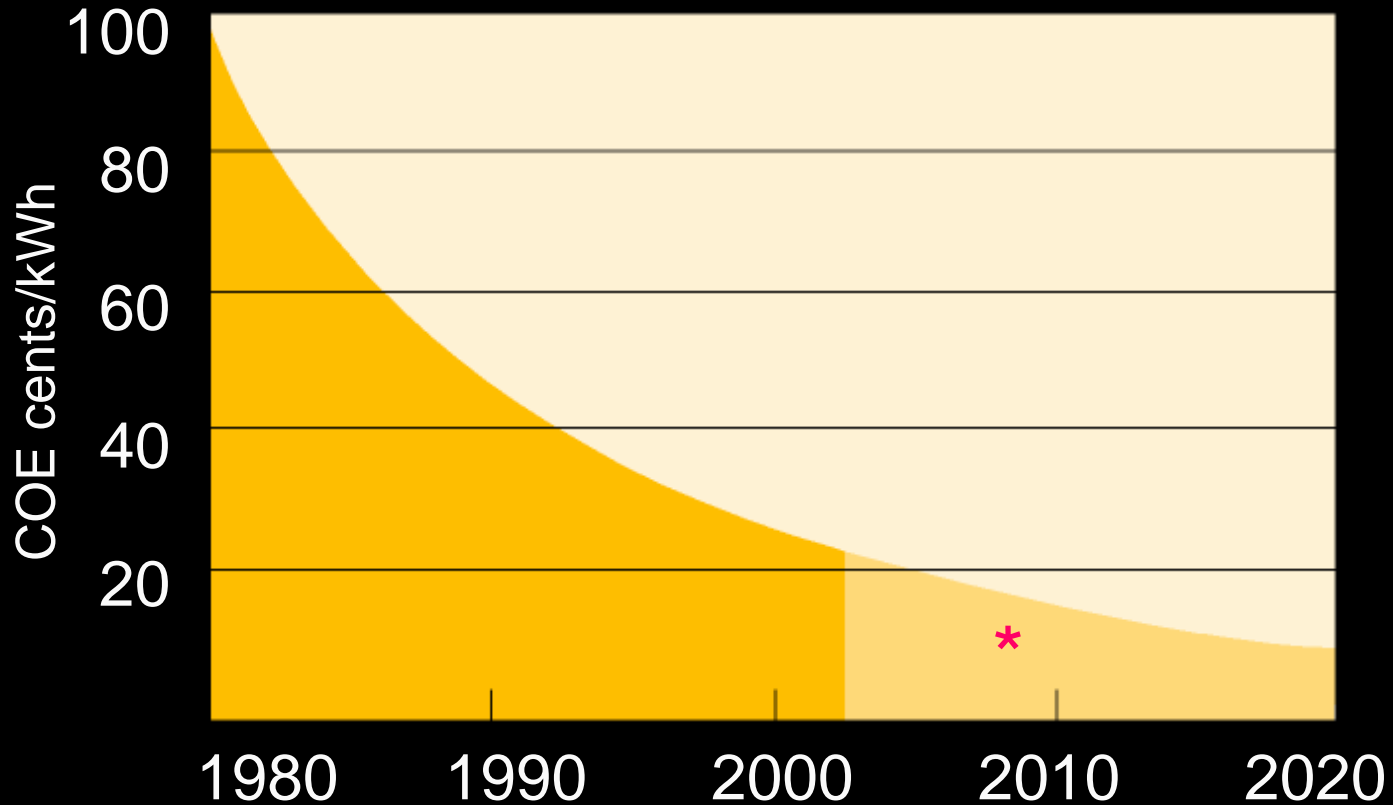

Peak electricity cost in USA: 11.3 cents/kWh



Power Cost

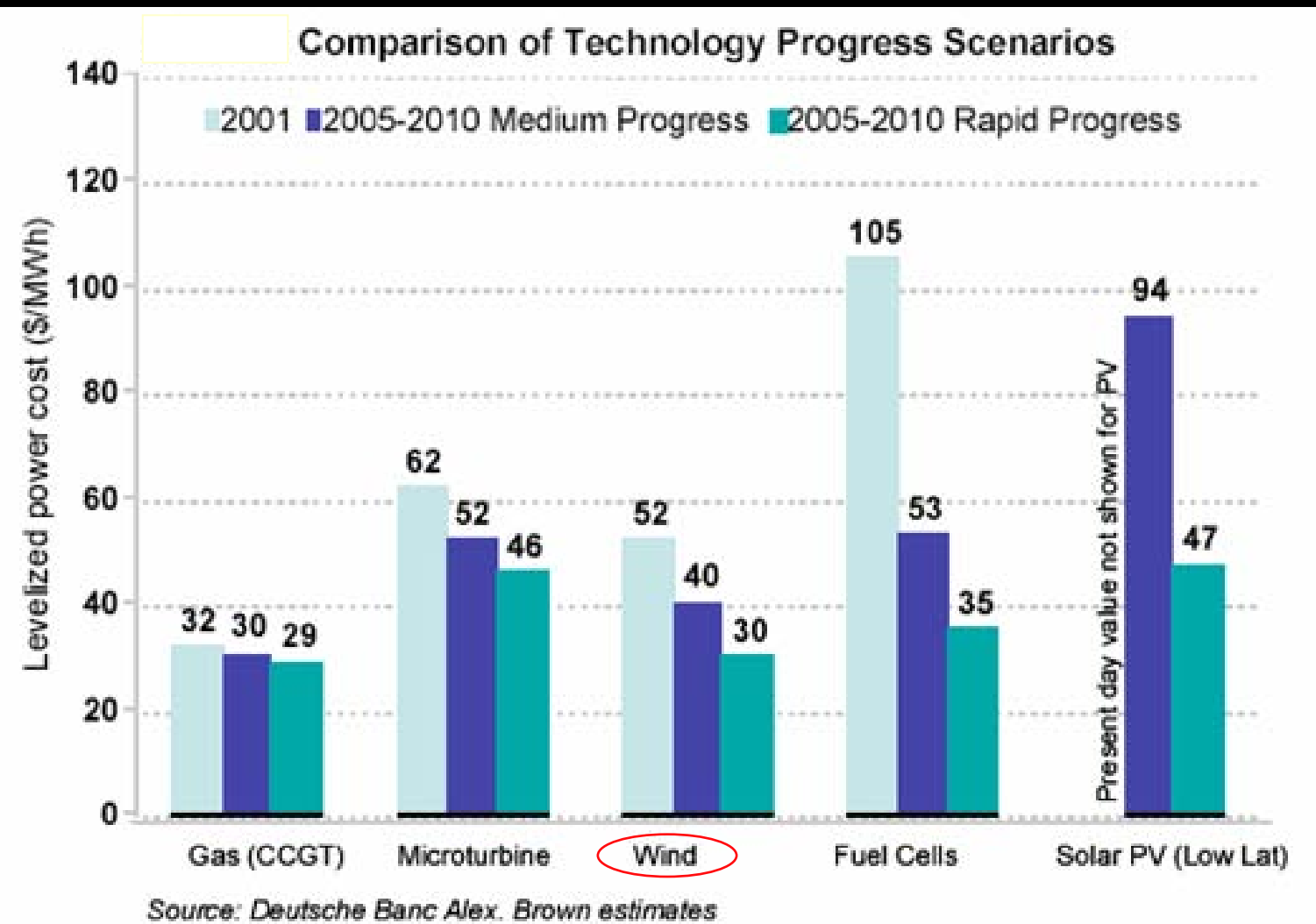



Renewable Energy Storage

Solar and wind energy sources are **intermittent and regional**.

They will become major sources of power if we find **efficient ways to store and transport their energy**.

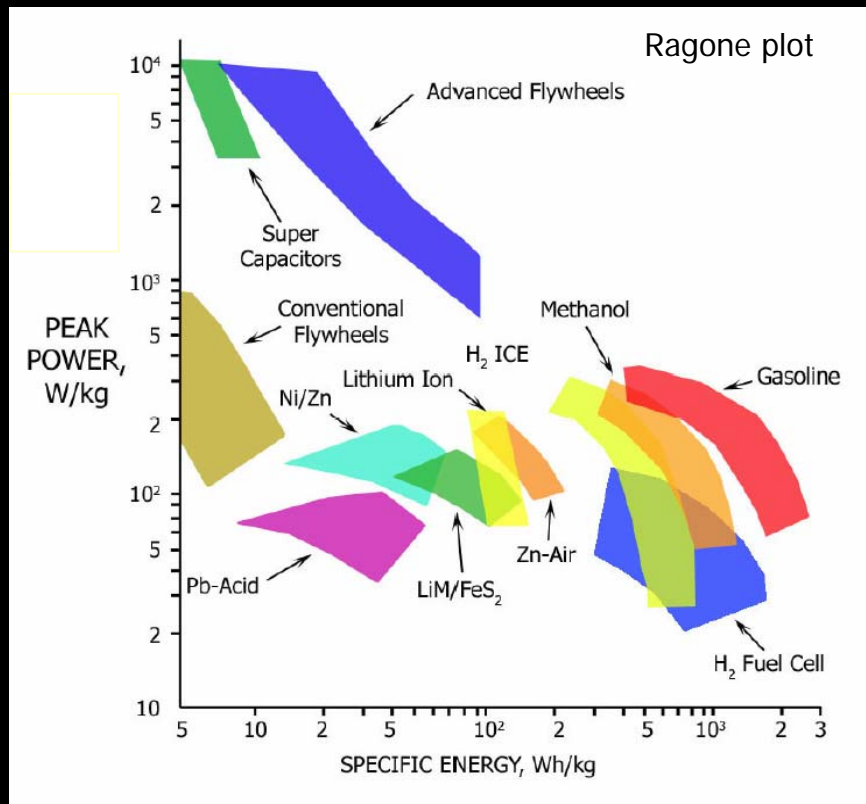

Source: J.W. Tester, Sustainable Energy, MIT, 2005



Renewable Energy Storage and Fuel for Transportation

Hydrogen, the simplest molecule, can be used for storing energy and make it available where and when it is needed.

When used as a chemical fuel, it does not pollute

Hydrogen is not an energy *source* , but it is an **energy carrier** that has to be manufactured like electricity.

Hydrogen can be manufactured from many primary sources (from clean water and solar energy) - reduces the chances of creating a cartel.

Hydrogen Cycle: electrolysis → storage → power conversion



Renewable Hydrogen Cost

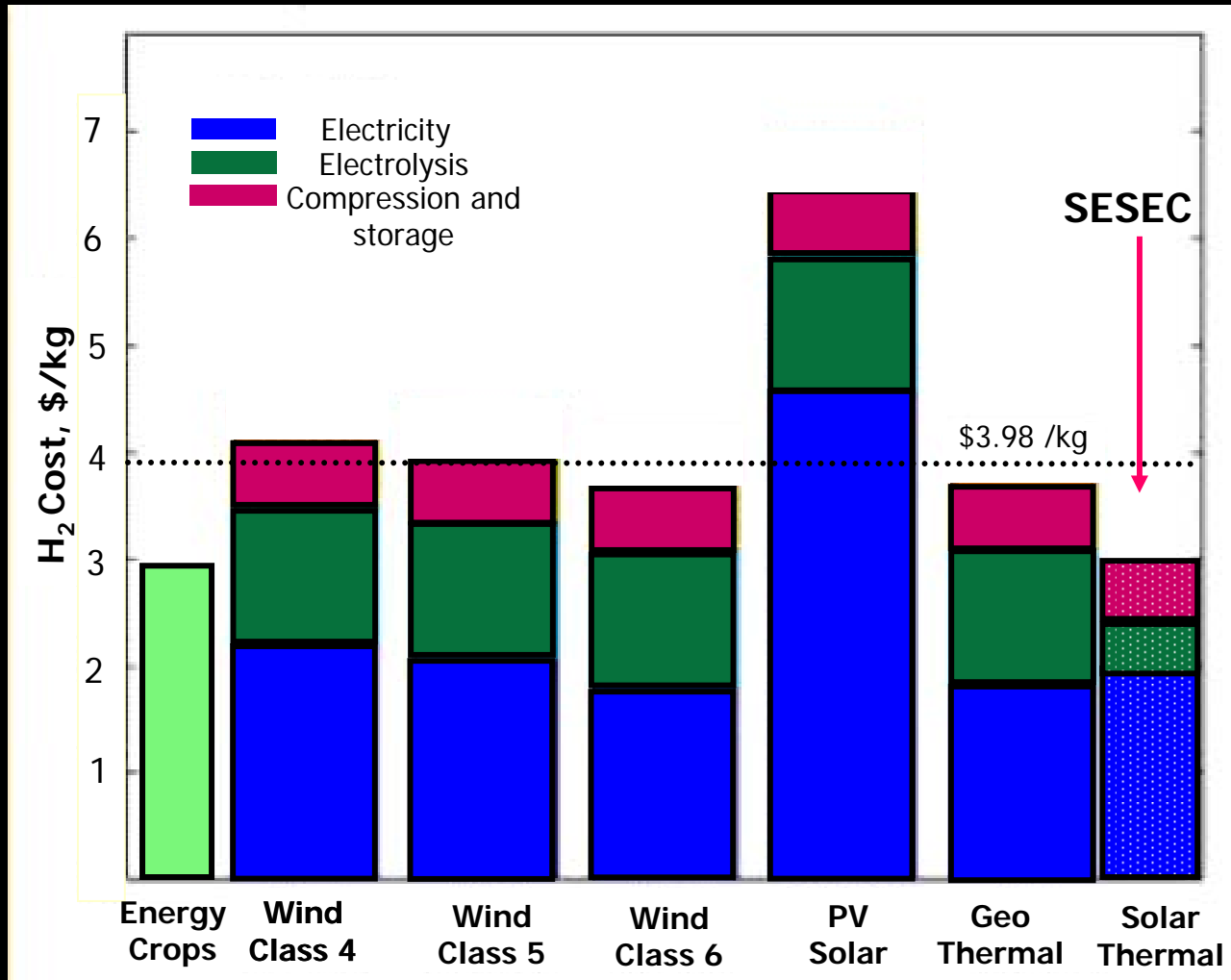

One Kg of hydrogen has roughly the same amount of energy as in one gallon of gasoline



SESEC Project - \$1000/ kW

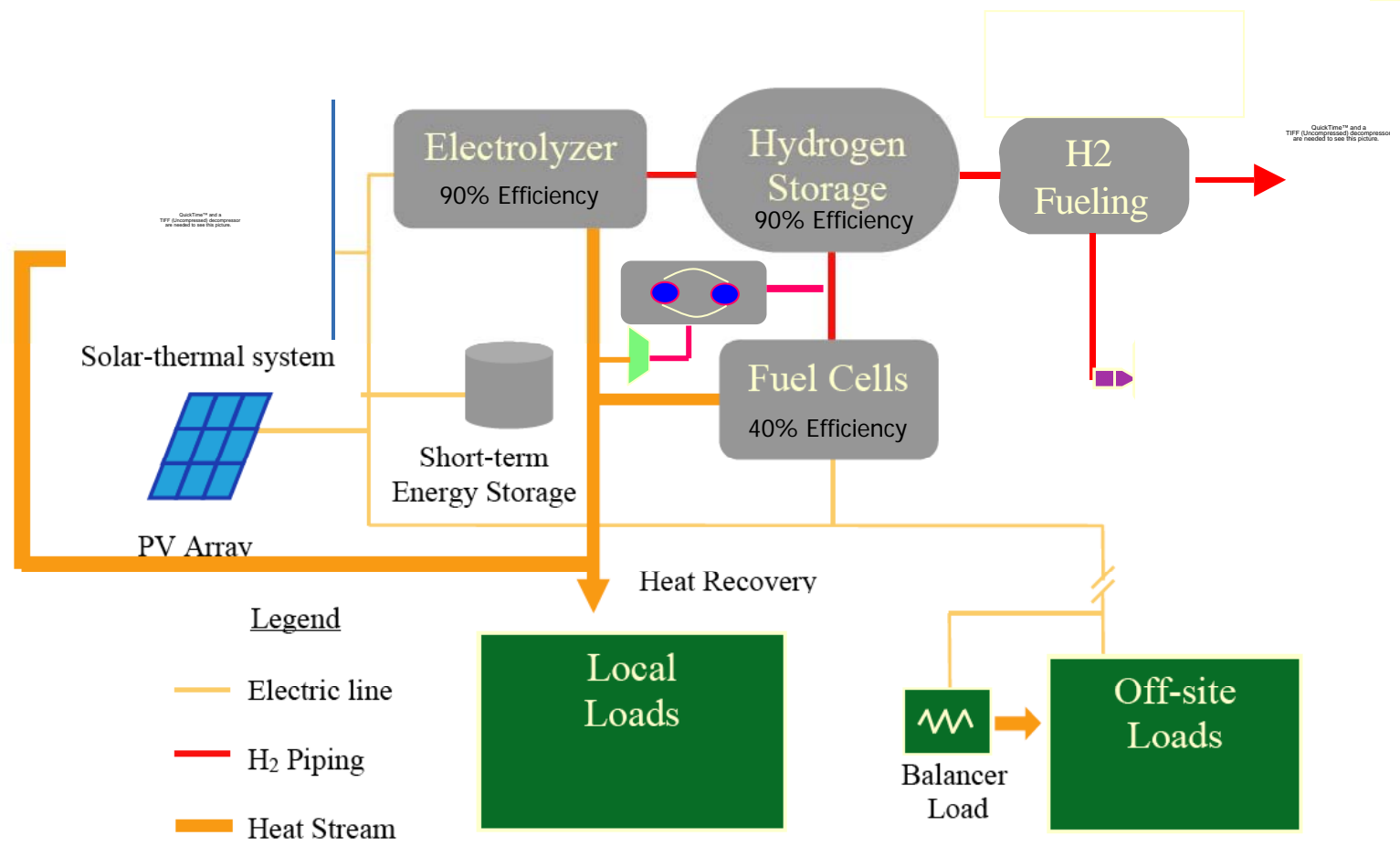

5 kW Solar-electricity & hydrogen generation System



Solar Concentrator

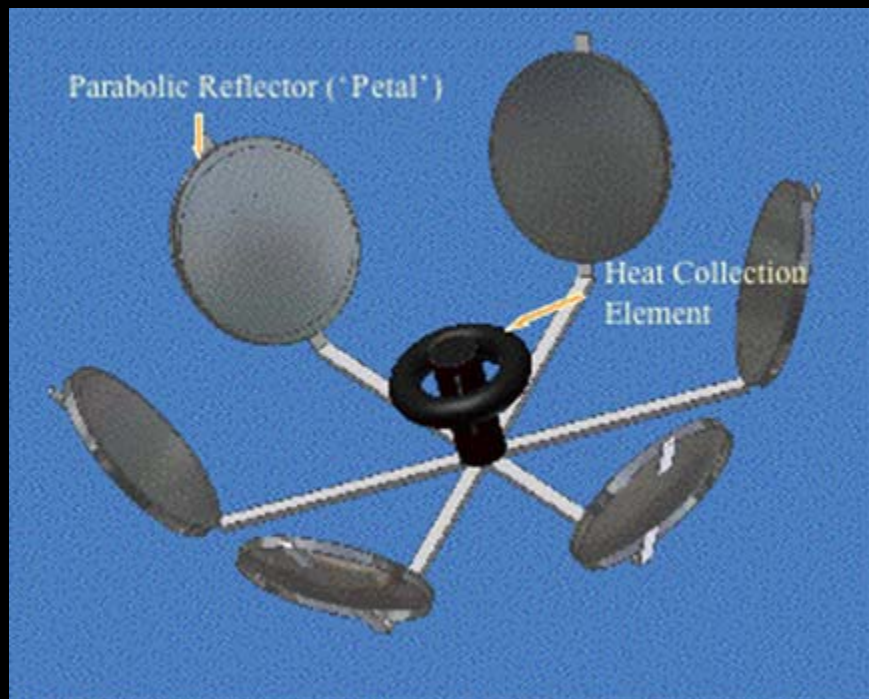

Steam generator

- Concentrates sunlight to a high temperature to 600K
 - Allows for the use of a heat engine for energy production at center focal point; ex. Tesla Turbine
- Each 'petal' independently moves and tracks the sun





Heat to Electrical Energy Conversion

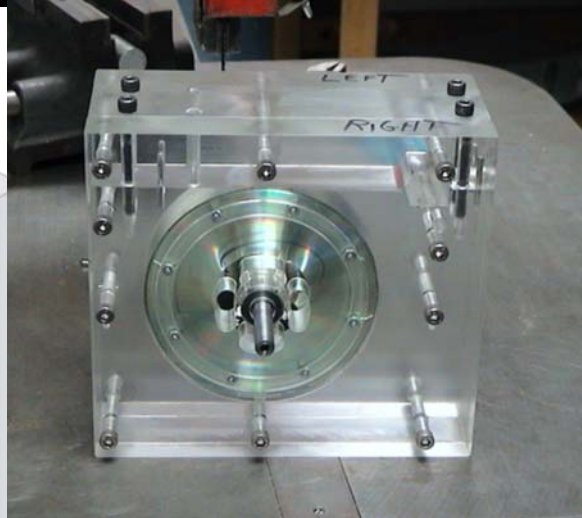
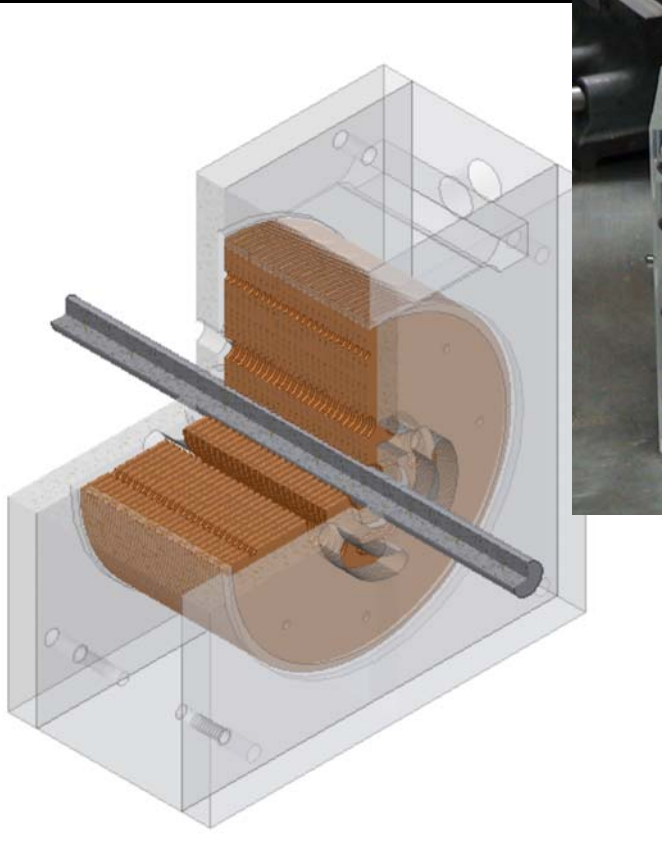

Tesla Turbine

Flow between Parallel closely spaced disks results in energy transfer to the shaft using the boundary layer effect

High efficiency, high RPM and low cost

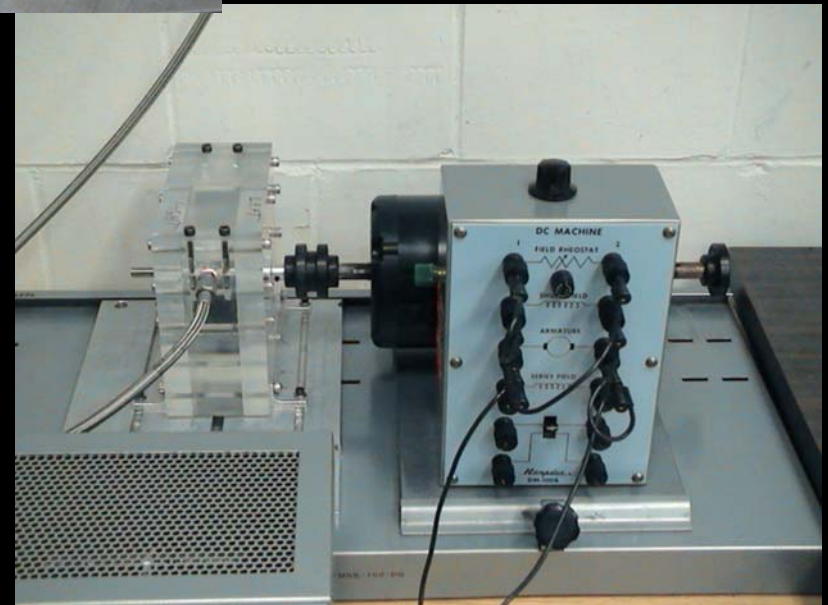



Electrode Performance

pH 14 at room temperature and pressure

Efficiency of Hydrogen Production in 1 M KOH

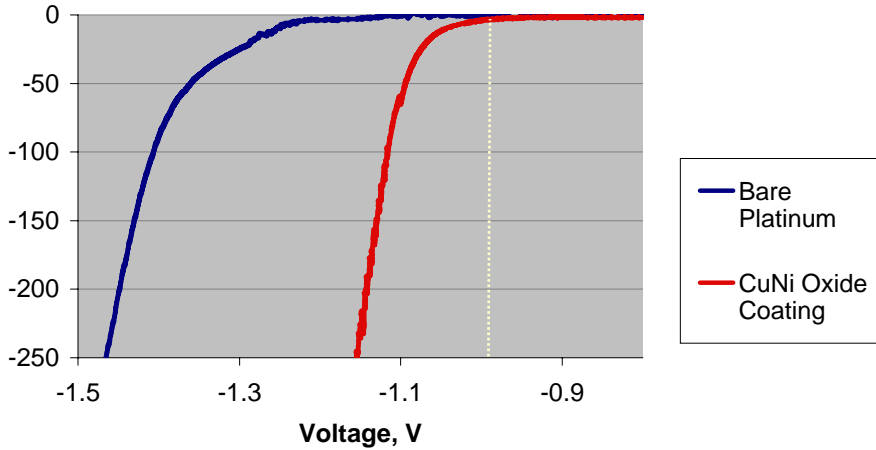

Efficiency of Oxygen Production in 1 M KOH

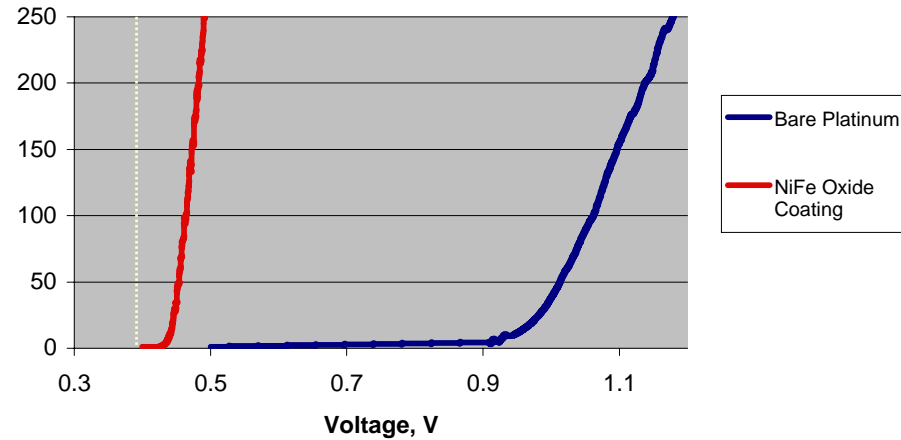

Voltage Measured at a Constant Current Density of 250 mA/cm²

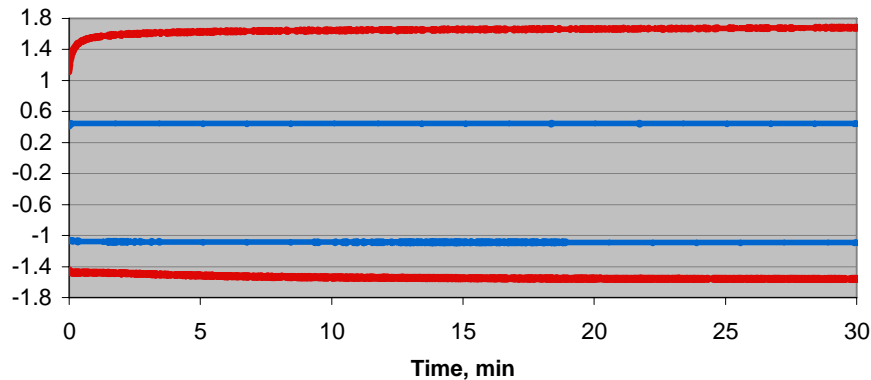

— Metal Oxide Coating

— Bare Platinum

$$V_{\text{total}} = V_{\text{oxidation}} - V_{\text{reduction}}$$



Electrode Performance

Comparison of Total Efficiency After 30 min of Constant Current Density

	Bare <u>Platinum</u>	Metal Oxide <u>Coatings</u>
10 mA/cm ²	54.0 %	95.9%
50 mA/cm ²	49.3 %	91.9%
250 mA/cm ²	41.4 %	85.5%

Efficiencies are based on the heat of formation of water from H₂ and O₂



Fuel Cell Efficiency

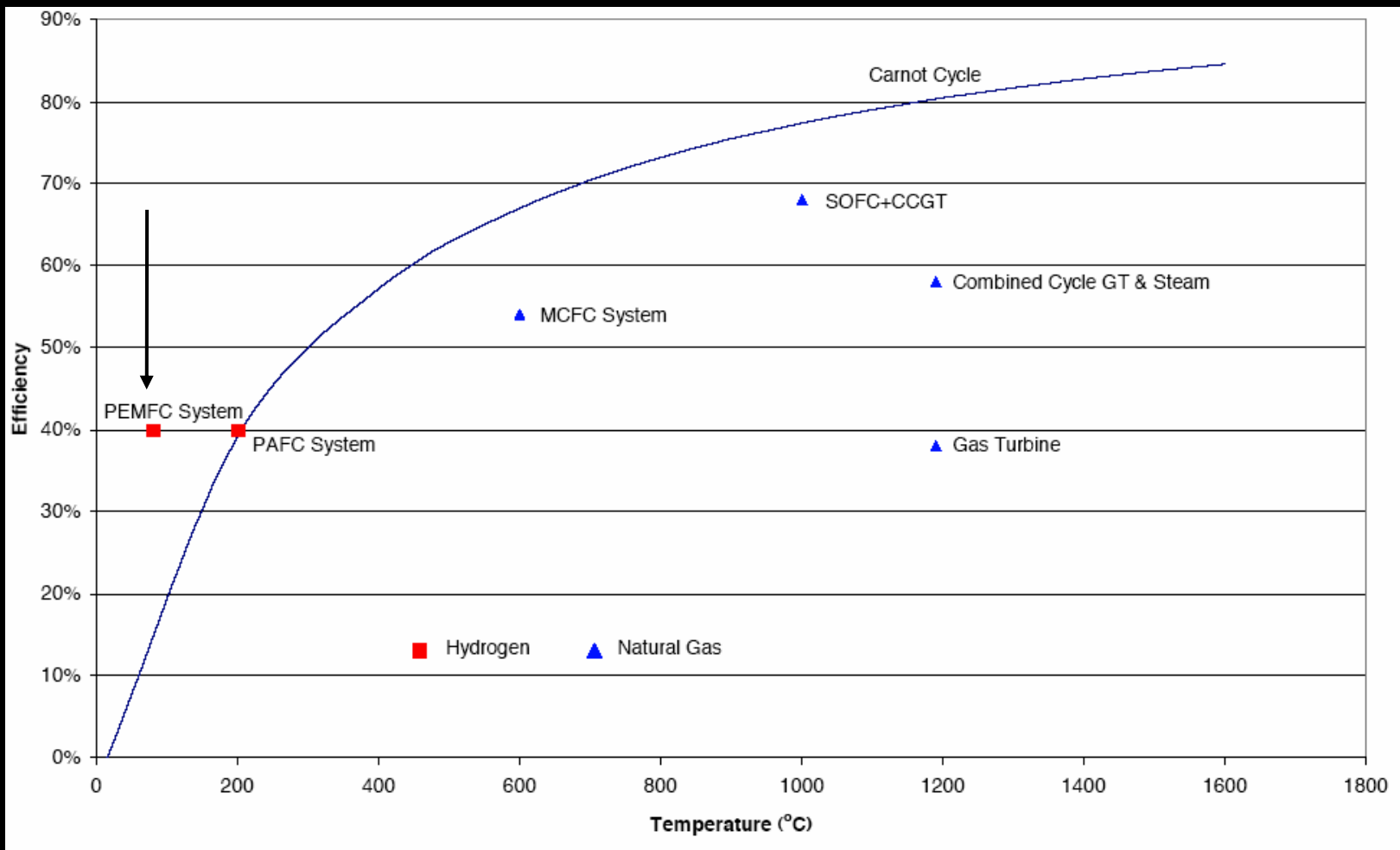



Fuel Cell System

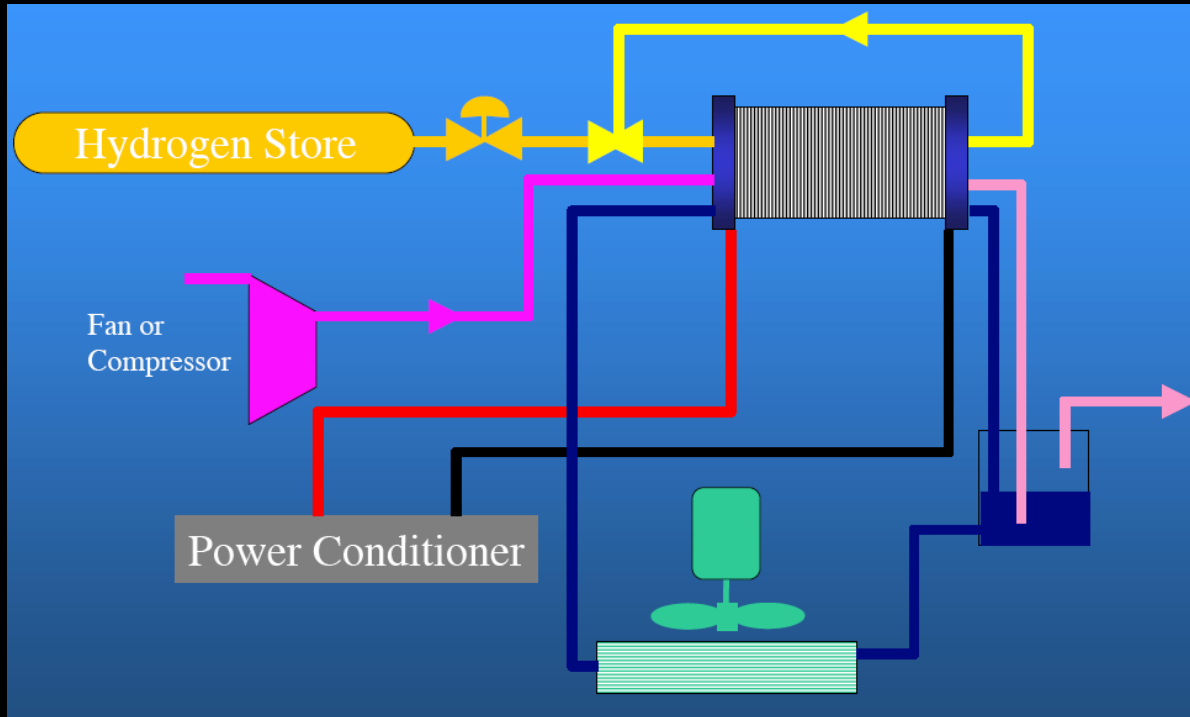

Fuel Cell Stack
Control System

Fuel Delivery

Air Delivery

Thermal Management

Water Management

Power Conditioning



Critical Materials and Costs

Example: Polymer Electrolyte Fuel Cell Stack (1 kW)

- Polymer membrane
- Catalyst (precious metals)
- Bipolar plate

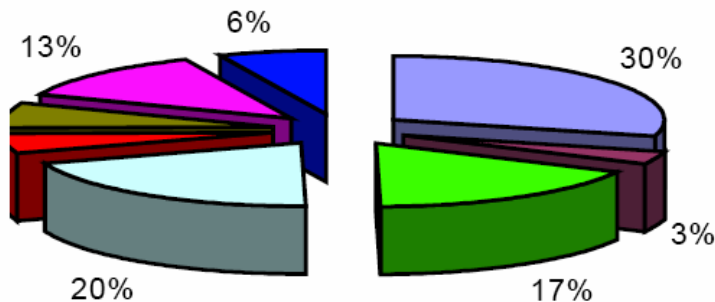

- MEA
- Gas diffusion layers
- Bipolar plates (material)
- Bipolar plates (processing)
- Sealings
- End plates and current collectors
- Assembly
- Quality control



Bipolar Plate

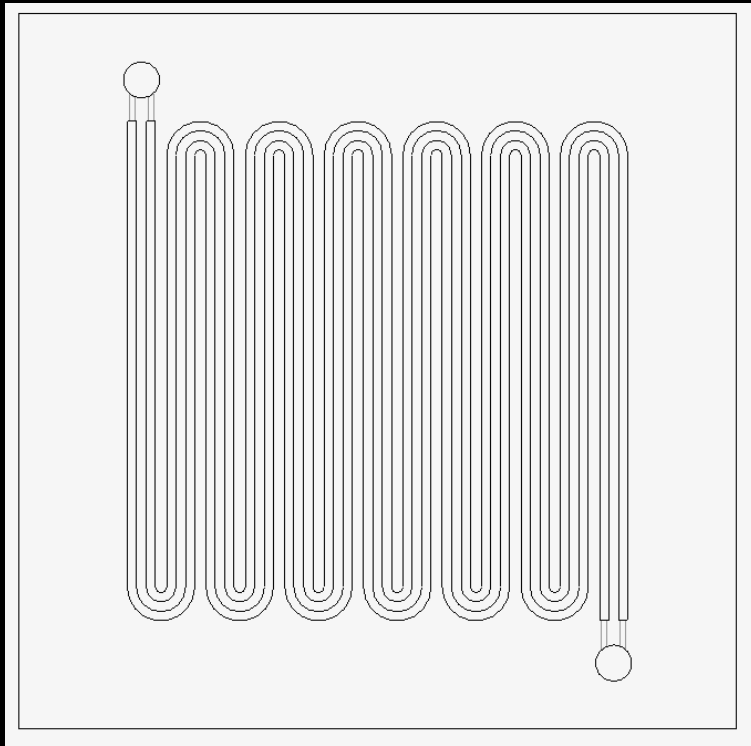

Conventional - Graphite

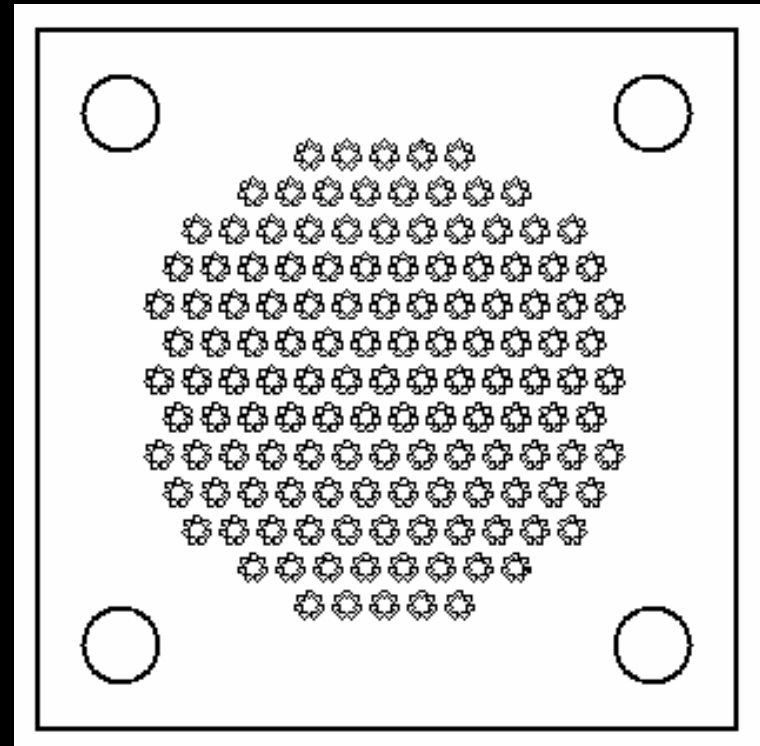

New Design - Thermoset Plastic
Microjet impingement



Conclusion

"Our world society is presently on a **nonsustainable** course." The West, especially, is in peril: "The prosperity that the First World enjoys at present is based on spending down its environmental capital." Calamity could come quickly: "A society's steep decline may begin only a decade or two after the society reaches its peak numbers, wealth and power."

'Collapse': How the World Ends - Jared Diamond (2004)



Skepticism

1. "Heavier-than-air flying machines are impossible" - *Lord Kelvin; 1885*
2. "I don't think this business of television is likely to come to much" - *Sir J.J. Thomson; 1930*
3. "The gas turbine could hardly be considered a feasible application to airplanes" - *US national academy of Sciences, Committee on Gas Turbines; 1940*
4. "It is time to close the book on infectious disease" - *US Surgeon-General ; 1969*
5. "There is no reason anyone would want a computer in their home" - *Ken Olson, Founder of DEC; 1977*
6. "640K ought to be enough for anybody" - *Bill Gates; 1981*



Humanity's Top Ten Problems for next 50 years

1. ENERGY
2. WATER
3. FOOD
4. ENVIRONMENT
5. POVERTY
6. TERRORISM & WAR
7. DISEASE
8. EDUCATION
9. DEMOCRACY
10. POPULATION



2003	6.5	Billion People
2050	8-10	Billion People



Inspiration

“When you are inspired by some great purpose, some extraordinary project, all your thoughts break their bonds, your mind transcends limitations, your consciousness expands in every direction, and you find yourself in a new, great and wonderful world.

Dormant forces, faculties and talents become alive, and you discover yourself to be a greater person by far than you ever dreamed yourself to be.”

Patanjali, - First to third century BC





World at Night

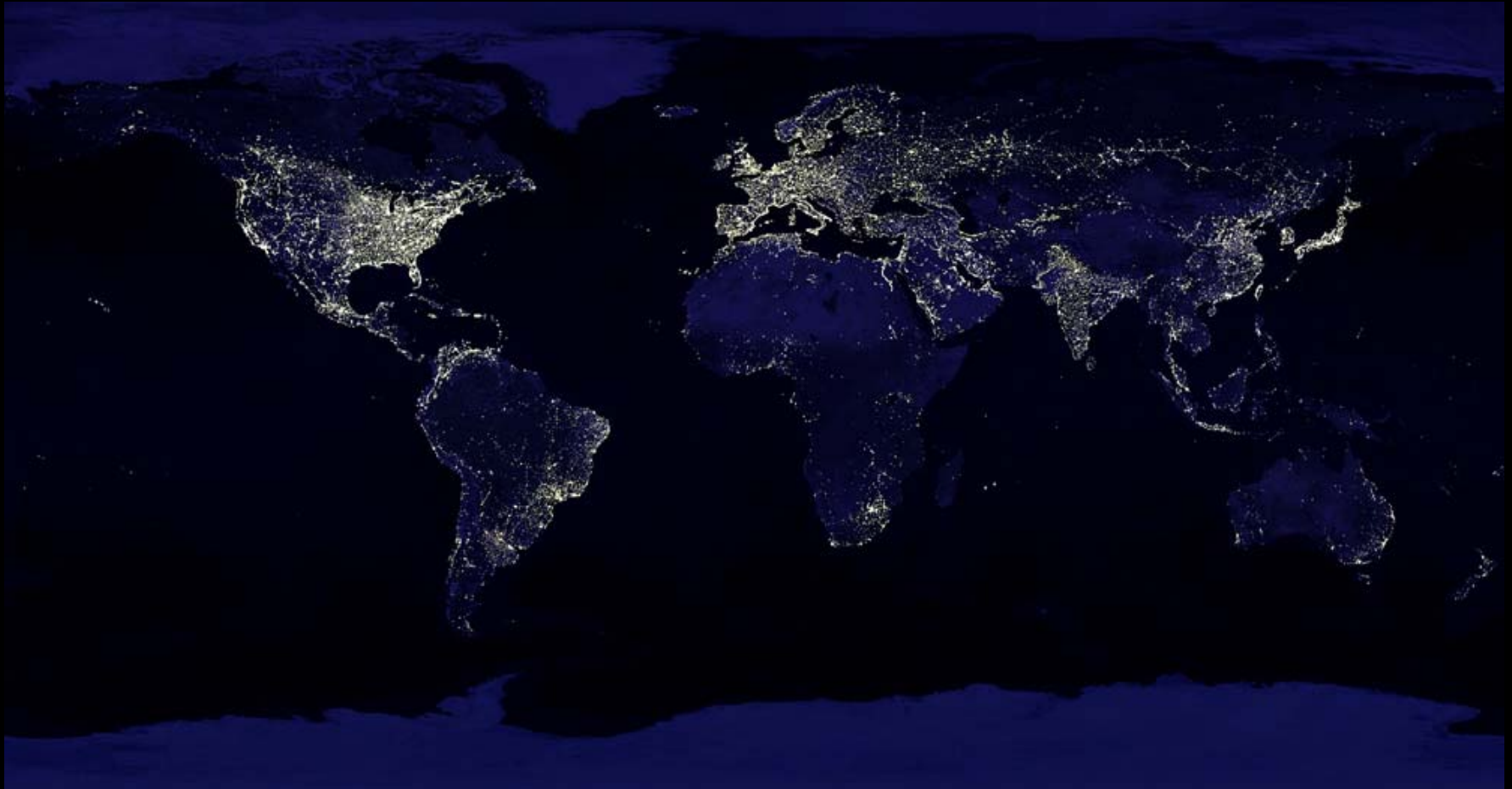

THANK YOU