

AN INTRODUCTION TO ENERGY SOURCES



**NATIONAL CENTRE FOR CATALYSIS RESEARCH
DEPARTMENT OF CHEMISTRY
INDIAN INSTITUTE OF TECHNOLOGY, MADRAS**

PREFACE

The reasons for the choice of energy sources are many. There is a need to know the options available and how to exploit them, the need to harness some of these sources efficiently and effectively and above all the environmental concerns these energy sources give rise to. The material presented in the form of an **e book** is mainly meant for higher secondary school students as the audience and for others this may be elementary unless otherwise one wishes to get some basis on this topic.

Each of the chapters has been prepared by the individual members of the National Centre for Catalysis Research keeping various factors in mind like the audience to whom the subject matter is addressed to and the level of knowledge required to follow the contents of the material. We do hope that this attempt has fulfilled all these expectations. However, it should be remembered that there can be serious shortcomings in the compilation. We do hope that the book in spite of these limitations may be useful to some extent.

The material contained in this **e book** was the subject matter of a summer term course delivered by the members of the National Centre for Catalysis Research to the participants of the Chemistry programme organized by Childrens' Club of Madras.

This is one of our first attempts to bring out an **e book** and this effort will be improved in the subsequent attempts only when appropriate feed back is given to us on various aspects of this endeavour. We will be grateful for any feed back sent to us to our email address bvnathan@iitm.ac.in.

We do hope our ebook will receive considerable number of hits from the people who seek to know about the possible energy sources.

Chennai 600 036
Dated 20th October 2006

B.Viswanathan

Contents

S. No.	Chapter	Page No.
1	Energy sources	3-8
2	Petroleum	9-34
3	Natural Gas	35-49
4	Coal	50-84
5	Nuclear Fission	85-101
6	Nuclear Fusion	102-114
7	Introduction to Batteries	115-134
8	Solid State Batteries	135-152
9	Fuel Cells	153-175
10	Super capacitors	176-195
11	Photo-voltaic cells	196-210
12	Photo-electrochemical Cells	211-227
13	Hydrogen Production	228-243
14	Hydrogen Storage	244-263
15	Biochemical Energy Conversion Processes	264-287

Chapter –1

ENERGY SOURCES

B. Viswanathan

The standard of living of the people of any country is considered to be proportional to the energy consumption by the people of that country. In one sense, the disparity one feels from country to country arises from the extent of accessible energy for the citizens of each country. Unfortunately, the world energy demands are mainly met by the fossil fuels today. The geographical non equi-distribution of this source and also the ability to acquire and also control the production and supply of this energy source have given rise to many issues and also the disparity in the standard of living. To illustrate the points that have been mentioned, it is necessary to analyze some data. In Table 1, the proved reserves of some of the fossil fuels are given on the basis of regions.

Table 1. Data on the proved reserves of fossil fuel on region-wise

Region/ OIL	Thousand Million barrels (1994)	Thousand Million barrels (2004)	R/P Ratio
North America	89.8	61	11.8
South and Central America	81.5	101.2	40.9
Europe and Eurasia	80.3	139.2	21.6
So called Middle East	661.7	733.9	81.6
Africa	65.0	112.2	33.1
Asia pacific	39.2	41.1	14.2
Total world	1017.5	1188.6	40.5
Region/Natural gas	Trillion cubic meters (1994)	Trillion cubic meters (2004)	R/P ratio
North America	8.42	7.32	9.6
South and central America	5.83	7.10	55.0
Europe and Eurasia	63.87	64.02	60.9
So called Middle east	45.56	72.83	*
Africa	9.13	14.06	96.9

Asia pacific	10.07	14.21	43.9
World	142.89	179.53	66.7
Region/COAL		Million tones (2004)	R/P ratio
North America		254432	235
South and central America		19893	290
Europe and Eurasia		287095	242
Africa and so called middle east		50755	204
Asia and pacific		296889	101
World		909064	164

The world energy consumption pattern is also increasing as shown in the Fig.1. The energy consumption has been increasing and it will triple in a period of 50 years by 2025 as seen from Fig.1. Data on fossil fuel consumption by fuel type are given in Table 2. The fossil fuel use as energy source has many limitations. There are a number of pollutants that have been identified as coming out of the use of fossil fuels and they are serious health hazards. A simple compilation of the type of effects of the pollutants from fossil fuel sources is given in Table 3.

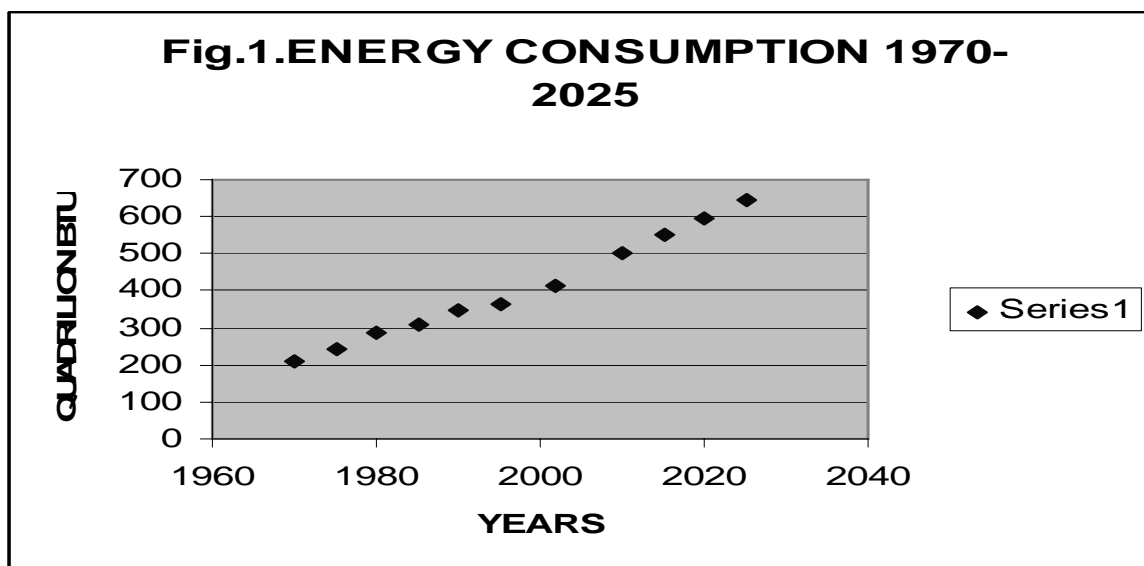

Fig.1. World energy consumption pattern

Table 2. Energy consumption by fuel type (in million tones of oil equivalent) for the year 2004

Region	Oil	Gas	Coal	Nuclear energy	Hydro-electricity	Total
North America	1122.4	705.9	603.8	210.4	141.9	2784.4
South & central America	221.7	106.2	18.7	4.4	132.1	483.1
Europe and Eurasia	957.3	997.7	537.2	287.2	184.7	2964.0
So called Middle east	250.9	218.0	9.1	-	4.0	481.9
Africa	124.3	61.8	102.8	3.4	19.8	312.1
Asia Pacific	1090.5	330.9	1506.6	118.9	152.0	3198.8
World	3767.1	242.4	2778.2	624.3	634.4	10224.4

The scene of energy resources have been visualized in terms of various parameters. Mainly the population increase and also the need to increase the standard of living are the factors forcing to see new and alternate energy options. The climate change which is threatening the existence of life is another factor forcing to consider alternate energy sources. However the energy sources to be adopted will have to meet the varying needs of different countries and at the same time enhance the security of each one against the energy crisis or energy shortage that have taken place in the past. The factors that need consideration for the search for new energy sources should include:

- (i) The global energy situation and demand
- (ii) The availability of fossil sources
- (iii) The efficiency of the energy sources
- (iv) The availability of renewable sources
- (v) The options for nuclear fission and fusion.

The world population will increase from 6 billion to 11 billion in this century and the life expectancy has increased 2 times in the last two centuries and the energy requirement has increased 35 times in the same period. The main drivers of the alternate energy search are the population growth, economy, technology, and agriculture. This energy demand will be in the non OECD countries and it is expected that in china alone the energy demand will increase by 20% and this will shift the oil export from west to other non

OECD countries. Need for new and carbon free energy sources and possibly electricity demand will go up in the coming years.

Energy from Nuclear fission though can be conceived as an alternate for the production the necessary electrical energy, the current available technologies and reactors may not be able to meet this demand. A global integrated system encompassing the complete fuel cycle, water management, and fissile fuel breeding have to be evolved for this source of energy to be a viable option.

The renewable energy sources are not brought into main stream energy resources though occasionally we hear the use of low quality biomass as a source in some form or the other. The carbon dioxide emission must be controlled in the vicinity of 600 to 650 ppm in the period of 2030 to 2080. The exact slope of the curve is not a matter of concern the cumulative amount of the carbon dioxide emission will be a factor to reckon with.

Therefore the alternative for energy supply should include fossil fuel with carbon dioxide sequestration, nuclear energy and renewable energies. Possibly fusion and also hydrogen based energy carrier system will evolve. However, the costs involved may even force the shift to the use of coal as an energy source in countries like India and China.

The adaptation of new energy sources also faces some limitations. One is not sure of the feasibility and sustainability of such an energy source, and the learning curve also has very limited gradient making investments restrictive.

Even though collaborative ventures between nations may be one option from the point of view of investment, it is not certain whether any country will be willing to deploy giga watts power not directly produced in the country of consumption. This is mainly due to the experience from energy disruptions in the past and also the small elasticity of the energy market. Countries will opt for a diversity of energy supply rather than depend on a mega scale power plants since the possibility of alternate suppliers will be more acceptable than the inter dependent supplies across countries, economy and administration.

There are a variety of energy resources and energy forms. These include hydro power, wind, solar, biomass and geothermal for resources and in the energy forms, light, heat, electricity, hydrogen and fuel. How this transition has to occur depends on many factors

but surely the transition has to take place sooner or later. What kind of mix will be required also depends on the location and also the availability of the resources. Photovoltaic devices have been advocated as a powerful energy source, but the technology still needs high investment and also the reliability and sustainability questions have to be addressed.

Table 3. Effect of pollutants on Human beings

Types	Effects
Primary pollutants	
CO	Heart disease, strokes, pneumonia, pulmonary tuberculosis, congestion of brain and lungs.
SO _x	Acute respiratory infection (chronic pulmonary or cardiac disorders)
NO _x	Chronic respiratory infection (chronic bronchitis, emphysema and pulmonary oedema)
HC	Lung and stomach cancer
SP	Tissue destruction of the respiratory epithelium (deleterious effects on the lining of the nose, sinus, throat and lungs) cancer
Pb and PbO _x	Brain damage, cumulative poisoning (absorbed in red blood cells and bone marrow.
Secondary pollutants	
PAN and NO ₂	Attacks of acute asthma and allergic respiratory infections (chronic bronchitis and emphysema).
O ₃	Chest constriction, irritation of mucous membrane, headache, coughing and exhaustion.
Aerosols	
SO ₄ ²⁻ and NO ₃ ⁻	Asthma, infant mortality and acute respiratory infections
Others	
Aldehydes, olefins, nitroamines PAH	Respiratory tract carcinoma
Acrolein	Irritation to eyes

Chapter – 2

PETROLEUM

S. Chandravathanam

1. Introduction

Petroleum is oily, flammable, thick dark brown or greenish liquid that occurs naturally in deposits, usually beneath the surface of the earth; it is also called as crude oil. Petroleum means *rock oil*, (Petra – rock, elaion – oil, Greek and oleum – oil, Latin), the name inherited for its discovery from the sedimentary rocks. It is used mostly for producing fuel oil, which is the primary energy source today. Petroleum is also the raw material for many chemical products, including solvents, fertilizers, pesticides and plastics. For its high demand in our day-to-day life, it is also called as ‘*black gold*’.

Oil in general has been used since early human history to keep fires ablaze, and also for warfare. Its importance in the world economy evolved slowly. Wood and coal were used to heat and cook, while whale oil was used for lighting. Whale oil however, produced a black, smelly, thick liquid known as tar or rock oil and was seen as a substance to avoid.

When the whaling industry hunted the sperm whale almost to extinction and the industrial revolution needed a fuel to run generators and engines, a new source of energy was needed. In the search for new products, it was discovered that, from crude oil or petroleum, kerosene could be extracted and used as a light and heating fuel. Petroleum was in great demand by the end of the 1800’s, forcing the creation of the petroleum industry.

Petroleum is often considered the lifeblood of nearly all other industry. For its high energy content (Table-1) and ease of use, petroleum remains as the primary energy source.

Table1. Energy density of different fossil fuels

Fuel	Energy Density
Petroleum or Crude oil	45 MJ/Kg
Coal	24 MJ/Kg
Natural Gas	34 – 38 MJ/m ³

Oil accounts for 40% of the United States' energy supply and a comparable percentage of the world's energy supply. The United States currently consumes 7.5 billion barrels (1.2 km³, 1 barrel = 159 litre or 35 gallon) of oil per year, while the world at large consumes 30 billion barrels (4.8 km³). Petroleum is unequally distributed throughout the world. The United States, and most of the world, are net importers of the resource.

2. Origin of Petroleum

2.1. Biogenic theory

Most geologists view crude oil, like coal and natural gas, as the product of compression and heating of ancient vegetation over geological time scales. According to this theory, it is formed from the decayed remains of prehistoric marine animals and terrestrial plants. Over many centuries this organic matter, mixed with mud, is buried under thick sedimentary layers of material. The resulting high levels of heat and pressure cause the remains to metamorphose, first into a waxy material known as kerogen, and then into liquid and gaseous hydrocarbons in a process known as catagenesis. These then migrate through adjacent rock layers until they become trapped underground in porous rocks called reservoirs, forming an oil field, from which the liquid can be extracted by drilling and pumping. 150 m is generally considered the "oil window". Though this corresponds to different depths for different locations around the world, a 'typical' depth for an oil window might be 4-5 km. Three situations must be present for oil reservoirs to form: a rich source rock, a migration conduit, and a trap (seal) that forms the reservoir.

The reactions that produce oil and natural gas are often modeled as first order breakdown reactions, where kerogen breaks down to oil and natural gas by another set of reactions.

2.2. Abiogenic theory

In 1866, Berthelot proposed that carbides are formed by the action of alkali metal on carbonates. These carbides react with water to give rise to large quantities of acetylene, which in turn is converted to petroleum at elevated temperatures and pressures. For example, one can write the sequence as follows:

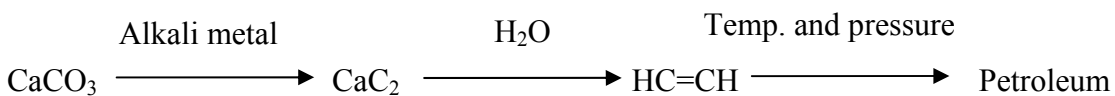

Mendelejeff proposed another reaction sequence involving acetylene in the formation of petroleum. He proposed that dilute acids or hot water react with the carbides of iron and

manganese to produce a mixture of hydrocarbons from which petroleum could have evolved. The reaction sequence according to the proposal of Mendelejeff is:

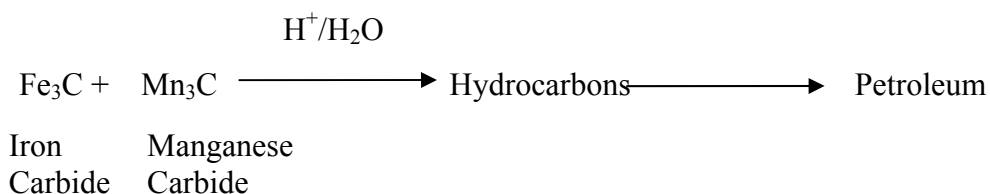

These postulates based on inorganic chemicals, though interesting, cannot be completely accepted for the following three reasons:

1. One often finds optical activity in petroleum constituents which could not have been present if the source of petroleum were only these inorganic chemicals.
2. Secondly, the presence of thermo-labile organic constituents (biomarkers) in petroleum cannot be accounted for in terms of origin from these inorganic chemicals.
3. It is known that oil is exclusively found in sedimentary rocks, which would not have been the case if the origin of oil could be attributed to processes involving only these inorganic chemicals.

The theory is a minority opinion amongst geologists. This theory often pops up when scientists are not able to explain apparent oil inflows into certain oil reservoirs. These instances are rare.

In 1911, Engler proposed that an organic substance other than coal was the source material of petroleum. He proposed the following three stages of development;

1. In the first stage, animal and vegetable deposits accumulate at the bottom of inland seas and are then decomposed by bacteria, the water soluble components are removed and fats, waxes and other fat-soluble and stable materials remain.
2. In the second stage, high temperature and pressure cause carbon dioxide to be produced from carboxyl-containing compounds, and water is produced from the hydroxyl acids and alcohols to yield a bituminous residue. There can also be a little cracking, producing a liquid product with a high olefin content (petropetroleum).
3. In the third stage, the unsaturated compounds are polymerized to naphthenic and/or paraffinic hydrocarbons. Aromatics are presumed to be formed either by cracking and cyclization or decomposition of petroleum. The elements of this theory has survived; the only objection to it is that the end products obtained from the same sequence of

experiments namely, paraffins and unsaturated hydrocarbons differ from those of petroleum.

3. Composition of Petroleum

Petroleum is a combination of gaseous, liquid and solid mixtures of many alkanes. It consists principally of a mixture of hydrocarbons, with traces of various nitrogenous and sulfurous compounds. Gaseous petroleum consists of lighter hydrocarbons with abundant methane content and is termed as 'natural gas'. Liquid petroleum not only consists of liquid hydrocarbons but also includes dissolved gases, waxes (solid hydrocarbons) and bituminous material. Solid petroleum consists of heavier hydrocarbons and this bituminous material is usually referred to as bitumen or asphalt. Along with these, petroleum also contains smaller amounts of nickel, vanadium and other elements.

Large deposits of petroleum have been found in widely different parts of the world and their chemical composition varies greatly. Consequently the elemental composition of petroleum vary greatly from crude oil to crude oil. It is not surprising that the composition varies, since the local distribution of plant, animal and marine life is quite varied and presumably was similarly varied when the petroleum precursors formed. Furthermore, the geological history of each deposit is different and allows for varying chemistry to have occurred as the organic matter originally deposited matured into petroleum.

Table 2. Overall tank Composition of Petroleum

Element	Percentage composition
Carbon	83.0-87.0
Hydrogen	10.0-14.0
Nitrogen	0.1-2.0
Sulphur	0.05-6.0
Oxygen	0.05-1.5

Petroleum also contains trace levels of nickel and vanadium (≈ 1000 ppm).

4. Production or Extraction of Petroleum

Locating an oil field is the first obstacle to be overcome. Today, petroleum engineers use instruments such as gravimeters and magnetometers in the search for petroleum. Generally, the first stage in the extraction of crude oil is to drill a well into the underground reservoir. Often many wells (called multilateral wells) are drilled into the same reservoir, to ensure that the extraction rate will be economically viable. Also, some wells (secondary wells) may be used to pump water, steam, acids or various gas mixtures into the reservoir to raise or maintain the reservoir pressure, and so maintain an economic extraction rate.

4.1. Primary oil recovery

If the underground pressure in the oil reservoir is sufficient, then the oil will be forced to the surface under this pressure. Gaseous fuels or natural gas are usually present, which also supply needed underground pressure. In this situation, it is sufficient to place a complex arrangement of valves on the well head to connect the well to a pipeline network for storage and processing. This is called primary oil recovery. Usually, only about 20% of the oil in a reservoir can be extracted this way.

4.2. Secondary oil recovery

Over the lifetime of the well, the pressure will fall, and at some point there will be insufficient underground pressure to force the oil to the surface. If economical, and it often is, the remaining oil in the well is extracted using secondary oil recovery methods. Secondary oil recovery uses various techniques to aid in recovering oil from depleted or low-pressure reservoirs. Sometimes pumps, such as beam pumps and electrical submersible pumps are used to bring the oil to the surface. Other secondary recovery techniques increase the reservoir's pressure by water injection, natural gas re-injection and gas lift, which injects air, carbon dioxide or some other gas into the reservoir. Together, primary and secondary recovery allow 25% to 35% of the reservoir's oil to be recovered.

4.3 Tertiary oil recovery

Tertiary oil recovery reduces the oil's viscosity to increase oil production. Tertiary recovery is started when secondary oil recovery techniques are no longer enough to sustain production, but only when the oil can still be extracted profitably. This depends

on the cost of the extraction method and the current price of crude oil. When prices are high, previously unprofitable wells are brought back into production and when they are low, production is curtailed. Thermally enhanced oil recovery methods (TEOR) are tertiary recovery techniques that heat the oil and make it easier to extract.

- Steam injection is the most common form of TEOR, and is often done with a cogeneration plant. In this type of cogeneration plant, a gas turbine is used to generate electricity and the waste heat is used to produce steam, which is then injected into the reservoir.
- In-situ burning is another form of TEOR, but instead of steam, some of the oil is burned to heat the surrounding oil.
- Occasionally, detergents are also used to decrease oil viscosity.

Tertiary recovery allows another 5% to 15% of the reservoir's oil to be recovered.

5. Petroleum Refining

The petroleum industry can be divided into two broad groups: *upstream* producers (exploration, development and production of crude oil or natural gas) and downstream transporters (tanker, pipeline transport), refiners, retailers, and consumers.

Raw oil or unprocessed crude oil is not very useful in the form it comes in out of the ground. It needs to be broken down into parts and refined before use in a solid material such as plastics and foams, or as petroleum fossil fuels as in the case of automobile and air plane engines. An oil refinery is an industrial process plant where crude oil is processed in three ways in order to be useful petroleum products.

i) Separation - separates crude oil into various fractions

Oil can be used in so many various ways because it contains hydrocarbons of varying molecular masses and lengths such as paraffins, aromatics, naphthenes (or cycloalkanes), alkenes, dienes, and alkynes. Hydrocarbons are molecules of varying length and complexity made of hydrogen and carbon. The trick in the separation of different streams in oil refinement process is the difference in boiling points between the hydrocarbons, which means they can be separated by distillation. Fig. 1 shows the typical distillation scheme of an oil refinery.

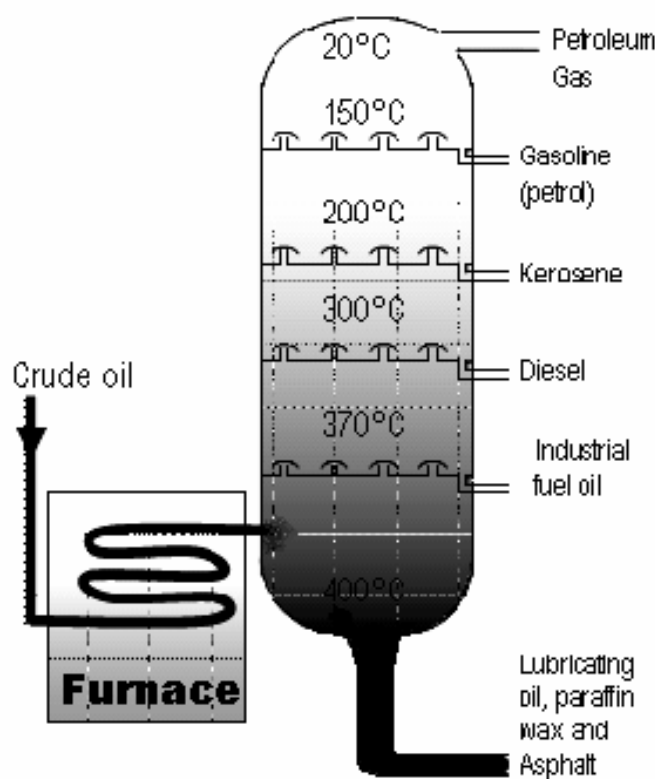

Fig. 1. Schematic of the distillation of crude oil

ii) Conversion – conversion to selectable products by skeletal alteration

Once separated and any contaminants and impurities have been removed, the oil can be either sold without any further processing, or smaller molecules such as isobutene and propylene or butylenes can be recombined to meet specified octane number requirements by processes such as alkylation or less commonly, dimerization. Octane number requirement can also be improved by catalytic reforming, which strips hydrogen out of hydrocarbons to produce aromatics, which have higher octane ratings. Intermediate products such as gasoils can even be reprocessed to break a heavy, long-chained oil into a lighter short-chained one, by various forms of cracking such as Fluid Catalytic Cracking, Thermal Cracking, and Hydro-cracking. The final step in gasoline production

is the blending of fuels with different octane ratings, vapour pressures, and other properties to meet product specification.

Table 2. Common Process Units in an Oil Refinery

Unit process	Function
Atmospheric Distillation Unit	Distills crude oil into fractions
Vacuum Distillation Unit	Further distills residual bottoms after atmospheric distillation
Hydro-treater Unit	desulfurizes naptha from atmospheric distillation, before sending to a Catalytic Reformer Unit
Catalytic Reformer Unit	reformate paraffins to aromatics, olefins, and cyclic hydrocarbons, which are having high octane number
Fluid Catalytic Cracking	break down heavier fractions into lighter, more valuable products – by means of catalytic system
Hydro-cracker Unit	break down heavier fractions into lighter, more valuable products – by means of steam
Alkylation Unit	produces high octane component by increasing branching or alkylation
Dimerization Unit	smaller olefinic molecules of less octane number are converted to molecules of higher octane number by dimerization of the smaller olefins
Isomerization Unit	straight chain normal alkanes of less octane number are isomerized to branched chain alkane of higher octane number

iii) Finishing – purification of the product streams

5.1. Details of Unit processes

5.1.1. Hydro-treater

A hydro-treater uses hydrogen to saturate aromatics and olefins as well as to remove undesirable compounds of elements such as sulfur and nitrogen.

Common major elements of a hydro-treater unit are a heater, a fixed-bed catalytic reactor and a hydrogen compressor. The catalyst promotes the reaction of the hydrogen with the sulfur compounds such as mercaptans to produce hydrogen sulfide, which is then usually bled off and treated with amine in an amine treater. The hydrogen also saturated hydrocarbon double bonds which helps raise the stability of the fuel.

5.1.2. Catalytic reforming

A catalytic reforming process converts a feed stream containing paraffins, olefins and naphthenes into aromatics to be used either as a motor fuel blending stock, or as a source for specific aromatic compounds, namely benzene, toluene and xylene for use in petrochemicals production. The product stream of the reformer is generally referred to as a reformat. Reformat produced by this process has a high octane rating. Significant quantities of hydrogen are also produced as byproduct. Catalytic reforming is normally facilitated by a bifunctional catalyst that is capable of rearranging and breaking long-chain hydrocarbons as well as removing hydrogen from naphthenes to produce aromatics. This process is different from steam reforming which is also a catalytic process that produces hydrogen as the main product.

5.1.3. Cracking

In an oil refinery cracking processes allow the production of light products (such as LPG and gasoline) from heavier crude oil distillation fractions (such as gas oils) and residues. Fluid Catalytic Cracking (FCC) produces a high yield of gasoline and LPG while Hydrocracking is a major source of jet fuel, gasoline components and LPG. Thermal cracking is currently used to upgrade very heavy fractions or to produce light fractions or distillates, burner fuel and/or petroleum coke. Two extremes of the thermal cracking in terms of product range are represented by the high-temperature process called steam cracking or pyrolysis (750-900 °C or more) which produces valuable ethylene and other feedstocks for the petrochemical industry, and the milder-temperature delayed coking (500 °C) which can produce, under the right conditions, valuable needle coke, a highly crystalline petroleum coke used in the production of electrodes for the steel and aluminum industries.

5.1.3.1. Fluid Catalytic Cracking

Initial process implementations were based on a low activity alumina catalyst and a reactor where the catalyst particles were suspended in rising flow of feed hydrocarbons in a fluidized bed. In newer designs, cracking takes place using a very active zeolite-based catalyst in a short-contact time vertical or upward sloped pipe called the “riser”. Pre-heated feed is sprayed into the base of the riser via feed nozzles where it contacts extremely hot fluidized catalyst at 665 to 760 °C. The hot catalyst vaporizes the feed and catalyzes the cracking reactions that break down the high molecular weight oil into lighter components including LPG, gasoline, and diesel. The catalyst-hydrocarbon mixture flows upward through the riser for just a few seconds and then the mixture is separated via cyclones. The catalyst-free hydrocarbons are routed to a main fractionator for separation into fuel gas, LPG, gasoline, light cycle oils used in diesel and jet fuel, and heavy fuel oil.

The catalytic cracking process involves the presence of acid catalysts (usually solid acids such as silica-alumina and zeolites) which promote a heterolytic (asymmetric) breakage of bonds yielding pairs of ions of opposite charges, usually a carbocation and the very unstable hydride anion.

During the trip up the riser, the cracking catalyst is “spent” by reactions which deposit coke on the catalyst and greatly reduce activity and selectivity. The “spent” catalyst is disengaged from the cracked hydrocarbon vapours and sent to a stripper where it is contacted with steam to remove hydrocarbons remaining in the catalyst pores. The “spent” catalyst then flows into a fluidized-bed regenerator where air (or in some cases air and oxygen) is used to burn off the coke to restore catalyst and also provide the necessary heat for the next reaction cycle, cracking being an endothermic reaction. The “regenerated” catalyst then flows to the base of the riser, repeating the cycle.

5.1.3.2. Hydrocracking

Hydrocracking is a catalytic cracking process assisted by the presence of an elevated partial pressure of hydrogen. The products of this process are saturated hydrocarbons; depending on the reaction conditions (temperature, pressure, catalyst activity) these products range from ethane, LPG to heavier hydrocarbons comprising mostly of isoparaffins. Hydrocracking is normally facilitated by a bifunctional catalyst that is

capable of rearranging and breaking hydrocarbon chains as well as adding hydrogen to aromatics and olefins to produce naphthenes and alkanes. Major products from hydrocracking are jet fuel, diesel, relatively high octane rating gasoline fractions and LPG. All these products have a very low content of sulfur and contaminants.

5.1.3.3. Steam Cracking

Steam cracking is a petrochemical process in which saturated hydrocarbons are broken down into smaller, often unsaturated, hydrocarbons. It is the principal industrial method for producing the lighter alkenes (commonly olefins), including ethane (ethylene) and propene (propylene).

In steam cracking, a gaseous or liquid hydrocarbon feed like naphtha, LPG or ethane is diluted with steam and then briefly heated in a furnace (obviously with out the presence of oxygen). Typically, the reaction temperature is very hot; around 850 °C, but the reaction is only allowed to take place very briefly. In modern cracking furnaces, the residence time is even reduced to milliseconds (resulting in gas velocities reaching speeds beyond the speed of sound) in order to improve the yield of desired products. After the cracking temperature has been reached, the gas is quickly quenched to stop the reaction in a transfer line exchanger.

The products produced in the reaction depend on the composition of the feed, the hydrocarbon to steam ratio and on the cracking temperature and furnace residence time. Light hydrocarbon feeds (such as ethane, LPGs or light naphthas) give product streams rich in the lighter alkenes, including ethylene, propylene, and butadiene. Heavier hydrocarbon (full range and heavy naphthas as well as other refinery products) feeds give some of these, but also give products rich in aromatic hydrocarbons and hydrocarbons suitable for inclusion in gasoline or fuel oil. The higher cracking temperature (also referred to as severity) favours the production of ethane and benzene, where as lower severity produces relatively higher amounts of propene, C4-hydrocarbons and liquid products.

The thermal cracking process follows a hemolytic mechanism, that is, bonds break symmetrically and thus pairs of free radicals are formed. The main reactions that take place include:

Initiation reactions, where a single molecule breaks apart into two free radicals. Only a small fraction of the feed molecules actually undergo initiation, but these reactions are necessary to produce the free radicals that drive the rest of the reactions. In steam cracking, initiation usually involves breaking a chemical bond between two carbon atoms, rather than the bond between a carbon and a hydrogen atom.

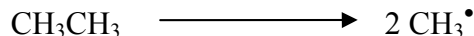

Hydrogen abstraction, where a free radical removes a hydrogen atom from another molecule, turning the second molecule into a free radical.

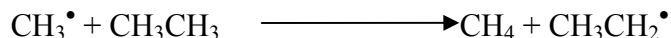

Radical decomposition, where a free radical breaks apart into two molecules, one an alkene, the other a free radical. This is the process that results in the alkene products of steam cracking.

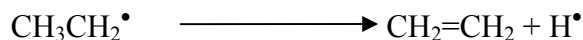

Radical addition, the reverse of radical decomposition, in which a radical reacts with an alkene to form a single, larger free radical. These processes are involved in forming the aromatic products that result when heavier feedstocks are used.

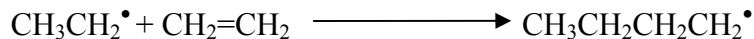

Termination reactions, which happen when two free radicals react with each other to produce products that are not free radicals. Two common forms of termination are recombination, where the two radicals combine to form one larger molecule, and *disproportionation*, where one radical transfers a hydrogen atom to the other, giving an alkene and an alkane.

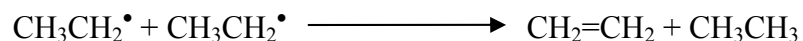
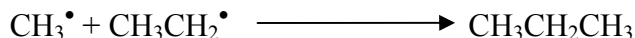

The process also results in the slow deposition of coke, a form of carbon, on the reactor walls. This degrades the effectiveness of the reactor, so reaction conditions are designed to minimize this. Nonetheless, a steam cracking furnace can usually only run for a few months at a time between de-cokings.

5.1.4. Alkylation

Alkylation is the transfer of an alkyl group from one molecule to another. The alkyl group may be transferred as a alkyl carbocation, a free radical or a carbanion.

In a standard oil refinery process, alkylation involves low-molecular-weight olefins (primarily a mixture of propylene and butylenes) with isobutene in the presence of a catalyst, either sulfuric acid or hydrofluoric acid. The product is called alkylate and is composed of a mixture of high-octane, branched-chain paraffin hydrocarbons. Alkylate is a premium gasoline blending stock because it has exceptional antiknock properties and is clean burning.

Most crude oils contain only 10 to 40 percent of their hydrocarbon constituents in the gasoline range, so refineries use cracking processes, which convert high molecular weight hydrocarbons into smaller and more volatile compounds. Polymerization converts small gaseous olefins into liquid gasoline-size hydrocarbons. Alkylation processes transform small olefin and iso-paraffin molecules into larger iso-paraffins with a high octane number. Combining cracking, polymerization, and alkylation can result in a gasoline yield representing 70 percent of the starting crude oil.

5.1.5. Isomerization

Isomerization is a process by which straight chain alkanes are converted to branched chain alkanes that can be blended in petrol to improve its octane rating (in presence of finely dispersed platinum on aluminium oxide catalyst).

6. Products of oil refinery

6.1. Asphalt

The term asphalt is often used as an abbreviation for asphalt concrete. Asphalt is a sticky, black and highly viscous liquid or semi-solid that is present in most crude petroleum and in some natural deposits. Asphalt is composed almost entirely of bitumen. Asphalt is sometimes confused with tar, which is an artificial material produced by the destructive distillation of organic matter. Tar is also predominantly composed of bitumen; however the bitumen content of tar is typically lower than that of asphalt. Tar and asphalt have different engineering properties.

Asphalt can be separated from the other components in crude oil (such as naphtha, gasoline and diesel) by the process of fractional distillation, usually under vacuum conditions. A better separation can be achieved by further processing of the heavier fraction of the crude oil in a de-asphalting unit which uses either propane or butane in a process which is possible by “blowing” the product: namely reacting it with oxygen. This

makes the product harder and more viscous. Asphalt is rather hard to transport in bulk (it hardens unless kept very hot). So it is sometimes mixed with diesel oil or kerosene before shipping. Upon delivery, these lighter materials are separated out of the mixture. This mixture is often called bitumen feedstock, or BFS.

The largest use of asphalt is for making asphalt concrete for pavements. Roofing shingles account for most of the remaining asphalt consumption. Other uses include cattle sprays, fence post treatments, and waterproofing for fabrics. The ancient middle-east natural asphalt deposits were used for mortar between bricks and stones, ship caulk, and waterproofing.

6.2. Diesel Fuel

Petroleum derived diesel is composed of about 75% saturated hydrocarbons (primarily paraffins including n, iso, and cycloparaffins), and 25% aromatic hydrocarbons (including naphthalens and alkylbenzenes). The average chemical formula for common diesel fuel is $C_{12}H_{26}$, ranging from approximately, $C_{10}H_{22}$ to $C_{15}H_{32}$.

Diesel is produced from petroleum, and is sometimes called petrodiesel when there is a need to distinguish it from diesel obtained from other sources. As a hydrocarbon mixture, it is obtained in the fractional distillation of crude oil between 250 °C and 350 °C at atmospheric pressure.

petro-diesel is considered to be a fuel oil and is about 18% denser than gasoline. The density of diesel is about 850 grams per liter whereas gasoline has a density of about 720 g/l, or about 18% less. Diesel is generally simpler to refine than gasoline and often costs less.

Diesel fuel, however, often contains higher quantities of sulfur. High levels of sulfur in diesel are harmful for the environment. It prevents the use of catalytic diesel particulate filters to control diesel particulate emissions, as well as more advanced technologies such as nitrogen oxide (NOx) absorbers, to reduce emission. However, lowering sulfur also reduces the lubricity of the fuel, meaning that additives must be put into the fuel to help lubricate engines. Biodiesel is an effective lubricant. Diesel contains approximately 18% more energy per unit of volume than gasoline, which, along with the greater efficiency of diesel engines, contributes to fuel economy.

Synthetic diesel

Wood, straw, corn, garbage, and sewage-sludge may be dried and gasified. After purification, Fischer Tropsch process is used to produce synthetic diesel. Other attempts use enzymatic processes and are also economic in case of high oil prices.

Biodiesel

Biodiesel can be obtained from vegetable oil and animal fats (bio-lipids, using transesterification). Biodiesel is a non-fossil fuel alternative to petrodiesel. There have been reports that a diesel-biodiesel mix results in lower emissions that either can achieve alone. A small percentage of biodiesel can be used as an additive in low-sulfur formulations of diesel to increase the lubricity lost when the sulfur is removed.

Chemically, most biodiesel consists of alkyl (usually methyl) esters instead of the alkanes and aromatic hydrocarbons of petroleum derived diesel. However, biodiesel has combustion properties very similar to petrodiesel, including combustion energy and cetane ratings. Paraffin biodiesel also exists. Due to the purity of the source, it has a higher quality than petrodiesel.

6.3. Fuel Oil

Fuel oil is a fraction obtained from petroleum distillation, either as a distillate or a residue. Broadly speaking, fuel oil is any liquid petroleum product that is burned in a furnace for the generation of heat or used in an engine for the generation of power. Fuel oil is made of long hydrocarbon chains, particularly alkanes, cycloalkanes and aromatics. Factually and in a stricter sense, the term fuel oil is used to indicate the heaviest commercial fuel that can be obtained from crude oil, heavier than gasoline and naphtha. Fuel oil is classified into six classes, according to its boiling temperature, composition and purpose. The boiling point ranges from 175 to 600 C, and carbon chain length, 20 to 70 atoms. These are mainly used in ships with varying blending proportions.

6.4. Gasoline

Gasoline (or petrol) is a petroleum-derived liquid mixture consisting primarily of hydrocarbons, used as fuel in internal combustion engines. Gasoline is separated from crude oil via distillation, called natural gasoline, will not meet the required specifications for modern engines (in particular octane rating), but these streams will form of the blend.

The bulk of a typical gasoline consists of hydrocarbons between 5 to 12 carbon atoms per molecule.

The various refinery streams produce gasoline of different characteristics. Some important streams are:

- Reformate, produced in a catalytic reformer with a high octane and high aromatics content, and very low olefins (alkenes).
- Catalytically Cracked Gasoline or Catalytically Cracked Naphtha, produced from a catalytic cracker, with a moderate octane, high olefins (alkene) content, and moderate aromatics level.
- Product from a hydrocracker, contains medium to low octane and moderate aromatic levels.
- Natural Gasoline, directly from crude oil contains low octane, low aromatics (depending on the crude oil), some naphthenes (cycloalkanes) and zero olefins (alkenes).
- Alkylate, produced in an alkylation unit, with a high octane and which is pure paraffin (alkane), mainly branched chains.
- Isomerate, which is made by isomerising natural gasoline to increase its octane rating and is very low in aromatics and benzene content.

Overall a typical gasoline is predominantly a mixture of paraffins (alkanes), naphthenes (cycloalkanes), aromatics and olefins (alkenes). The exact ratios can depend on

- The oil refinery that makes the gasoline, as not all refineries have the same set of processing units.
- The crude oil used by the refinery on a particular day.
- The grade of gasoline, in particular the octane.

6.4.1. Octane rating

Octane number is a figure of merit representing the resistance of gasoline to premature detonation when exposed to heat and pressure in the combustion chamber of an internal combustion engine. Such detonation is wasteful of the energy in the fuel and potentially damaging to the engine; premature detonation is indicated by knocking or ringing noises that occur as the engine operates. If an engine running on a particular gasoline makes such noises, they can be lessened or eliminated by using a gasoline with a higher octane

number. The octane number of a sample of fuel is determined by burning the gasoline in an engine under controlled conditions, e.g., of spark timing, compression, engine speed, and load, until a standard level of knock occurs. The engine is next operated on a fuel blended from a form of isooctane (octane number 100) that is very resistant to knocking and a form of heptane (octane number 0) that knocks very easily. When a blend is found that duplicates the knocking intensity of the sample under test, the percentage of isooctane by volume in the blended sample is taken as the octane number of the fuel. Octane numbers higher than 100 are determined by measuring the amount of tetraethyl lead that must be added to pure isooctane so as to duplicate the knocking of a sample fuel. Factors which can increase the octane number are more branching: 2-methylbutane is less likely to autoignite than pentane. Shorter chains: pentane is less likely to autoignite than heptane.

6.4.2. Additives to gasoline for value addition

Additives have been added to increase the value addition of gasoline either octane number or combustion capacity.

6.4.2.1. To increase octane number

The discovery that lead additives reduced the knocking property of gasoline in internal combustion engine led to the widespread adoption of the practice in the 1920s and therefore more powerful higher compression engines. The most popular additive was **tetra-ethyl lead**. However, with the recognition of the environmental damage caused by lead, and the incompatibility of lead with catalytic converters found on virtually all automobiles since 1975, this practice began to wane in the 1980s. Most countries are phasing out leaded fuel; different additives have replaced the lead compounds. The most popular additives include **aromatic hydrocarbons**, **ethers** and **alcohol** (usually **ethanol** or **methanol**).

6.4.2.2. To increase combustion capacity

Oxygenate blending increases oxygen to the fuel in oxygen-bearing compounds such as MTBE, ethanol and ETBE, and so reduces the amount of carbon monoxide and unburned fuel in the exhaust gas, thus reducing smog. MTBE use is being phased out in some countries due to issues with contamination of ground water. Ethanol and to a lesser extent the ethanol derived ETBE are a common replacements. Especially ethanol

derived from bio-matter such as corn, sugar cane or grain is frequent, this will often be referred to as bio-ethanol. An ethanol-gasoline mix of 10% ethanol mixed with gasoline is called gasohol.

6.4.3. Energy content

Gasoline contains about 45 mega joules per kilogram (MJ/kg) or 135 MJ/US gallon. A high octane fuel such as LPG has lower energy content than lower octane gasoline, resulting in an overall lower power output at the regular compression ratio of an engine that runs on gasoline. However, with an engine tuned to the use of LPG (i.e., via higher compression ratios such as 12:1 instead of 8:1), this lower power output can be overcome. This is because higher – Octane fuels allow for higher compression ratio.

Volumetric energy density of some fuels compared to gasoline is given in Table 4.

Table 4. Energy content of different fuels obtained from petroleum

Fuel type	MJ/L	MJ/kg
Gasoline	29.0	45
LPG	22.16	34.39
Ethanol	19.59	30.40
Methanol	14.57	22.61
Gasohol (10% ethanol + 90 % gasoline)	28.06	43.54
Diesel	40.9	63.47

6.5. Kerosene

Kerosene is a colourless flammable hydrocarbon liquid. Kerosene is obtained from the fractional distillation of petroleum at 150 C and 275 C (carbon chains from C12 to C15 range). Typically, kerosene directly distilled from crude oil requires some treatment in an hydro-treater, to reduce its sulfur content.

At one time it was widely used in kerosene lamps but it is now mainly used in aviation fuel for jet engines. A form of kerosene known as RP-1 is burnt with liquid oxygen as rocket fuel. Its use as a cooking fuel is mostly restricted to some portable stoves in less developed countries, where it is usually less refined and contains impurities and even debris. It can also be used to remove lice from hair, but stings and can be dangerous on

skin. Most of these uses of kerosene created thick black smoke because of the low temperature of combustion. It is also used as an organic solvent.

6.6. Liquefied petroleum gas

LPG is manufactured during the refining of crude oil, or extracted from oil or gas streams as they emerge from the ground. Liquefied petroleum gas (also called liquefied petroleum gas, liquid petroleum gas, LPG, LP Gas, or auto gas) is a mixture of hydrocarbon gases used as a fuel in cooking, heating appliances, vehicles, and increasingly replacing fluorocarbons as an aerosol propellant and a refrigerant to reduce damage to the ozone layer. Varieties of LPG bought and sold include mixes that are primarily propane, mixes that are primarily butane, and mixes including both propane and butane, depending on the season. Propylene and butylenes are usually also present in small concentrations. A powerful odorant, ethanethiol, is added so that leaks can be detected easily.

At normal temperatures and pressures, LPG will evaporate. Because of this, LPG is supplied in pressurized steel bottles. In order to allow for thermal expansion of the contained liquid, these bottles should not be filled completely; typically, they are filled to between 80% and 85% of their capacity.

6.7. Lubricant

A lubricant is introduced between two moving surfaces to reduce the friction and wear between them. A lubricant provides a protective film which allows for two touching surfaces to be separated, thus lessening the friction between them.

Typically lubricants contain 90% base oil (most often petroleum fractions, called mineral oils) and less than 10% additives. Vegetable oils or synthetic liquids such as hydrogenated polyolefins, esters, silicone, fluorocarbons and many others are sometimes used as base oils. Additives deliver reduced friction and wear, increased viscosity, resistance to corrosion and oxidation, aging or contamination.

In developed nations, lubricants contribute to nearly $\frac{1}{4}$ of total pollution released to environment. Spent lubricants are referred to as used oil or waste oil. As a liquid waste, one liter of used oil can contaminate one million liters of water.

6.8. Paraffin

Paraffin is a common name for a group of high molecular weight alkane hydrocarbons with the general formula C_nH_{2n+2} , where n is greater than about 20. It is also called as paraffin wax. Paraffin is also a technical name for an alkane in general, but in most cases it refers specifically to a linear, or normal alkane, while branched, or isoalkanes are also called isoparaffins.

It is mostly found as a white, odourless, tasteless, waxy solid, with a typical melting point between about 47 °C to 65 °C. It is insoluble in water, but soluble in ether, benzene, and certain esters. Paraffin is unaffected by most common chemical reagents, but burns readily.

Liquid paraffin has a number of names, including nujol, mineral spirits, adepsine oil, alboline, glymol, liquid paraffin oil, saxol, or USP mineral oil. It is often used in infrared spectroscopy, as it has a relatively uncomplicated IR spectrum.

Paraffin is used in

- Candle making
- Coatings for waxed paper or cloth
- Coatings for many kinds of hard cheese
- As anticaking, moisture repellent and dust binding coatings for fertilizers
- Preparing specimens for histology
- Solid propellant for hybrid rockets
- Sealing jars, cans, and bottles
- In dermatology, as an emollient (moisturizer)
- Surfing, for grip on surfboards as a component of surfwax
- The primary component of glide wax, used on skis and snowboards
- As a food additive
- Used in forensics to detect granules of gunpowder in the hand of a shooting suspect
- Food-grade paraffin wax is used in some candies to make them look shiny
- Impure mixtures of mostly paraffin wax are used in wax baths for beauty and therapy purposes

6.9. Mineral Oil

Mineral oil is a by-product in the distillation of petroleum to produce gasoline. It is chemically-inert transparent colourless oil composed mainly of alkanes and cyclic paraffins, related to white petroleum. Mineral oil is a substance of relatively low value, and is produced in a very large quantities. Mineral oil is available in light and heavy grades, and can often be found in drug stores. It is used in the following:

- Refined mineral oil is used as transformer oil
- Mineral oil is used to store and transport alkali metals. The oil prevents the metals from reacting with atmospheric moisture.
- Personal care
- Mineral oil is sometimes taken orally as a laxative. It works by lubricating feces and the intestinal mucus membranes
- Mineral oil with added fragrance is marketed as ‘baby oil’ in the US and UK
- Used as an ingredient in baby lotions, cold creams, ointments and other pharmaceuticals and cosmetics
- Can also be used for eyelashes; can generally be used to prevent brittleness and/or breaking of lashes
- Lubrication
- Coolant
- Low viscosity mineral oil is old as a preservative for wooden cutting boards and utensils
- A coating of mineral oil is excellent at protecting metal surfaces from moisture and oxidation
- Food-preparation butcher block surfaces are often conditioned periodically with mineral oil
- Light mineral oil is used in textile industries and used as a jute batching oil
- Mineral oil is used as a sealer for soapstone countertops
- Sometimes used in the food industry (particularly for candies)
- Used as a cleaner and solvent for inks in fine art printmaking

6.10. Tar

Tar is viscous black liquid derived from the destructive distillation of organic matter. Most tar is produced from coal as a byproduct of coke production, but it can also be produced from petroleum, peat or wood. The use of the word “tar” is frequently a misnomer. Naturally occurring “tar pits” actually contain asphalt, not tar, and are more accurately called as asphalt pits. Tar sand deposits contain bitumen rather than tar.

Tar, of which surprisingly petroleum tar is the most effective, is used in treatment of psoriasis. Tar is a disinfectant substance, and is used as such. Petroleum tar was also used in ancient Egyptian mummification circa 1000 BC.

Tar was a vital component of the first sealed, or “tarmac”, roads. It was also used as seal for roofing shingles and to seal the hulls of ships and boats. It was also used to waterproof sails, but today sails made from naturally waterproof synthetic substances have negated the need for sail sealing.

Wood tar is still used to seal traditional wooden boats and the roofs of historical shingle roofed churches. Wood tar is also available diluted as tar water, which has numerous uses:

- Flavoring for candies and alcohol
- Scent for saunas
- Anti-dandruff agent in shampoo
- As a component of cosmetics

6.11. Bitumen

Bitumen is a category of organic liquids that are highly viscous, black, sticky and wholly soluble in carbon disulfide. Asphalt and tar are the most common forms of bitumen.

Bitumen in the form of asphalt is obtained by fractional distillation of crude oil. Bitumen being the heaviest and being the fraction with the highest boiling point, it appears as the bottommost fraction. Bitumen in the form of tar is obtained by the destructive distillation of organic matter, usually bituminous coal.

Bitumen is primarily used for paving roads. It is also the prime feed stock for petroleum production from tar sands currently under development in Alberta, Canada. In the past, bitumen was used to waterproof boats, and even as a coating for buildings, for example,

that the city of Carthage was easily burnt down due to extensive use of bitumen in construction.

Most geologists believe that naturally occurring deposits of bitumen are formed from the remains of ancient, microscopic algae and other once-living things. These organisms died and their remains were deposited in the mud on the bottom of the ocean or lake where they lived. Under the heat and pressure of burial deep in the earth, the remains were transformed into materials such as bitumen, kerogen, or petroleum. A minority of geologists, proponents of the theory of abiogenic petroleum origin, believe that bitumen and other hydrocarbons heavier than methane originally derive from deep inside the mantle of the earth rather than biological detritus.

6.12. Pitch (resin)

Pitch is the name for any of a number of highly viscous liquids which appear solid. Pitch can be made from petroleum products or plants. **Petroleum-derived pitch** is also called bitumen. **Pitch produced from plants** is also known as **resin** or rosin.

Tar pitch appears solid, and can be shattered with a hard impact, but it is actually a liquid. Pitch flows at room temperature, but extremely slowly. Pitch has a viscosity approximately 100 billion (10^{11}) times that of water.

Pitch was traditionally used to help caulk the seams of wooden sailing vessels. It was heated, put into a container with a very long spout. The word pitcher is said to derive from this long spouted container used to pour hot pitch.

7. Petrochemicals

According to crude oil composition and demand, refineries can produce different shares of petroleum products. Largest share of oil products is used as energy carriers: various grades of fuel oil and gasoline. Refineries also produce other chemicals, some of which are used in chemical processes to produce plastics and other useful materials. Since petroleum often contains a couple of percent sulfur, large quantities of sulfur are also often produced as a petroleum product. Carbon and hydrogen may also be produced as petroleum products. The hydrogen produced is often used as an intermediate product for other oil refinery processes such as hydrocracking and hydrodesulfurization.

A petrochemical is any chemical derived from fossil fuels. These include purified fossil fuels such as methane, propane, butane, gasoline, kerosene, diesel fuel, aviation fuel, or

fuel oil and also include many agricultural chemicals such as pesticides, herbicides and fertilizers, and other items such as plastics, asphalt and synthetic fibers. Also a wide variety of industrial chemicals are petrochemicals. As petroleum products are feed stocks for many industries, frequently chemical plants are sited adjacent to a refinery, utilizing intermediate products of the refinery as feed stocks for the production of specialized materials such as plastics or agrochemicals.

Table 5. Partial list of major commercial petrochemicals derived from petroleum sources

Ethylene	Poly ethylene		
	Ethylene oxide	Ethylene glycols	Poly esters Engine coolant
		Glycol esters	
		ethoxylates	
	Vinyl acetate		
	1,2 Dichloroethane	Trichloroethylene	
		Tetrachloroethylene	
		Vinyl chloride	Polyvinyl chloride
	Ethyl benzene	styrene	Poly styrene
			Synthetic rubbers
	Higher olefins	Detergent alcohols	
Propylene	cumene	Acetone	
		Bisphenol A	Epoxy resins
			Poly carbonate
		Solvents	
	Isopropyl alcohol		
	Acrylonitrile		
	Polypropylene		
	Propylene oxide	Propylene glycol	
		Glycol esters	
	Acrylic acid	Allyl chloride	Epichlorohydrin
			Epoxyresins

Butadiene	Synthetic rubbers		
Benzene	Ethyl benzene	Styrene	Polystyrene
			Synthetic rubber
	Cumene	Phenol	
		Bisphenol A	Epoxy resins
			Polycarbonate
	cyclohexane	Adipic acid	Nylons
		caprolactam	Nylons
	Nitrobenzene	aniline	Methylene diphenyl Diisocyanate (MDI)
			Poly urethanes
	Alkyl benzene	Detergents	
	Chlorobenzene		
Toluene	Benzene		
	Toluene isocyanate	Polyurethanes	
	Benzoic acid	caprolactam	Nylon
Mixed xylenes	Ortho xylene	Phthalic anhydride	
	Para xylene	Dimethyl terethalate	Poly esters
		Purified terephthalic acid	Poly esters

8. Remarks

As has been seen, petroleum serves as an extensive source for the energy need as well as feed stock for the spectrum of industries. Petroleum is a non-renewable natural resource and the industry is faced with the inevitable eventual depletion of the world's oil supply. By the very definition of non-renewable resources, oil exploration alone will not save off future shortages of the resource. Resource economists argue that oil prices will rise as demand increases relative to supply, and that this will spur further exploration and development. However, this process will not increase the amount of oil in the ground, but will rather temporarily prolong production as higher prices make it economical to extent oil that was previously not economically recoverable.

References

1. R. Narayan and B. Viswanathan, 'Chemical and Electrochemical Energy Systems', University Press, 1998.
2. <http://en.wikipedia.org/wiki/Petro>

Chapter – 3

NATURAL GAS

V. Chidambaram

1. Introduction

Natural gas has emerged as promising fuel due to its environment friendly nature, efficiency, and cost effectiveness. Natural gas is considered to be most eco-friendly fuel based on available information. Economically natural gas is more efficient since only 10 % of the produced gas wasted before consumption and it does not need to be generated from other fuels. Moreover natural gas is used in its normal state. Natural gas has high heat content of about 1000 to 11000 Btu per Scf for pipeline quality gas and it has high flame temperature. Natural gas is easy to handle and convenient to use and energy equivalent basis, it has been price controlled below its competitor oil. It is also suitable chemical feedstock for petrochemical industry. Hence natural gas can substitute oil in both sectors namely fuels (industry and domestic) and chemicals (fertilizer petrochemicals and organic chemicals).

2. Natural gas occurrence and production

Natural gas was formed from the remains of tiny sea animals and plants that died 200-400 million years ago. The ancient people of Greece, Persia, and India discovered natural gas many centuries ago.

Table 1. Time line for natural gas history in recent times

Year	Natural gas usage
1816	First used in America to illuminate Baltimore
1821	William Hart dug the first successful American natural gas well in Fredonia, New York
1858	Fredonia Gas Light Company opened its doors in 1858 as the nation's first natural gas company
1900	natural gas had been discovered in 17 states
Present	Today, natural gas accounts for about a quarter of the energy we use.

About 2,500 years ago, the Chinese recognized that natural gas could be put to work. The Chinese piped the gas from shallow wells and burnt it under large pans to evaporate sea water for salt.

3. Sources of Natural Gas

Natural gas can be hard to find since it can be trapped in porous rocks deep underground. However, various methods have been developed to find out natural gas deposits. The methods employed are as follows:

- 1) Looking at surface rocks to find clues about underground formations,
- 2) Setting off small explosions or drop heavy weights on the surface and record the sound waves as they bounce back from the rock layers underground and
- 3) By measuring the gravitational pull of rock masses deep within the earth.

Scientists are also researching new ways to obtain natural (methane) gas from biomass as a fuel source derived from plant and animal wastes. Methane gas is naturally produced whenever organic matter decays. Coal beds and landfills are other sources of natural gas, however only 3 % of the demand is achieved.

Table 2. Production of Natural gas in 2000

Country /countries	Percentage of production to total production
Russian Federation	22.5
Canada, United Kingdom, Algeria, Indonesia, Iran, Netherlands, Norway and Uzbekistan.	Other major production
United States	22.9 %

Natural gas resources are widely distributed around the globe. It is estimated that a significant amount of natural gas remains to be discovered.

World largest reserves are held by former Soviet Union of about 38 % of total reserves and Middle East holds about 35 %.

Table 3. Distribution of proved natural gas reserves (%) in 2004

Country	Reserves %
North America	4
Russian Federation	27
Middle East	40
Other Europe and Asia	9
Asia Pacific	8
South and central America	4
Africa	8

Table 4. Reserves and Resources of Natural Gas

Resources	Reserves
Natural gas resources include all the deposits of gas that are still in the ground waiting to be tapped	Natural gas reserves are only those gas deposits that scientists know, or strongly believe, can be recovered given today's prices and drilling technology

4. Physical properties of Natural gas

Natural gas is a mixture of light hydrocarbons including methane, ethane, propane, butanes and pentanes. Other compounds found in natural gas include CO₂, helium, hydrogen sulphide and nitrogen. The composition of natural gas is never constant, however, the primary component of natural gas is methane (typically, at least 90%). Methane is highly flammable, burns easily and almost completely. It emits very little air pollution. Natural gas is neither corrosive nor toxic, its ignition temperature is high, and it has a narrow flammability range, making it an inherently safe fossil fuel compared to other fuel sources. In addition, because of its specific gravity (0.60), lower than that of air (1.00), natural gas rises if escaping, thus dissipating from the site of any leak.

5. Classification of Natural Gas

In terms of occurrence, natural gas is classified as non-associated gas, associated gas, dissolved gas and gas cap.

5.1. Non-associated gas

There is non-associated natural gas which is found in reservoirs in which there is no or, at best, minimum amounts of crude oil. Non-associated gas is usually richer in methane but is markedly leaner in terms of the higher paraffinic hydrocarbons and condensate material. Non-associated gas, unlike associated gas could be kept underground as long as required. This is therefore discretionary gas to be tapped on the economical and technological compulsions.

5.2. Associated gas

Natural gas found in crude oil reservoirs and produced during the production of crude oil is called associated gas. It exists as a free gas (gas cap) in contact with the crude petroleum and also as a 'dissolved natural gas' in the crude oil. Associated gas is usually leaner in methane than the non-associated gas but will be richer in the higher molecular weight hydrocarbons. Non-associated gas can be produced at higher pressures whereas associated gas (free or dissolved gas) must be separated from petroleum at lower separator pressures, which usually involves increased expenditure for compression.

5.3. Classification Based on Gas Composition

Table 5. Classification of Natural Gas Composition

Classification based on composition	Components
lean gas	Methane
wet gas	considerable amounts of the higher molecular weight hydrocarbons
sour gas	hydrogen sulphide;
sweet gas	little, if any, hydrogen sulphide;
residue gas	natural gas from which the higher molecular weight hydrocarbons have been extracted
casing head gas	Derived from petroleum but is separated at the separation facility at the well head.

6. Natural Gas Products

Natural gas and/or its constituent hydrocarbons are marketed in the form of different products, such as lean natural gas, wet natural gas (liquefied natural gas (LPG)) compressed natural gas (CNG), natural gas liquids (NGL), liquefied petroleum gas (LPG), natural gasoline, natural gas condensate, ethane, propane, ethane-propane fraction and butanes.

6.1. Natural Gas Liquids

Natural gas liquids (NGL) are ethane, propane, and ethane-propane fraction, liquefied petroleum gas (LPG) and natural gasoline. There are also standards for the natural gas liquids that are usually set by mutual agreement between the buyer and the seller, but such specifications do vary widely and can only be given approximate limits. For example, ethane may have a maximum methane content of 1.58% by volume and maximum carbon dioxide content of 0.28% by volume. On the other hand, propane will be specified to have a maximum of 95% propane by volume, a maximum of 1-2% butane and a maximum vapour pressure which limits ethane content. For butane, the percentage of one of the butane isomers is usually specified along with the maximum amounts of propane and pentane.

Other properties that may be specified are vapour pressure, specific gravity, corrosivity, dryness and sulphur content. The specifications for the propane-butane mixtures will have limits on the amount of the non-hydrocarbons and in addition, the maximum isopentane content is usually stated.

The liquefied petroleum gas (LPG) is usually composed of propane, butanes and/or mixtures thereof, small amounts of ethane and pentane may also be present as impurities. On the other hand, the natural gasoline (like refinery gasoline) consists of mostly pentane and higher molecular weight hydrocarbons. The term 'natural gasoline' has also been applied to mixture of liquefied petroleum gas, pentanes and higher molecular weight hydrocarbons. Natural gasoline may be sold on the basis of vapour pressure or on the basis of actual composition which is determined from the Reid vapour pressure (RVP) composition curves prepared for each product source (ASTM D323).

6.2. Natural Gas Processing

Natural gas produced at the well contains contaminants and natural gas liquids which have to be removed before sending to the consumers. These contaminants can cause the operation problem, pipe rupture or pipe deterioration.

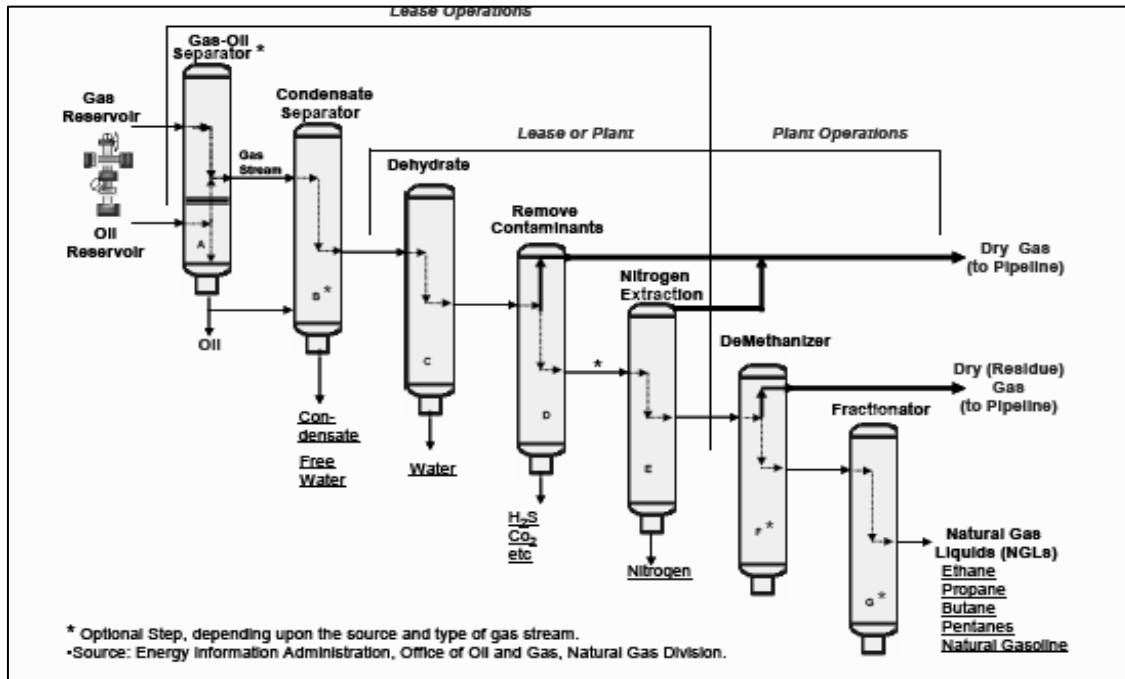

Scheme 1. Natural gas processing

6.3. Natural Gas Chain

Exploration: Geologists now play a central role in identifying natural gas formations. They evaluate the structure of the soil and compare it with other areas where natural gas has been found. Later, they carry out specific tests as studying above ground rock formations where natural gas traps may have been formed. The more accurate these techniques get the higher the probability of finding gas when drilling.

Extraction: Natural gas is captured by drilling a hole into the reservoir rock. Drilling can be onshore or offshore. Equipment used for drilling depends on the location of the natural gas trap and the nature of the rock. Once natural gas has been found it has to be recovered efficiently. The most efficient recovery rate is characterized by the maximum quantity of gas that can be extracted during a period of time without damaging the formation. Several

tests must be taken at this stage. Most often, the natural gas is under pressure and will come out of the hole on its own. In some cases, pumps and other more complicated procedures are required to remove the natural gas from the ground.

Processing: Processing has been carried out to remove contaminants from the natural gas and also to convert it into useful energy for its different applications. This processing involves first the extraction of the natural gas liquids from the natural gas stream and then the fractioning of the natural gas liquids into their separate components.

7. Transportation

Natural gas reaching the consumers ends normally through pipeline which is normally made of steel piping and measure between 20 and 42 inches of diameter. Since gas is moved at high pressures, there are compressor stations along the pipeline in order to maintain the level of pressure needed. Compared to other energy sources, natural gas transportation is very efficient because the portion of energy lost from origin to destination is low.

7.1. Transported as LNG

Natural gas can also be transported by sea. In this case, it is transformed into liquefied natural gas (LNG). The liquefaction process removes oxygen, carbon dioxide, sulphur compounds and water. A full LNG chain consists of a liquefaction plant, low temperature and pressurized transport ships and a regasification terminal.

7.2. Sector wise exploitation of Natural Gas

7.2.1. Residential usage

Natural gas is used in cooking, washing drying, water warming and air conditioning. Operating costs of natural gas equipment are generally lower than those of other energy sources.

7.2.2. Commercial use: The flow diagram for commercial use is shown in Scheme.2.

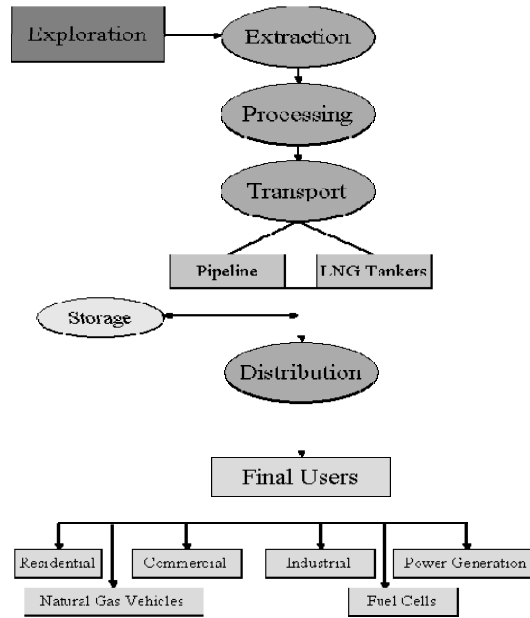

Scheme 2. Natural gas Chain

7.2.3. Industrial utilization of Natural gas

Manufacture of pulp and paper, metals, chemicals, stone, clay, glass, and to process certain foods are various fields in which natural gas is effectively utilized. Gas is also used to treat waste materials, for incineration, drying, dehumidification, heating and cooling, and CO generation. It is also a suitable chemical feedstock for the petrochemical industry. Natural gas has a multitude of industrial uses, including providing the base ingredients for such varied products as plastic, fertilizer, anti-freeze, and fabrics. In fact, industry is the largest consumer of natural gas, accounting for 43 percent of natural gas use across all sectors. Natural gas is the second most used energy source in industry, trailing behind only electricity. Lighting is the main use of energy in the industrial sector, which accounts for the tremendous electricity requirements of this sector. The graph below shows current as well as projected energy consumption by fuel in the industrial sector.

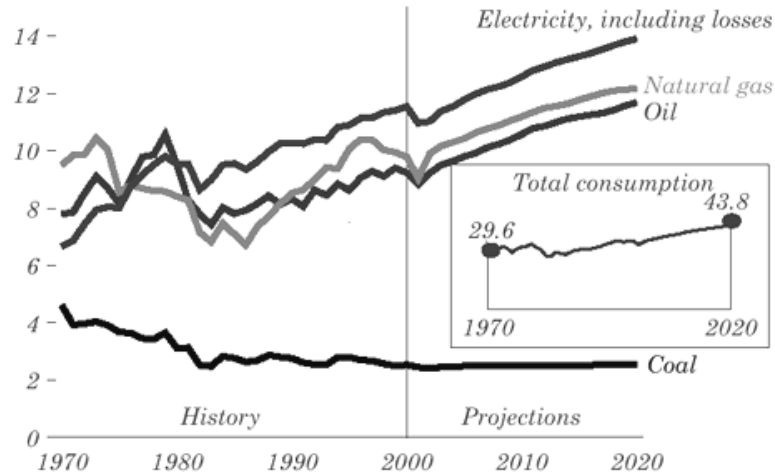

Fig.1. Industrial primary energy consumption by Fuel 1970-2020

(Source: EIA Annual Energy Outlook 2002 with Projections to 2020)

Natural gas as a feedstock is commonly found as a building block for methanol, which in turn has many industrial applications. Natural gas is converted to what is known as synthesis gas, which is a mixture of hydrogen and carbon oxides formed through a process known as steam reforming. In this process, natural gas is exposed to a catalyst that causes oxidization of the natural gas when brought into contact with steam. This synthesis gas, once formed, may be used to produce methanol (or Methyl Alcohol), which in turn is used to produce such substances as formaldehyde, acetic acid, and MTBE (methyl tertiary butyl ether) that is used as an additive for cleaner burning gasoline. Methanol may also be used as a fuel source in fuel cells.

7.2.4. Power generation

Natural gas works more efficiently and emits less pollution than other fossil fuel power plants. Due to economic, environmental, and technological changes, natural gas has become the fuel of choice for new power plants. In fact, in 2000, 23,453 MW (megawatts) of new electric capacity was added in the U.S. Of this, almost 95 percent, or 22,238 MW were natural gas fired additions. The graph below shows how, according to the energy information administration (EIA), natural gas fired electricity generation is expected to increase dramatically over the next 20 years, as all of the new capacity that is currently being constructed comes online.

Steam generation units, centralized gas turbines, micro turbines, combined cycle units and distributed generation are the other examples where natural gas is utilized.

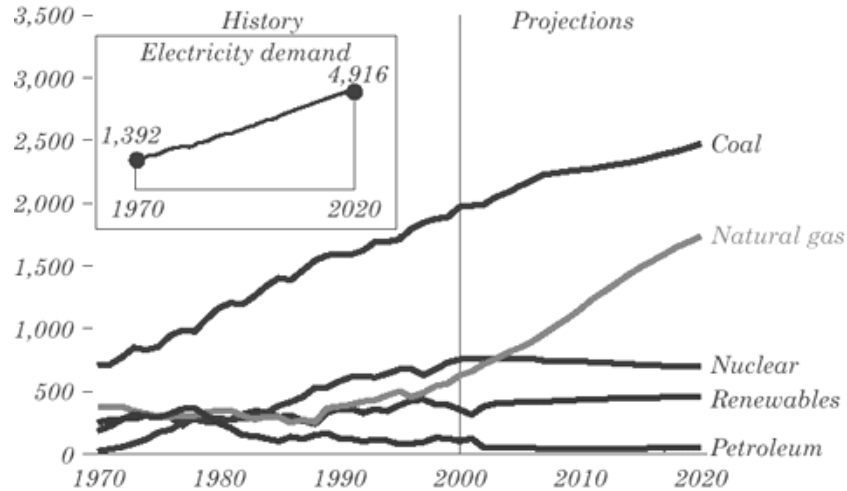

Fig. 2. Electricity Generation by Fuel 1970-2020 (billion kilowatt hours)

7.2.5. Transportation

Natural gas can be used as a motor vehicle fuel in two ways: as compressed natural gas (CNG), which is the most common form, and as liquefied natural gas. Cars using natural gas are estimated to emit 20% less greenhouse gases than gasoline or diesel cars. In many countries NGVs are introduced to replace buses, taxis and other public vehicle fleets. Natural gas in vehicles is inexpensive and convenient.

Most natural gas vehicles operate using compressed natural gas (CNG). This compressed gas is stored in similar fashion to a car's gasoline tank, attached to the rear, top, or undercarriage of the vehicle in a tube shaped storage tank. A CNG tank can be filled in a similar manner, and in a similar amount of time, to a gasoline tank.

Fuel cells: Natural gas is one of the multiple fuels on which fuel cells can operate. Fuel cells are becoming an increasingly important technology for the generation of electricity. They are like rechargeable batteries, except instead of using an electric recharger; they use a fuel, such as natural gas, to generate electric power even when they are in use. Fuel cells for distributed generation systems offer a multitude of benefits, and are an exciting area of innovation and research for distributed generation applications. One of the major

technological innovations with regard to electric generation, whether distributed or centralized, is the use of Combined Heat and Power (CHP) systems. These systems make use of heat that is normally wasted in the electric generation process, thereby increasing the energy efficiency of the total system

8. Chemicals from natural gas: Natural gas a Feed stock for production of value added products/ Chemicals

Table 6 Methane as chemical feedstock

Product	Reaction	Conditions
Synthesis gas	$\text{CH}_4 + \text{H}_2\text{O} \rightarrow \text{CO} + 3\text{H}_2$	P: 30-50 bar T: 1123 K Ni-supported catalyst
Hydrocyanic acid HCN	$\text{CH}_4 + \text{NH}_3 \rightarrow \text{HCN} + 3\text{H}_2$ $\text{CH}_4 + \text{NH}_3 + 1.5\text{O}_2 \rightarrow \text{HCN} + 3\text{H}_2\text{O}$	Degusaa process P: 1 bar T: 1273 – 1573 K, Pt catalyst Andrussow process P: 1 bar T: 1273-1473K; Pt catalyst
Chloromethanes CH_3Cl , CH_2Cl_2 CHCl_3 , CCl_4	$\text{CH}_4 \times \text{Cl}_2 \rightarrow$ $\text{CH}_{4-x} \text{Cl}_x + x\text{HCl};$ $x = 0-4$	T: 673 K; non-catalytic gas phase reaction
Carbon disulphide CS_2	$\text{CH}_4 + 2\text{S}_2 \rightarrow \text{CS}_2 + \text{H}_2 \text{S}$	P; 2.5 bar, T: 873 K
Acetylene Ethylene C_2H_2 , C_2H_4	$2\text{CH}_4 \rightarrow \text{C}_2\text{H}_2, \text{C}_2\text{H}_4, \text{H}_2$	(a) electric arc process (b)partial combustion process
Ethylene and propylene	Oxidative Methane coupling reaction	
Methanol	$\text{CH}_4 + 0.5 \text{O}_2 \rightarrow \text{CH}_3\text{OH}$	T: 633-666K P: 50-150 atm Catalyst: MoO_3 ZnO Fe_2O_3
Chloromethane	$\text{CH}_4 \rightarrow \text{CH}_3\text{Cl}$	T: 523K P: 230 psig Catalyst: Cu_2Cl_2 , KCl and LaCl_3
Aromatics		H-ZSM-5, Ga-ZSM-5 Al-ZSM-5

Natural gas find applications a feed stock in chemical industry for producing a number of methane based and also syngas based products. Natural gas is also an important feed stock for petrochemicals like ethylene and propylene which are key starting material for petrochemical industry. Chloromethane, Carbon black proteins are derived from Natural gas. Hydrogen cyanide, proteins for animal feed are commercially produced from natural gas or methane. The details of the chemicals that can be derived from methane and the conditions employed their manufacture are summarized in Table 6.

9. Natural Gas production in India

Over the last decade, natural gas energy sector gained more importance in India. In 1947 production of natural gas was almost negligible, however at present the production level is of about 87 million standard cubic meters per day (MMSCMD).

Table 7. Production of Petrochemicals from propylene and ethylene which are produced from Methane - Natural gas as feed stock for petrochemicals

Propylene based petrochemicals	Butene based petrochemicals	Natural Gas liquid as feed stock	Ethylene based
Polypropylene Isopropyl alcohol Acrylonitrile Acrylonitrile copolymers Acrolein	Secondary butyl alcohol Butadiene Isobutene Tertiary butyl alcohol Butyl rubber Vistanes rubber	Maleicanhydride Synthesis gas Synthetic natural gas	Low density polyethylene High density polyethylene Ethylene oxide Ethylene glycols Ethanol-acetaldehyde dichloromethane vinyl chloride Polyvinyl chloride, polyvinylalchol Ethyl benzene styrene polystyrene

Oil & Natural Gas Corporation Ltd. (ONGC), Oil India Limited (OIL) and JVs of Tapti, Panna-Mukta and Ravva are the main producers of Natural gas. Western offshore area is major contributing area to the total production. The other areas are the on-shore fields in Assam, Andhra Pradesh and Gujarat States. Smaller quantities of gas are also produced in Tripura, Tamil Nadu and Rajasthan States.

10. Utilization

Natural gas has been utilized in Assam and Gujarat since the sixties. There was a major increase in the production and utilization of natural gas in the late seventies with the development of the Bombay High fields and again in the late eighties when the South Basin field in the Western Offshore was brought to production. The natural gas supplied from western offshore fields utilized by Uran in Maharashtra and partly in Gujarat

The gas brought to Hazira is sour gas which has to be sweetened by removing the sulphur present in the gas. After sweetening, the gas is partly utilized at Hazira and the rest is fed into the Hazira-Bijaipur-Jagdishpur (HBJ) pipeline which passes through Gujarat, Madhya Pradesh, Rajasthan, U.P., Delhi and Haryana. The gas produced in Gujarat, Assam, etc; is utilized within the respective states.

10.1. Natural Gas as source for LPG

Natural Gas is currently the source of half of the LPG produced in the country. LPG is now being extracted from gas at Duliajan in Assam, Bijaipur in M.P., Hazira and Vaghodia in Gujarat, Uran in Maharashtra, Pata in UP and Nagapattinam in Tamil Nadu.

Table 8. All India Region-wise & Sector-wise Gas Supply by GAIL - (2003-04) in (MMSCMD)

Region/Sector	Power	Fertilizer	S. Iron	Others	Total
HVJ & Ex-Hazira	12.61	13.63	1.24	9.81	37.29
Onshore Gujarat	1.66	1.04		2.08	4.78
Uran	3.57	3.53	1.33	1.41	9.85
K.G. Basin	4.96	1.91		0.38	7.25
Cauvery Basin	1.07			0.25	1.32
Assam	0.41	0.04		0.29	0.74
Tripura	1.37			0.01	1.38
Grand Total	25.65	20.15	2.58	14.23	62.61

Two new plants have also been set up at Lakwa in Assam and at Ussar in Maharashtra in 1998-99. One more plant is being set up at Gandhar in Gujarat. Natural gas containing C_2/C_3 , which is a feedstock for the Petrochemical industry, is currently being used at Uran for Maharashtra Gas Cracker Complex at Nagothane. GAIL has also set up a 3 lakh TPA of Ethylene gas based petrochemical complex at Auraiya in 1998-99.

Oil wells are also supplying around 3 MMSCMD in Assam against allocations made by the Government. Around 8.5 MMSCMD of gas is being directly supplied by the JV company at market prices to various consumers. This gas is outside the purview of the Government allocations. In India there is a gap between the production and consumption level of natural gas. This can be overcome by new discovery and by import or by combination of both. Natural gas deposits were found in Gulf of Camu and Krishna Godavari basin, however the consumption cannot be reached by this occurrence. Hence we have to import the natural gas from east side (Bangladesh, Indonesia and Malaysia) and west side (Iran, Qatar and Saudi Arabia)

10.2. Import of Natural Gas to India through Transnational Gas Pipelines

Iran-Pakistan-India (IPI) Pipeline Project

Myanmar-Bangladesh-India Gas Pipeline Project.

Turkmenistan-Afghanistan-Pakistan (TAP) pipeline

10.3. Liquefied Natural gas

Natural gas at $-161\text{ }^{\circ}\text{C}$ transforms into liquid. This is done for easy storage and transportation since it reduces the volume occupied by gas by a factor of 600. LNG is transported in specially built ships with cryogenic tanks. It is received at the LNG receiving terminals and is regassified to be supplied as natural gas to the consumers. Dedicated gas field development and production, liquefaction plant, transportation in special vessels, regassification Plant and Transportation & distribution to the Gas consumer are various steps involved the production and distribution of LNG

10.4. Natural Gas and the Environment

All the fossil fuels, coal, petroleum, and natural gas-release pollutants into the atmosphere when burnt to provide the energy we need. The list of pollutants they release reads like a chemical cornucopia-carbon monoxides, reactive hydrocarbons, nitrogen oxides, sulfur oxides, and solid particulates (ash or soot).The good news is that natural

gas is the most environmentally friendly fossil fuel. It is cleaner burning than coal or petroleum because it contains less carbon than its fossil fuel cousins. Natural gas also has less sulfur and nitrogen compounds and it emits less ash particulates into the air when it is burnt than coal or petroleum fuels.

11. Concluding Remarks

Conversion of coal into other chemicals (especially olefins and other higher hydrocarbons) is still not economically attractive. So research effort should be made to convert the available natural gas into value added chemicals. In Indian context, natural gas can be considered as an alternative source of chemical feedstock for the petrochemical industries in order to reduce the dependence on imported mineral oil. The development of an active and selective catalyst is necessary to make the process of conversion of natural gas into olefins and liquid fuel economically viable. Oxidative coupling of methane into higher hydrocarbons shows promise in near the future. Natural gas is one the viable short and middle term energy for transport application along with its industrial and residential applications.

References

1. B. Viswanathan (Ed.), Natural Gas Prospects and possibilities, The Catalysis Society of India (1992).
2. R. Narayan and B. Viswanathan, "Chemical and Electrochemical energy system" Universities press, 1998, pp 28-35.
3. A. Janssen S. F. Lienin, F. Gassmann and W. Alexander "Model aided policy development for the market penetration of natural gas vehicles in Switzerland, Transportation Research Part A 40 (2006) 316–333.
4. http://en.wikipedia.org/wiki/Natural_gas
5. <http://www.indiainfoline.com/refi/feat/gaen.html>
6. http://www.eia.doe.gov/oiaf/ieo/nat_gas.html

Chapter - 4

COAL

P. Indra Neel

**It's dark as a dungeon and damp as the dew
Where the danger is double and pleasures are few,
Where the rain never falls and the Sun never shines,
It's dark as a dungeon way down in the mine.**

Merle Travis

1. Energy – Present and Future

Clearly, energy security and energy independence are the two challenges ahead of any nation in this new millennium. The global appetite for energy is simply too great and recurring as well. There is an abrupt need to look something beyond incremental changes because the additional energy needed is greater than the total of all the energy currently produced. Energy sources are inevitable for progress and prosperity. Chemistry for sure holds an answer to the challenges ahead since the whole of the industrial society is based upon the following two reactions:

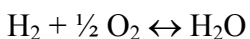
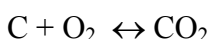

All chemical energy systems, in spite of their inherent differences, are related by the fact that they must involve in some fashion the making and breaking of chemical bonds and the transformation of chemical structure. A chemist with mastery over chemical structures, understanding of the nature of the bonds involved between chemical entities their relative strengths and knowledge of activating C=C, C-C, C-H, C-O, C-N, C-S, H-H and few other bonds can for sure generate vast reserves of energy conversion as well as troubleshoot the problems of environmental pollution.

Society is facing with the problem of energy for sustainable development. What chemists do to address this challenge will have impact reaching far beyond our laboratories and institutions since all human activities, to name a few, agriculture, transportation, construction, entertainment, and communication, are energy driven. Food, clothing and

shelter are the basic amenities of life. The 21st Century has dramatized yet another necessity – The energy. Any small interruption in the availability of energy will have serious implications on the whole of our complex ways of living. Global energy consumption and living standards of the raising population are interdependent. It is predicted that by 2050, i.e., over the next half century, there will be two fold increment in energy consumption from our current burn rate of 12.8 TW to 28.35 TW.

2. Coal – An age old energy source

Probably coal is one energy source whose utility is devoid of its physical form in a sense that it can cater to our energy needs either in solid, liquid or gaseous form as the situation demands. No doubt the heating value changes depending on the amount of hydrogen present per unit weight but the energy source is unique in a way that it can be moulded in the hands of a chemist in accordance with the need. The heating value is tunable.

It is not well documented that when exactly the use of coal has started but it is believed that coal is used for the first time in Europe during Middle Ages.

Just as colours can be classified into primary (red, yellow and blue) and secondary (suitable combination of primary colours yielding green, purple and orange), fuels can also be classified as primary and secondary depending on the readiness of their utility. The major primary fuels are coal, crude petroleum oil and natural gas (contains largely methane). These are naturally available. Coal and Petroleum are sometimes referred to as Fossil fuels meaning they were once living matter. Secondary fuels are those derived from naturally occurring materials by some treatment resulting in drastic and significant alteration in physical and chemical properties like those of coal gas made from solid coal. Coal is the most abundant fossil fuel available world wide. Except coal other fossil fuels resources are limited. Coal is the most abundant fossil fuel on the planet, with current estimates from 216 years global recoverable reserves to over 500 years at current usage rates. But the global distribution of coal is non-uniform like any other mineral deposits or for that matter petroleum. For instance one half of the world's known reserves of coal are in the United States of America.

3. The genesis of coal

Several significant stages in the conversion of wood to coal are shown schematically in Fig.1. These processes took several millions years to take place.

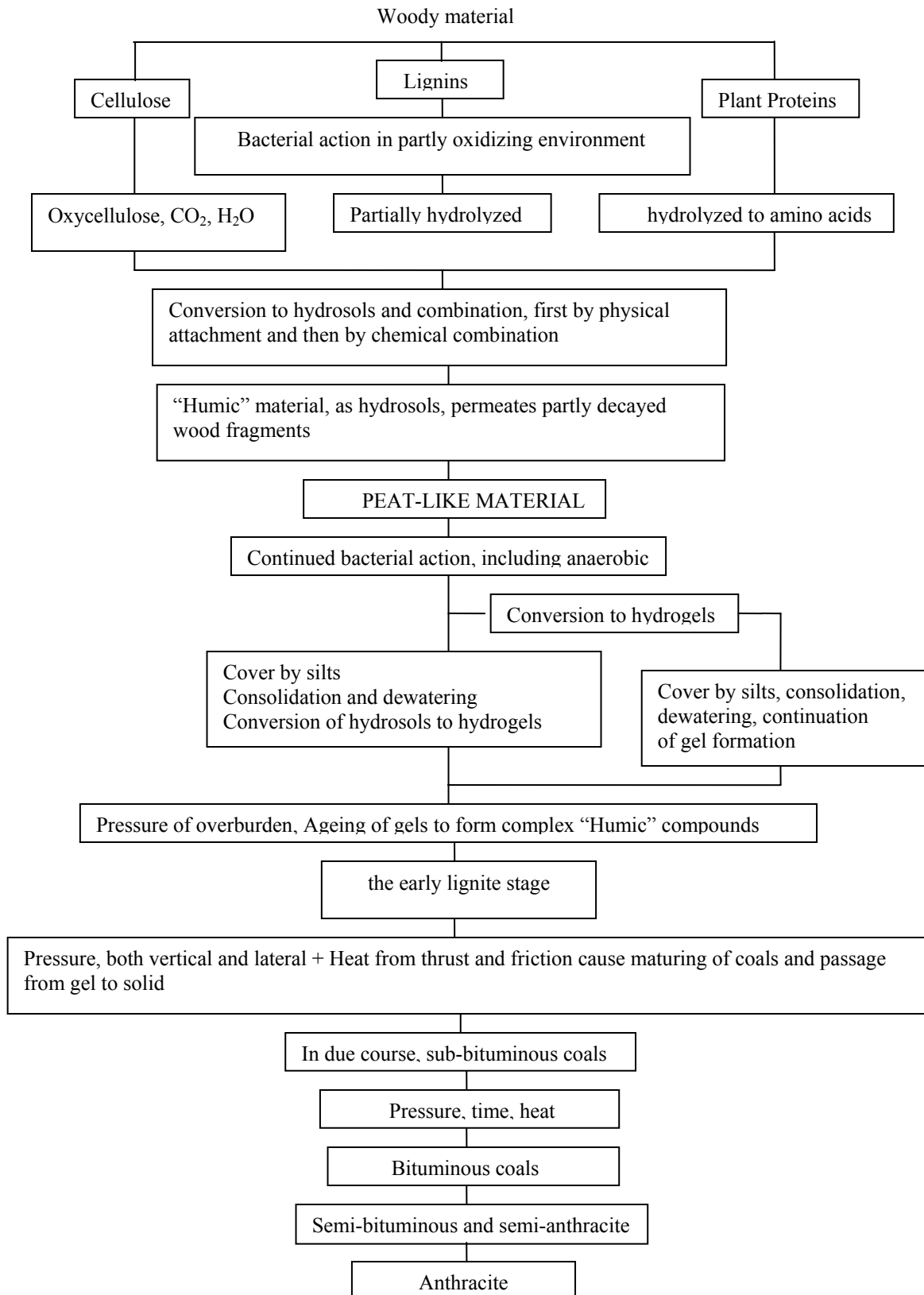

Fig. 1. Schematic diagram of coal genesis (reproduced from ref. 6)

4. Metamorphosis of peat to coal

Coal is formed by the partial decomposition of vegetable matter and is primarily organic in nature. It is well studied as a sedimentary rock. Coal is a complex organic natural product that has evolved from precursor materials over millions of years. It is believed that the formation of coal occurred over geological times in the absence of oxygen there by promoting the formation of a highly carbonaceous product through the loss of oxygen and hydrogen from the original precursor molecules. Simplified representation of coal maturation by inspection of elemental composition is presented in Table 1.

Table 1. Maturation of coal (reproduced from ref. 14)

		Composition, wt%			H/C		
		C	H	O			
Increasing pressure, temperature, time	Wood	49	7	55	1.7	Increasing aromatization loss of oxygen	
	Peat	60	6	34	1.2		
	Lignite coal	70	5	25	0.9		
	Sub-bituminous coal	75	5	20	0.8		
	Bituminous coal	85	5	10	0.7		
	Anthracite coal	94	3	3	0.4		

Each class implies higher carbon content than the preceding one, e.g., bituminous coals have greater carbon content than sub-bituminous coals. As shown coals are composed of C, H, O, N and S. A progressive change in composition is found through the *coal rank series*.

Unfortunately, the concept of coal rank series is the largely undefined concept or term quite often misused by technologists. A coal of a certain level of maturity, or degree of metamorphosis from the peat, is said to be of certain rank. In US coals are classified not on the basis of carbon but on depending on the property. The different types of coals which are clearly recognizable by their different properties and appearance can be arranged in the order of their increasing metamorphosis from the original peat material. They are:

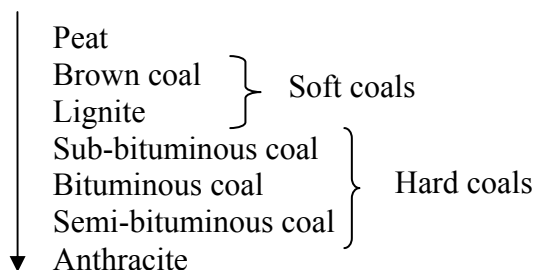

The most highly changed material, this is the final member of the series of coals formed from peat is Anthracite. Each member of the series represents a greater degree of maturity than the preceding one. The whole is known as the “peat-to-anthracite series”.

5. Molecular structure of coal

5.1. Lignite

Lignin structure is preserved in lignites. This means that the macromolecular structure of lignites would consist of small aromatic units (mainly single rings) joined by cross links of aliphatic (methylene) chains or aliphatic ethers. If the polymerization were to be random with cross links heading off in all directions, the structure can be represented as seen in Fig.2.



Fig. 2. Sketch of the “Open Structure” with Extensive cross linking and small aromatic ring systems (reproduced from ref. 4)

5.2. Bituminous coal

Compared to lignites, bituminous coals have higher carbon content and lower oxygen content. The progression of changes that occur in the structure leads to increase on coal rank. The structure will be evolved towards graphite.

Viewed edge-on, graphite would be represented as shown in Fig.3 where the hexagonal layers are perfectly stacked and aligned.

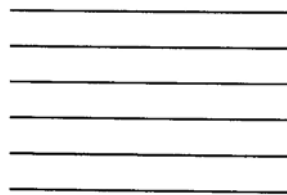

Fig. 3. A “side ways” view of graphite, showing the perfectly stacked aromatic planes (reproduced from ref. 4)

The structure of graphite is represented in Fig.4.

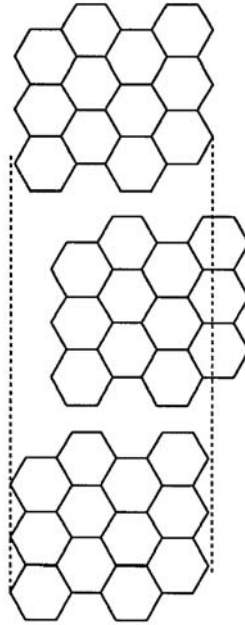

Fig. 4. Layered structure of graphite

Since graphite is a crystalline substance, it produces a characteristic X-ray diffraction pattern which represents or which is characteristic of the interatomic and inter-planar distances in the structure. Most coals in contrast, are nearly amorphous and do not produce sharply-defined X-ray diffraction patterns as graphite. However, when bituminous coals are examined by X-ray diffraction, it is possible to detect weak graphite-like signals emerging from the amorphous background. This information indicates that in bituminous coals the aromatic ring systems are beginning to grow and to become aligned. The structure of bituminous coals with carbon content in the range of 85 to 91 %, the structure can be represented as depicted in Fig.5.

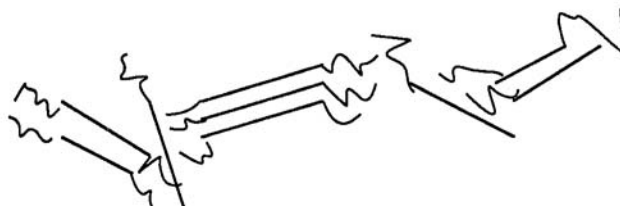

Fig. 5. The “liquid structure” of bituminous coals, with reduced cross linking but increased size of aromatic units relative to the open structure (reproduced from ref. 4)

This is the liquid structure. Compared to the open structure shown earlier, aromatic units are larger and the cross linkings are both shorter and fewer in number and some vertical stacking of the aromatic units is evident.

Some of the configurations understood to exist in coal, giving consideration to aromatic carbon, hydro aromatic carbon and the kinds of structures and kinds of connecting bridges which we think join these structures are presented in Fig.6. It is understood that bituminous coals consist of layers of condensed aromatic and hydroaromatic clusters ranging in size from one to several rings per cluster, with an average of three rings per condensed configuration. The principle types of links or bridges joining these clusters seem to be short aliphatic chains, some ether linkages, some sulfur linkages, and perhaps some biphenyl linkages.

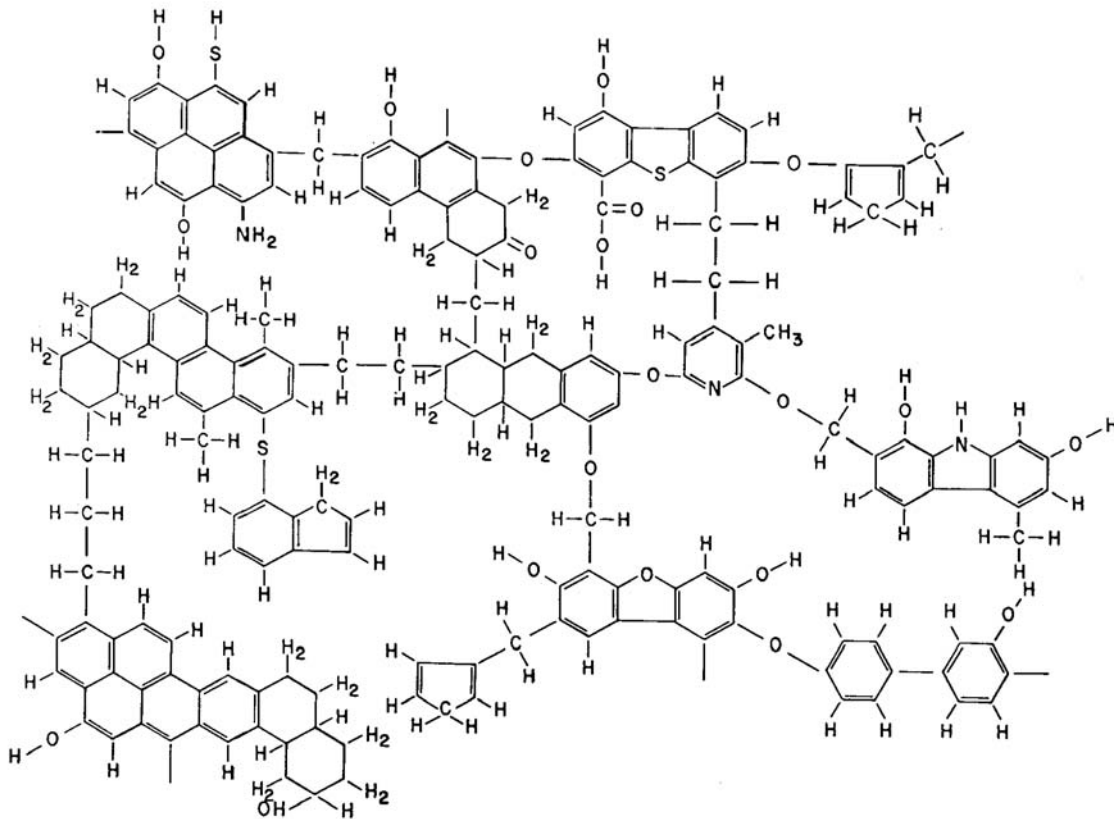

Fig. 6. Schematic representation of structural groups and connecting bridges in bituminous coal

5.3. Anthracites

Anthracites have carbon contents over 91%. The structure of anthracite is approaching that of graphite as represented in Fig.7. X-ray diffraction data shows increased alignment of the aromatic rings with little contribution from aliphatic carbon.

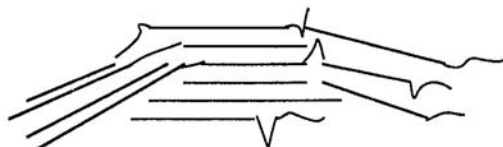

Fig. 7. The “anthracite structure”, with large, fairly well aligned aromatic units and minimal cross linking (reproduced from ref. 4)

6. Coal Petrography – The study of macerals

The branch of science concerned with the visible structure of coal is Coal Petrology or Petrography. The structure may be examined visually by the unaided eye or by optical microscope. Marie Stopes, a British Scientist, established the foundations of the discipline of coal petrography. In other words the Petrography can be defined as the study of coal macerals. In analogy with the minerals of inorganic rock the components of organic rock i.e., coal, are termed as macerals.

Now the question is what is the use of coal petrography? Or what is the importance of petrography in coal research and utilization?

The chemical behaviour and reactivity of coal can be predicted with the knowledge of relative proportions of the different macerals in a coal sample. Different macerals come from different components of the original plant material which eventually resulted in the coal. Different plant components have different molecular structures. Substances having different molecular structures undergo different kinds of chemical reactions under a given set of conditions. Although plant components are altered chemically during coalification, the macerals should still reflect some of the chemical differences inherent of the original plant components. Consequently, one can expect various macerals to show differences in their chemical behaviour. Thus by knowing the relative proportions of the different macerals in a coal sample, it should be possible to predict something on the chemical behaviour and reactivity of the sample.

There are four types of macro-components in coal as visualized by Stopes namely Vitrain, Clarain, Durain and Fussain. According to the terminology of Thiessen, these components correspond to anthraxylon, translucent attritus, opaque attritus and fussain respectively. In a typical coal seam, 50% of the seam may be clarain, 15-30% durain, 10-15% vitrain and 1-2% fussain.

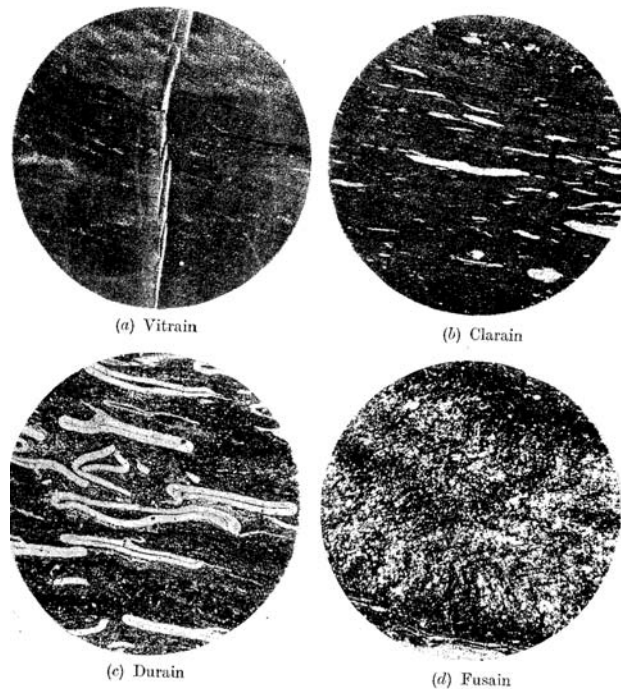

Fig. 8. Sections of Bituminous Coal taken perpendicular to the Bedding Plane

Vitrain: Vitrain is the bright black brittle coal normally occurring in very thin bands. It fractures conchoidally. It is generally translucent and amber-red in colour. A typical thin section of vitrain is shown in Fig.8.

The cells of vitrain consist of complete pieces of bark. Bark tissues are more resistant to decay. As a result, they form a large proportion of coal than might be expected.

Clarain: Clarain is bright black but less bright than vitrain. It is often finely banded so that it tends to break irregularly. In thin sections it shows partly the same appearance as vitrain in thin bands, but these are inter banded with more opaque bands consisting largely of fragmented plant remains among which can be identified cellular material,

spore exines and cuticle. A typical clarain structure is shown in Fig.8. It contains more plant remains than vitrian and is the commonest of the four types of coal substances.

Durain: Durain is the dull-greyish-black coal which is hard and tough and breaks irregularly. It is fairly opaque in thin sections and shows large and small pore exines and woody fragments in a matrix of opaque grains. A typical durain structure with large flattened macrospores is shown in Fig.8.

In the coal seam, durain bands are often thick, and can be followed through out the area of the seam. It is highly charged with durable plant remains and is supposed to be formed from silts or muds of small particles of vegetable matter.

Fussain: It is soft powdery form occurring in thin seams between the bands of other types. It is a friable, charcoal like substance which dirties the hand when coal is touched. It is non-coking but when fines are present in small percentage in coal charge, they help in increasing the strength of the coke produced there from. Fixed carbon content is higher and volatile matter is lower in fussain than in other banded ingredients.

7. Constitution of coal

7.1. The variation of oxygen content with rank

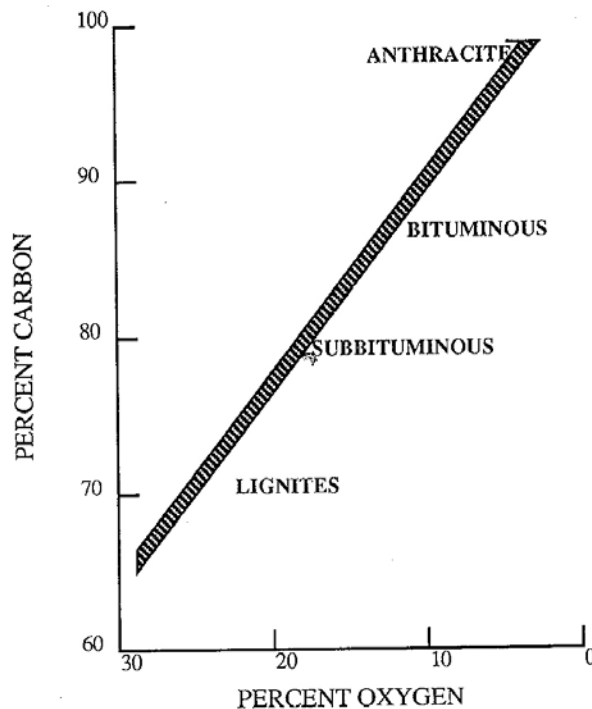

Fig. 9. The variation of oxygen content with rank (reproduced from ref. 4)

There is very large variation of oxygen content as a function of carbon content, from nearly 30% in the brown coals to ≈ 2 in the anthracites. The variation of oxygen content with rank is illustrated in Fig.9. It can be learnt that oxygen content and the quality of coal (rank) are intimately related and as the ranking increases the oxygen content decrease as seen in the plot. On the weight basis, oxygen is generally the second most important element in coal. The oxygen content of coal has several practical implications. The presence of oxygen detracts from the calorific value.

As a rule, for a give amount of carbon, as the oxygen content increases and hydrogen decreases, the calorific value will drop. This is seen from the values given in Table 2.

Table 2. Effect of oxygen content on calorific value

Compound	H/C	O/C	Heat of combustion, kJ/mole
Methane	4	0	883
Formaldehyde	2	1	543

Some additional data in support of the above statement are given in Table 3.

Table 3. Effect of increasing oxygen content on heat of combustion of four-carbon-atom compounds

Compound	Formula	$-\Delta H$, kJ/mole
Butane	$\text{CH}_3\text{CH}_2\text{CH}_2\text{CH}_3$	2880
1-Butanol	$\text{CH}_3\text{CH}_2\text{CH}_2\text{CH}_2\text{OH}$	2675
2-Butanone	$\text{CH}_3\text{CH}_2\text{COCH}_3$	2436
Butanoic acid	$\text{CH}_3\text{CH}_2\text{CH}_2\text{COOH}$	2193
Butanedioic acid	$\text{HOOCCH}_2\text{CH}_2\text{COOH}$	2156

7.2. The variation of the principal oxygen functional groups with carbon content

The oxygen containing structures represent functional groups, the sites where chemical reactions occur. The principal oxygen functional groups in coals are carboxylic acids, phenols, ketones or quinones, and ethers (Fig.10)

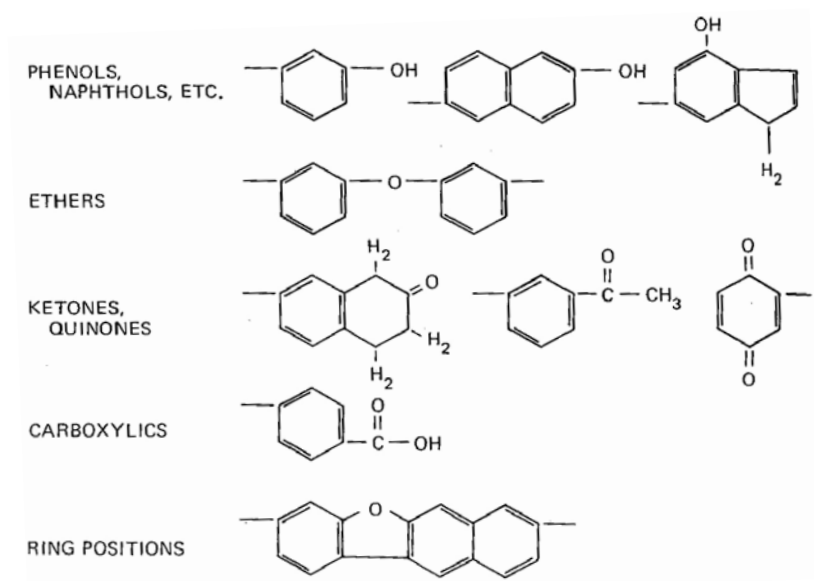

Fig. 10. Principle oxygen functional groups in coal

Other oxygen functional groups of little importance or absent from coals are esters, aliphatic alcohols, aldehydes, and peroxides.

The variation of oxygen functional groups as a function of carbon content in vitrinites (the most common component of coal) is shown in Fig.11.

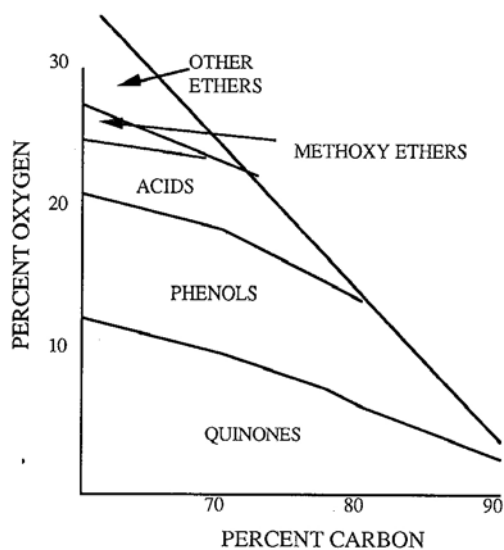

Fig. 11. The variation of principal oxygen functional groups with carbon content (reproduced from ref. 4)

Methoxy groups are important only in coals with carbon content < 72 wt%. These groups are derived from lignin, and their loss with increasing coalification suggests that lignin structures have been completely coalified by the time that the coal has reached subbituminous rank. Phenols and quinones are the main oxygen groups in the high rank coals, although some ether may persist in high ranks.

7.3. Determination of fixed carbon content

When coal is heated in an inert atmosphere to about 105 °C, a weight loss occurs. Inert atmosphere can be either nitrogen or argon preferably. The weight loss is a result of water being driven off; this weight loss is used to calculate the moisture content of the sample. If the temperature is increased substantially, to 950 °C under inert atmosphere a second weight loss is observed. Under these conditions a variety of materials, including CO₂, CO and a mixture of hydrocarbons are evolved. The components emitted during this experiment are never determined individually. Rather they are lumped together under the term volatile matter. Thus the weight loss observed at 950 °C provides a measure of the volatile matter associated with the coal sample. At the end of the volatile matter test, a black carbonaceous solid still remains. It contains carbon which was not emitted during the volatile matter determination. If this carbon material remaining from the volatile matter test is heated in air it burns, leaving behind an incombustible inorganic, residue, and ash. The ash is collected and weighted.

Three components – moisture, volatile matter and ash – are determined directly. The fixed carbon is calculated indirectly as:

$\% \text{FC} = 100 - (\% \text{M} + \% \text{VM} + \% \text{A})$, where FC = fixed carbon, M = moisture, VM = volatile matter, A = ash;

7.4. Proximate analysis

A proximate analysis is not approximate analysis! It is unfortunate that the name proximate sounds much like the word approximate. The procedures for the proximate analysis are rigorously established by the American Society for testing and materials (ASTM) along with standards for the acceptable levels of error with in a laboratory and between different laboratories.

In the above described method of analysis of %M, %VM, %A and there by %FC, the actual components of the volatile matter, ash or fixed carbon are never determined. That

is, the carbon dioxide evolved in the volatile matter is never collected, determined and reported as some percentage of CO₂. In analytical chemistry the practice of lumping a variety of components and reporting them as a single entity is called proximate analysis. The proximate analysis of coal is therefore the determination of moisture of volatile matter, fixed carbon and ash.

Ash content

Strictly speaking, there is no ash in coal. The incombustible residue, ash, remaining after the combustion of coal is actually the product of high temperature reactions of inorganic components, termed as mineral matter, originally present in the coal. It should be noted that, the amount of ash is not necessarily equal to the amount of original mineral matter.

Fuel ratio of the coal

The fuel ratio of a coal is defined as the ratio of fixed carbon to volatile matter. Coals with a high volatile matter are usually easy to ignite, burn with a large, often smoky flame and burn quickly. Coals with high fixed carbon are hard to ignite, but burn slowly with a short, clean flame.

7.5. Ultimate analysis

The determination of the principal elements of coal, namely, carbon, hydrogen, oxygen, nitrogen and sulfur is called the ultimate analysis. It is not 'ultimate', in the sense of determining completely the elemental composition of coal. It is because, the careful analysis of a coal sample, including the mineral matter, to the trace level would show that coal contains virtually every element in the periodic table except the rare gases and the man-made highly, unstable elements and so complete determination of composition and ultimate analysis are not one and the same which should be borne in mind.

Mineral matter of coal

All elements in coal except C, H, N, O and S will be termed as mineral matter even if they are present as organometallics, chelates, or absorbed species. Inorganic sulphur and inorganic oxygen (sulphur and oxygen not present in heteroaromatic structure) will also be considered as mineral matter.

Iron, silica and alumina constitute the major portion of mineral matter in coal. The four major groups of mineral matter include alumino-silicates (clay minerals), carbonates,

sulfides and silicates (mainly quartz). The clay materials are dominant minerals present in most coals, while pyrite is dominant among sulfides.

Table 4. Mineral matter present in coal (reproduced from ref. 5)

Normal state of combination	% of total mineral matter
Silica and silicates of aluminium	50-90%
Pyrite (FeS ₂), ferrous carbonate, ferrous and ferric sulphate and silicates	0-20%
Carbonate, sulphate and silicates of calcium	0-20%
Carbonate and silicate of magnesium	0-8%
Chloride, carbonate and silicate of sodium and potassium	0-4%
Titanium oxide	0-2%
Carbonate and silicate of manganese	Traces
Sulphur as sulphides and sulphates	0.5-10%
Oxides of phosphorous, gallium, germanium, nickel, beryllium etc.,	<1%

8. Carbonization

The process of heating coals in the absence of air to temperatures at which the coal decomposes is known as Carbonization. Some coals when carbonized fuse and form a coal where as others do not. Instead they leave a solid residue on carbonization of charred material which is of the same shape as the original coal (it has not fused) and is soft and easily crushed. Even those coals which form fused residues (fused cokes) differ in the extent to which they do so. They form cokes of different strengths. Coals are commonly referred to in terms of their ability to form strong coke when carbonized. They are described as non-caking, weakly caking, or strongly caking. Alternately, they are said to have poor, or weak, or strong caking properties.

8.1. The caking property

Upon hearing the concept of Caking property the spontaneous questions arise in our mind are whether it is an advantageous or disadvantageous property and to what extent? What coal has to do with caking? What gasoline has to do with sweetening? What 'approximate' has to do with proximate analysis? What 'complete' need to do with

ultimate analysis? What does a bomb has to do with calorific value? Does petrography has any thing to do with petrol? Does the concept of caking imply that coal can be converted to a delicious, delightful and flexible birthday cake? No!

In Science it is a fallacy or in appropriate terms fashion that with the onslaught of time the original thoughts or views of the inventor are misinterpreted or manipulated or misunderstood in many instances for we have no time to go into details and facts and also short routes are always available in all walks of life whether good or bad. It appears now that there is a mismatch between the terminology and the property which the terminology is addressing. The reasons for this in general are not known still. But even now enough care can be taken by young researchers to look into facts as they mean exactly and as they implied when they were proposed by the scientists since all the proposals withstood the test of time, well documented and made available to the needy.

Knowledge of caking properties is essential since this decides the end application of coals whether it be in the manufacturing of metallurgical coke or in coal-fired furnaces or for any other specific application. A measure of caking property is necessary for the classification and selection of coal for different uses. Caking properties influence the production of coke and the performance of the coal in combustion and gasification.

As a rule caking coals are coals of high volatile, medium volatile and low volatile bituminous rank. The medium volatile bituminous coals are particularly good caking coals. Caking coals form an integral part of bituminous family of coal alone. Peat, lignite, sub-bituminous, semi-anthracite and anthracite are all non-caking.

Coal when heated in an inert atmosphere decomposes with the evolution of a variety of volatile materials. Some coals pass through a plastic state in which the coal appears to soften, swell, and then resolidify into a porous mass. Coals which exhibit this behaviour are called caking coals. When the plastic behaviour is such that the resulting solid product is a very strong, hard, porous mass, the product is called coke, and the original coal is called a coking coal. Coke is an important fuel in the metallurgical industry, particularly in iron and steel industry. Supplies of coking coals are very valuable. All coking coals are caking coals, but not all caking coals yield a commercially desirable coke. So, not all caking coals are coking coals.

8.2. Free Swelling Index

The caking behaviour of a coal is measured in USA by the free swelling index, often known as FSI. It denotes the caking capacity of coal. In this test a known quantity of coal is heated in a standard sized crucible under standardized conditions (820 °C for 2.5 minutes). The FSI is determined by comparing the size and shape of the resulting solid “button” with a series of standard outlines as depicted in Fig. and assigning a value from 1 to 9 at an interval of 0.5. Standard profile of coke buttons numbered from 1 to 9 (at an interval of 0.5 units) is shown in Fig.12. An FSI of 0 is assigned to a material which does not form a coherent mass but rather falls apart when removed from the crucible.

In UK, the caking property is evaluated in terms of British Standard Swelling Number (BSS No.) Each of these numbers from 1 to 9 at an interval of $\frac{1}{2}$ bear a great significance as far as the properties and end use of coal are concerned. They indicate the industrial purpose for which a coal is suitable.

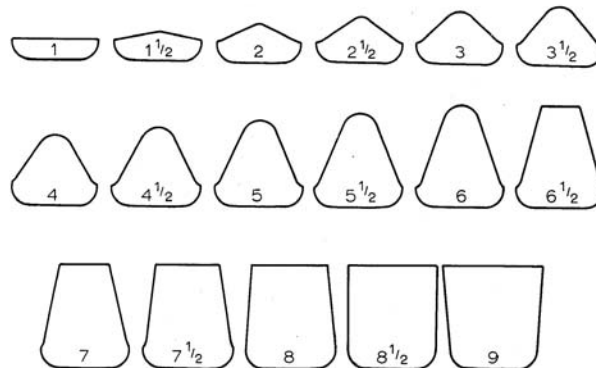

Fig. 12. Standard profiles of the British Standard Swelling Number Test (reproduced from ref. 6)

B.S.S. No. less than 2 1/2 - Very weak caking properties, or non caking. Coals suitable for steam raising and other furnaces but unsuitable for any form of carbonization.

B.S.S. No. 3 & 3 1/2 - Coals of rather weak to moderate caking power. These are suitable for all combustion purposes. They are suitable for carbonization in gas-works but unsuitable for making metallurgical coke.

B.S.S. No. 4-6 1/2 - Coals of moderate caking power. These are suitable for combustion purposes but tend to be rather too strongly caking for some forms of mechanical stokes. They are very suitable for gas-works and for making second grade metallurgical coke.

B.S.S. No. 7-9 – Strongly caking coals. These coals are too strongly caking to be really suitable for combustion to be really suitable for combustion in furnaces and rather too strongly caking for use in gas works. This range includes the coals which are best for making metallurgical cokes in coke ovens.

The Bureau of Indian Standards has adopted FSI as one of the tests for caking properties. The demerits of the test lie in its trial-and-error approach.

9. Coal for the generation of electricity

From coal to electricity generation is not a single step conversion as we see in Fuel cells where in chemical energy, from any of the hydrocarbon fuels, is directly converted to electrical energy. The purpose of coal is only to get heat energy. This heat energy in turn is used to convert water to steam. The steam makes the propeller-like blades of the turbine to rotate at high speeds. A generator connected to the turbine converts mechanical energy to electrical energy. The various components and steps involved in the generation of electricity are depicted in Fig. 13.

The electricity generated is transformed into the higher voltages upto 4,00,000 volts and used for economic, efficient transmission via power line grids. When it nears the point of consumption, such as our homes, the electricity is transformed down to the safer 100-250 V used in the domestic market.

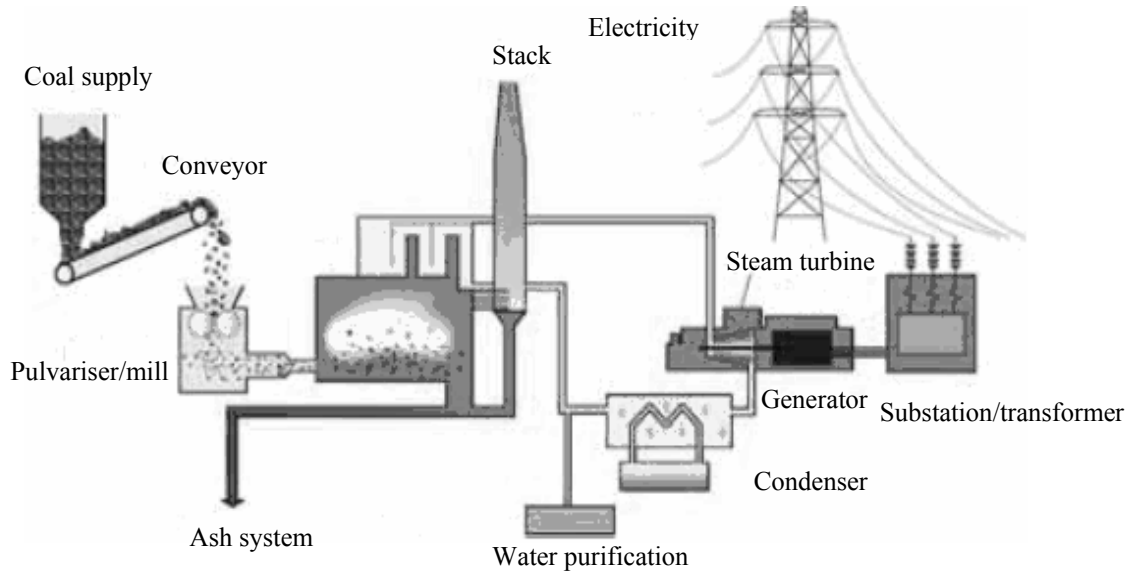

Fig.13. Schematic representation of the processes taking place in a power plant

Modern pulverized coal combustion technology is well- developed and accounts for over 90% of coal fired capacity world wide. Improvements are being made in the direction of producing more electricity from less coal being used i.e., to improve the thermal efficiency of the power station.

9.1. Zero emission power plants – The need of the hour

Zero emission power generation (ZEPG) refers to a range of technologies that are capable of producing electricity with CO₂ emissions that are 10% lower of those from a conventional plant. Their development is vital for achieving major 50-60% long term reduction in green house gas emissions.

The significance of the zero emission power plants is well recognized from the statement of the US President George W. Bush - “Today I am pleased to announce that the United States will sponsor a \$1 billion, 10-year demonstration project to create the worlds first coal-based, zero-emission electricity and hydrogen power plant”, on 27th February, 2003.

Future Gen, a project of US DOE, is viewed as tomorrow’s pollution-free power plant. It is an initiative to build the world’s first integrated sequestration and hydrogen production research power plant.

The goal of the US department of Energy’s Future Gen project initiative is to develop and demonstrate technology for ultra clean 21st century energy plants that effectively remove environmental concerns associated with the use of fossil fuels for producing electricity and simultaneously develop highly efficient and cost-effective power plants. Such projects truly hold a promise for the safe and ecofriendly utilization of our age old energy source – Coal.

9.3. Hydrogen content and heating value

Hydrogen is a well-known energy carrier like electricity. Hydrogen content has a role to play in deciding the heating value per unit of any of the fossil fuels namely coal, oil or natural gas. Oil and natural gas are considered to be more versatile than coal because of the higher hydrogen contents they possess in comparison to coal. The hydrogen contents of coal, oil and natural gas are 7.0, 13 and 25 wt % respectively.

The question one needs to pose is that can we increase the hydrogen content per unit weight of coal? The answer lies in the processes of gasification and liquefaction of coal

where in the prime motto is to add hydrogen. The processes of gasification as well as liquefaction of coal primarily differ in terms of operating conditions. Even though the chemical reactions operative are different, they are only secondary.

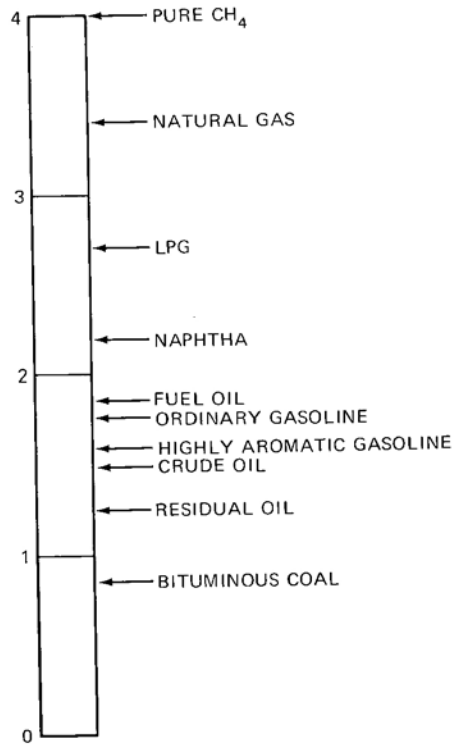

Fig. 14. Atomic hydrogen/carbon ratios for bituminous coal and other fuels

We are starting with coal, a material that is possessing around 0.8 to 0.9 hydrogen atoms per carbon atom and we want to produce some thin considerably richer in hydrogen (Fig. 14). In a raw primary liquid fuel produced from coal the hydrogen/carbon ratio on an atomic basis is about 1.1 to 1.2. If we want a distillate-type fuel, we need a ratio of at least 1.6.

If it is desired to optimize the production of liquid the production of gases must be minimized since we need 4 hydrogen atoms per carbon atom to produce methane. Hydrogen cost is a significantly expensive item in coal liquefaction processes.

10. Coal liquefaction

10.1. Historical background

Is it not surprising to convert a rock into liquid! Coal is quite often termed as a heterogeneous rock of organic origin containing significant inorganic mineral matter. The thought of transforming coal into liquid began in 1869 when Bertholet demonstrated that coal could be hydrogenated. However, it is only with Bergius in 1913, high pressure hydrogenation and hydrodesulphurization of coal began on practical scale. Bergius employed the high-pressure technology of the Haber ammonia process to hydrogenate coal at elevated temperatures and pressure. The major commercial developers of hydrogenation were I. G. Farben industrie A. G. (I. G. Farben) and BASF. Initial goals of research at I. G. Farben were to design an effective slurry-phase hydrogenation catalyst and a sulfur-resistant vapour-phase catalyst that would survive the inherent sulfur in the coals. The development of a supported catalyst composed on pelleted Mo and Zn oxides was a breakthrough by Pier in 1926. In 1934, I. G. Farben switched from Molybdenum to Iron oxide as a slurry-phase catalyst. In slurry phase mode disposable catalysts such as inexpensive ores, coal minerals and metallic wastes will be employed. Catalyst self-sufficiency and no concern for catalyst deactivation or recovery are the advantages in this mode. Slurry – phase catalysts are coal minerals and iron sulfides. Even though the use of ‘a disposable’ or a slurry-phase, catalyst in direct coal liquefaction was initiated in the Bergius process, currently SRC-II technology is being employed where the presence of recycled coal mineral matter considerably enhanced coal liquefaction.

10.2. The process of liquefaction of coal

Liquid fuel from coal could be a future alternative to conventional petroleum. From each ton of coal one to four barrels of oil can be produced. In spite of the vast technology base for coal liquefaction, the efforts to build commercial plants have subsidized. High capital costs of synthetic oil plants and declining oil prices were the major obstacles. If costs would become competitive, coal could be the future source of liquid fuels.

Major issues of concern in the liquefaction of coal are as follows:

1. Process thermal efficiency
2. Hydrogen utilization

3. Materials and components reliability
4. Solid-liquid separation
5. Product quality and flexibility
6. Feed coal flexibility and
7. Process severity

Among the major areas of concern listed above, the efficient utilization of hydrogen is one of the critical aspects in direct liquefaction. Effective utilization of hydrogen is important from the stand point of reaction chemistry, reaction mechanism and economics of the process. The cost of hydrogen production itself is 1/5 to 1/3 of the direct capital expenditure of coal liquefaction plants. Hydrogen stabilizes the reactive and unstable free radicals formed by thermal rupture of chemical bonds of the coal macromolecules. This prevents the occurrence of retrogressive reactions that produce the undesirable high molecular weight products that reduce the yield of desired liquid products.

A number of competing parallel reactions may be seen below:

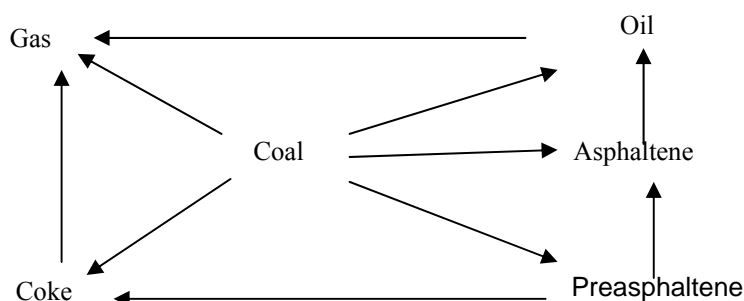

The overall conversion of coal can be regarded as a series of thermal decomposition/hydrogenation reactions such as the above. Preasphaltene, Asphaltene and oil are defined as tetrahydrofuran soluble – toluene insoluble, toluene soluble – pentane insoluble and pentane soluble coal liquids respectively.

10.3. Catalysis in the liquefaction of coal

One of the important strategies in the process of liquefaction of coal is hydrogen economy. That is the effective utilization of hydrogen.

Now the question is which is the most efficient method of hydrogen transfer? This is where the role of catalyst becomes vital in the liquefaction of coal.

A catalyst need to efficiently transfer and distribute hydrogen.

An ideal catalyst should possess the following properties:

1. High activities for hydrogenation, cracking, and heteroatom removal,
2. Selectivity for maximum liquid yield with minimum gas production,
3. Adequate physical strength to overcome mechanical degradation with aging and regeneration and
4. Resistance to deactivation caused by coke and metal deposition, poisoning, sintering and pore-mouth blockage.

An effective catalyst should help liquefy coal at lower severity conditions and improve liquid yield and quality. Catalysts in direct coal liquefaction lower the severity of the operations essentially by activating both the molecular hydrogen and also the coal molecules that to at lower reaction temperatures. They improve the product quality by cracking and reforming heavy molecules to desired products; and removing heteroatoms (atoms other than C) namely N, O, S from coal and coal liquids.

The advantages offered by catalysts in this regard are many. But all is not easy and hurdles arise because of the complex nature of coals. Coal, frequently referred as “Nature’s Dump”, tends to deactivate the catalyst. Most vital reasons for catalyst deactivation are coke formation as well as metal deposition apart from poisoning or sintering which are not as pernicious as those of the former.

Studies reveal that addition of Iron pyrite (FeS_2) to coal/oil slurry produces higher conversion and improved product quality. In quantitative terms addition of five percent of iron pyrite produces the same increase in conversion as that produced by a 20°C increase in reaction temperature. Unfortunately, the catalytically active chemical state of the iron sulfide is not definitely known. Most of the studies strongly suggest that pyrite is not the active catalyst in coal liquefaction but plays the role of a precursor. Pyrrholite (Fe_{1-x}S , where $0 < x < 0.125$) a non-stoichiometric sulfur-rich crystalline structure, has been suggested as the catalytically active ingredient in liquefaction. Thus the catalytic action of pyrite is attributed to its transformation products (pyrrholite and H_2S). The critical parameter in the formation of catalytically active pyrrholite is the partial pressure of H_2S . In addition hydrogen sulfide by itself is catalytically active in the liquefaction of coal.

10.4. Hydrogen sources

The hydroaromatic portion of coal itself can act as a source for hydrogen. Apart from this gaseous hydrogen as well as hydrogen-donor solvents can also serve the purpose. The process of hydrogen addition or hydrogenation can be accomplished either by catalytic or non-catalytic means. But non-catalytic addition of hydrogen to coal molecules requires employment of drastic conditions of temperature and pressure. Use of a catalyst reduces the severity of the process by bringing down the temperature and pressure. Good hydrogen donor solvents such as 1, 2, 3, 4-tetra hydro naphthalene, generally known as tetralin, can serve the purpose of supplying hydrogen and stabilizing the free radicals generated by coal molecules. The reaction can be envisioned as follows

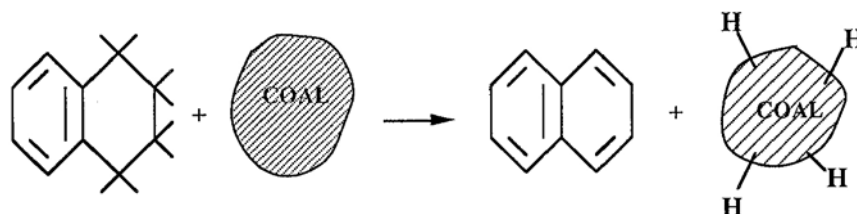

which may proceed sequentially through 1, 2 dihydro naphthalene? The hydrogen donated by the tetralin is used to cap radicals, thus facilitating coal depolymerization and liquids production.

However, once the solvent gets depleted of hydrogen it needs to get rehydrogenated through catalytic means. Tetralin is regenerated as follows:

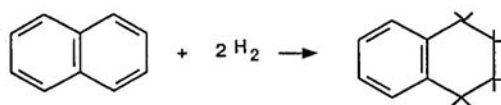

The net process of hydrogenation is represented pictorially as:

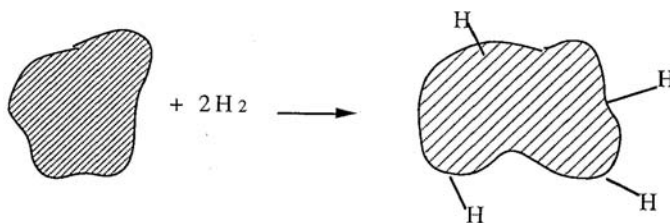

10.5. Coal Blending

Coal blending is a process of mixing two coals of different reactivities. Alternately, coal-derived ash and/or mineral matter from a reactive coal are added to a less reactive coal. Coals differ in their liquefaction reactivity due to rank, petrography and concentration of mineral matter. Addition of a highly reactive coal to a low reactive coal can increase conversion and lower operating severity in a liquefaction plant. Coal blending is beneficial in a way that this decreases the severity of plant operating conditions.

10.6. Coal gasification

The steps involved in coal gasification and the products obtained thereby are shown schematically in Fig.15.

Ideally it is desirable to gasify coal according to the reaction:



Methane, the principle component of natural gas is produced directly by the above reaction. Even though a small amount of heat is required for the reaction to sustain as indicated by the small positive ΔH (endothermic reaction), several favourable reactions compete with this reaction making the production of methane indirect. In addition to the small amount of CH_4 produced directly in the gasifier, the exit gas will contain CO , CO_2 , H_2 , H_2S and H_2O as shown in Fig. 15. Presence of NH_3 depends on whether we use air or oxygen in the process and the presence of nitrogen in air obviously leads to the evolution of NH_3 .

It should be noted that the gasification of the coal takes place in stage 1 itself. The remaining stages represent processes for the removal of CO_2 and H_2O , removal of Sulphur, generally as H_2S and also upgrading the heating value of the gas by methanation. CO and H_2O evolved in stage 1 have no heating value. They undergo water gas shift reaction in stage 2 as shown below.

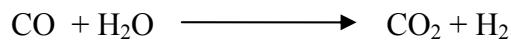

The objective of this operation is to bring the mole ratio of H_2 to CO to a value of 3 to 1. Once this mole ratio of H_2 and CO is achieved, CO can be converted to CH_4 and other hydrocarbons (Fischer Tropsch synthesis, a process in which CO and hydrogen are converted to higher hydrocarbons and alcohols on supported cobalt or iron catalyst) (stage 4).

The acid gases, H₂S and CO₂ are removed in stage 3. This is normally done in a wet collector called a scrubber. Proper choice of a scrubbing liquid allows selective absorption of H₂S and CO₂.

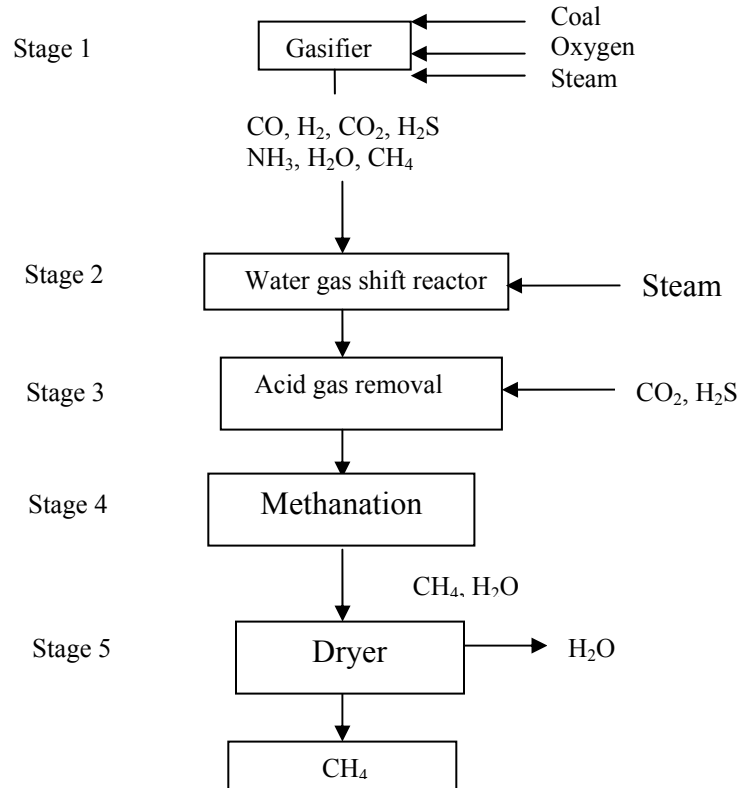

Fig.15. Schematic representation of various steps in the gasification of coal

Methanation is accomplished in stage 4 by the conversion of CO and H₂ according to the reaction.



This reaction must be catalyzed to proceed at an economical rate. The large, negative ΔH indicates that the reaction is strongly exothermic and hence cooling must be provided.

The methane produced in stage 4 is referred to as synthetic natural gas (SNG). The process of drying is carried out in stage 5 where water is eliminated with the objective of increasing the heating value of the gas. The drying process is carried out by passing them through agent such as sulfuric acid, calcium chloride, or silica gel. The water vapour is absorbed by these dehydrating agents.

Normally three kinds of gasifier operations, namely, (1) moving bed gasifier, (2) fixed fluidized bed and (3) entrained fluidized bed are used.

10.7. In situ gasification of under ground coal

In place or in situ combustion of coal is yet another possible option to extract the heat energy from coal. This is employed where coal cannot be mined economically or for those coal deposits remaining after deep mining operations.

Oxygen and steam are piped down to the deposit and the gasified products are brought to the surface through the wells.

The following are some of the advantages with this form of gasification:

(1) It can be used for un-minable coal deposits, (2) miners health and safety problems are eliminated, (3) the cost of mining is eliminated, (4) air pollution and solid waste disposal normally encountered in above-ground gasifications are eliminated.

This process is not devoid of disadvantages. They are as follows: (1) there can be ground water contamination and gas a leakage problems, (2) it consumes more oxygen per energy content in the produced gas than in the case of conventional gasifiers, (3) it can generate only low pressure synthesis gas, and (4) the under ground coal gasification can be used only for reactive and permeable coals.

This method consists of several steps. First, chemical explosives are used in an array of drilled holes to fracture a coal bed. Explosions create passages for the flow of gasification fluids as well as gaseous products. Collection wells would be drilled to the bottom of the fractured zone. The top would be ignited and a steam-oxygen mixture would be pumped into the coal vein. The product gases would contain CH_4 , CO , CO_2 , H_2S and H_2 similar to surface gasification operations. This can either be burned for electric power generation after cleaning or be further processed by methanation to upgrade its heating value.

10.8. Chemicals from coal

Coal bears significance in terms of producing industrially important chemicals too, apart from being used as a source of energy. The following table lists the major organic and inorganic chemicals that can be made from coal. It is known that half the chemicals that can be obtained are olefins and aromatics.

Table 5. Some major chemicals derived from coal (reproduced from ref. 3)

Organic chemicals	Acetic acid
	Acetone
	Acrylonitrile
	Benzene
	Carbon tetrachloride
	Cumene
	Cyclohexane
	Ethylene
	Ethylene oxide
	Formaldehyde
	Isopropyl alcohol
	Methanol
	Perchloroethylene
	Phenol
	Phthalic anhydride
	Propylene
	Propylene oxide
	Styrene
	Toluene
	Urea
Vinyl acetate	
<i>o</i> -xylene	
<i>p</i> -xylene	
Inorganic chemicals	Ammonia
	Sulphuric acid

Current production of chemicals from coal is based on Eastman process. The Eastman process involves the production of methanol from synthesis gas.

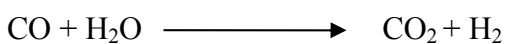
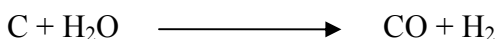

Methanol is reacted with acetic acid to form methyl acetate

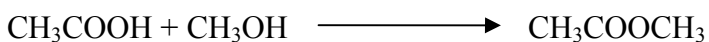

Methyl acetate can be further reacted with carbon monoxide to form acetic anhydride

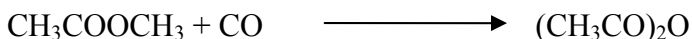

Acetic acid can be reacted with ethane to make vinyl acetate.

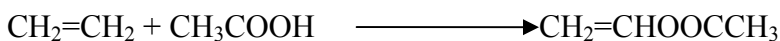

Vinyl acetate can be polymerized to poly(vinyl acetate).

11. Calorific value and its determination

Calorific value (CV) is defined as the quantity of heat liberated by the combustion of unit quantity of fuel.

11.1. Determination of CV

The accurate determination of calorific value requires highly specialized apparatus and facilities. There is no acceptable, simple means of making this determination. The only worthwhile determination is that made by a Bomb Calorimeter.

Bomb calorimeter consists of a strong stainless steel vessel, called bomb, capable of with standing high pressures. The bomb is provided with a lid which can be screwed firmly on the bomb. The lid in turn is provided with two electrodes and an oxygen inlet valve. One of the electrodes is provided with a ring to accommodate the silica crucible.

The bomb is placed in a copper calorimeter having a known weight of water. The copper calorimeter, in turn, is surrounded by an air-jacket and water jacket to prevent loss of heat due to radiation. The calorimeter is provided with an electrical stirrer for stirring water and a Beckmann thermometer. The details are shown in Fig.16.

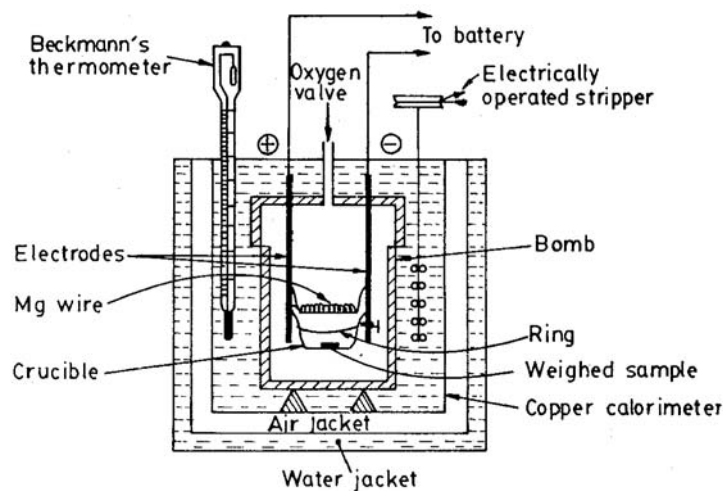

Fig.16. Bomb Calorimeter

Working: A weighted amount of the fuel is placed in the silica crucible. The crucible is supported over the ring. A fine magnesium wire touching the fuel sample is stretched across the electrodes. Oxygen supply is forced into the bomb till a pressure of 25-30 atmospheres is reached. Initial temperature of the water in the calorimeter is noted after through stirring. The current is switched on and the fuel in the crucible burns with the

evolution of heat. The heat produced by burning of the fuel is transferred to water which is stirred throughout the experiment by the electric stirrer. Maximum temperature shown by thermometer is recorded.

In order to calculate the heat liberated by the combustion of the fuel, the weight of water in the whole apparatus must be known. Also the amount of heat required to raise all the parts (metal, glass etc.) in contact with water through the observed raise in temperature. This is evaluated in a calibrating experiment. In this a known weight of a pure hydrocarbon of known calorific value is burned in the apparatus and the raise in temperature is noted.

11.2. Gross and Net calorific value

The heat evolved by burning the pure substance minus the heat required to raise the temperature of the water by the observed amount is the heat required to raise the temperature of the various parts of the apparatus by the same amount. A constant for the apparatus is derived by dividing this amount of heat by the observed rise in temperature. This constant is known as water equivalent of the apparatus. It is expressed as the number of grams of water which are equivalent in heat capacity to the various parts of the apparatus which are heated by the calorimeter water.

Gross calorific value = the heat evolved (in calories) by a known weight of fuel = the rise in temperature in degrees centigrade x (water in calorimeter vessel + water in bomb + water equivalent of the apparatus, all in grams)

11.3. Need for Net calorific value

Calorific values as determined with the bomb calorimeter represent the heat produced by unit weight of coal when completely oxidized, the products of the combustion (CO₂ and H₂O etc.) being cooled to room temperature. This value is not realized in practice because the products of combustion are not cooled to room temperature before being discharged to waste.

Sensible heat is lost in the hot waste products. Apart from this further heat loss occurs in practice as the latent heat of steam in the hot waste gases. Water is present as such as moisture in the air-dried coal and a further amount is formed by the combustion of the hydrogen combined with carbon in the coal. In the bomb calorimeter the moisture is first evaporated and then condensed to liquid water. Similarly the water formed, as steam; by

combustion is condensed to liquid water, the latent heat of condensation of the steam being recovered. In industrial practice water from both sources is discharged as steam so that both latent heat and sensible heat are lost. It is therefore useful to distinguish the calorific value as determined with the bomb calorimeter by calling it the Gross Calorific Value.

A lower value can be derived which is the gross calorific value minus the latent heat of condensation at 15.5 °C of all the water involved. This is named the Net calorific value. The net calorific value is a more realistic statement of realizable potential heat than the gross value.

The correction to the gross C.V. is 586 cal/g of water (note that latent heat of steam = 586 cal/g). The water referred to is the weight of water produced by the complete combustion of unit weight of coal plus the water existing as moisture in the coal. The former is calculated from a known hydrogen content of the coal.

Net C. V. = Gross C. V. – 586 (water as moisture + water formed from H₂) cal/g

It should be noted that the calorific value of coal has been used to exemplify gross and net calorific value. The same correction can be applied to any fuel of any physical state, care being taken with the units of weight or volume.

12. Coal burning - Environmental hazards - Measures

Coal is the least hydrogen rich of fossil fuels, meaning that more carbon is oxidized to CO₂ per gram of fuel. In spite of the fact that Coal reserves guarantee energy for over a century the path is not free from a host of environmental problems in addition to large-scale CO₂ generation that must be addressed. Emissions of NO_x from power generation using coal are an important environmental problem. NO_x contributes to the formation of photochemical smog and acid rain. HCN and NH₃ which are formed during pyrolysis of coal are assumed to be two important precursors for NO_x.

12.1. Carbon sequestration

Carbon sequestration is a new way to manage carbon. It is a provision for long-term storage of carbon in the terrestrial biosphere, underground, or the oceans so that the build up of CO₂ concentration in the atmosphere can be reduced or slowed down.

Atmospheric levels of CO₂ have risen from pre-industrial levels of 280 ppm to present levels of 375 ppm. This is because of the expanding use of fossil fuels for energy.

Continued increase in carbon emissions are suggested since world can not afford to abandon fossil fuels. But the technology ultimately going to succeed may be radically different from today's. New technologies that could capture CO₂ either at the point of emission from the power plants or from the air and dispose it of safely and permanently are under development. These approaches would make fossil fuel energy use sustainable for at least another century.

CO₂ capture from the air:

This can be accomplished by letting wind carry air over an absorber that pulls off CO₂. This could be achieved through a variety of methods, including blowing air over lime water, which will remove the CO₂ and produce lime stone. The volume of air that needs to be processed is surprisingly little when compared to the volumes required for harnessing wind energy.

12.2. CO₂ capture from power plants

The capture of CO₂ directly from power plants could be accomplished through new plant designs. Plant designs that could generate hydrogen or electricity from coal with out any emissions to the atmosphere are under development. In these methods, lime captures waste CO₂ and generates heat for additional hydrogen production. Captured CO₂ can be disposed by underground injection, a low-cost procedure whose effectiveness has been proven in enhanced oil recovery. Although underground injection will be more difficult because the demand for repositories increases this alternate method of disposal is available. Magnesium silicates can be used to react with CO₂ to form Magnesium carbonate and silica (quartz) which can be disposed safely and permanently.

Norway became the first country to impose a federal tax on atmospheric CO₂ emissions from combustion-based point sources such as coal-fired power plants. The day is not far off when other countries follow Norway's lead to protect environment and curb raising temperatures of the planet.

Development of strategies for safe disposal of CO₂ waste streams is the need of the hour.

13. Coal – From Indian perspective

Coal is the predominant energy source (58%) in India, followed by oil (27%), natural gas (7%), lignite (4%), hydropower (3%) and nuclear power (0.22%).

13.1. Coal reserves and mining

India has a long history of commercial coal mining covering nearly 230 years starting from 1774 by M/s Summer and Heatly of East India Company in the Raniganj coal field along the western bank of river Damodar.

Major coal fields in India are found in Jharkand, Bihar, West Bengal, Madhya Pradesh, Maharashtra, Assam, Andhra Pradesh, Orissa, Tamil Nadu and Kashmir. Jharia (Jharkand) and Raniganj (West Bengal) are the biggest and best coalfields of the country. Unlike the coals in Europe and America, Indian coals have high percentage of mineral matter, most of which is finely disseminated and intimately mixed with the coal substance.

Jharkand came into existence on 15th November 2000 as the 28th state of India as a result of the bifurcation of Bihar state. Nearly 32.98 % of coal deposits of India is in Jharkand. Its mines are in Jharia, Chandrapure, Bokaro, Ramgarh, Kamapur, Charhi and also in Rajmahal and Daltonganj area.

Raniganj coal field is the largest coalfield in India, belonging to the Gondwana Super group (Gondwana is a geological term which refers to a certain rock system which is about 200 million years old. Most of the Indian coals belong to this group.). Mining in this region dates back to the British period. Unfortunately there are frequent coal-fires reported from this region and India is losing good quality coal prior to its exploitation by spontaneous combustion. Hence there is need for detection and monitoring of coal-fires in coal fields in order to control them effectively.

Lignite is found mainly at Neyveli in Tamil Nadu. Minor coal fields exist in Andhra Pradesh, Kashmir and Assam. Assam coals have very high sulphur content (3-8 %). Kashmir coals are artificial anthracite converted from lignite deposits. Coal deposits of the Tertiary era (60 million years old) are found in Assam, Rajasthan and Jammu.

14. Conclusion

The time will inevitably come when there will be no more coal and no more petroleum for the rate at which the reserves are being consumed. Before the disappearance of coal and petroleum from every day life, mankind must develop a new source of power or perish. Nuclear energy appears to be a ray of hope even though it requires mutual cooperation between people world wide in terms of fuel supply and distribution apart

from the intricacies in technological advancement. It is evident that Uranium and Thorium reserves world wide can match with the man's ever quenching thirst for energy. Apart from Nuclear Energy, renewable sources such as water, wind and sunlight can also be thought of as energy sources for future even though in no way they can serve the needs of common man in the near 100 years of time from now in spite of the toiling efforts of scientists in this sector.

References

1. Richard Eisenberg and Daniel G. Nocera, *Inorg. Chem.* 2005, 44, 6799.
2. Jillian L. Dempsey, Arthur J. Esswein, David R. Manke, Joel Rosenthal, Jake D. Soper and Daniel G. Nocera, *Inorg. Chem.* 2005, 44, 6879.
3. R. Narayan and B. Viswanathan, *Chemical and Electrochemical Energy Systems*, University Press, 1998.
4. Harold H. Schobert, *The Chemistry of Hydrocarbon Fuels*, Butterworths & Co (Publishers) Ltd, 1990.
5. O. P. Gupta, *Elements of Fuels, Furnaces and Refractories*, Khanna Publishers, 1997.
6. J. C. Macrae, *An Introduction to the study of fuel*, Elsevier Publishing Company, 1966.
7. J. S. S. Brame and J. G. King, Fifth Edition, Rewritten by J. G. King, *Fuel - Solid, Liquid and Gaseous*, Edward Arnold (Publishers) Ltd, Fifth Edition, 1955.
8. Bernard R. Cooper, *Scientific Problems of Coal Utilization*, Proceedings of a conference at west Virginia Univeristy, May 23-25, 1977, Technical Information Centre, U. S. Department of Energy, 1978.
9. Mrion L. Shepard, Jack B. Chaddock, Franklin H. Cocks, Charles M. Harman *Introduction to Energy Technology*, Ann Arbor Science Publishers Inc, 1976.
10. James Lee Johnson, *Kinetics of Coal Gasification*, John Wiley & Sons, 1979.
11. H. H. Lowry, *Chemistry of Coal Utilization, Supplementary Volume*, John Wiley & Sons, Inc, 1963.
12. G. R. Gavalas, *Coal Pyrolysis, Coal Science and Technology, Volume 4* Elsevier Scientific Publishing Company, 1982.

13. E. J. Badin, Coal Combustion Chemistry – Correlation Aspects, Coal Science and Technology, Volume 6, Elsevier Scientific Publishing Company, 1984.
14. A. Volborth, Coal science and chemistry, Coal science and Technology volume 10, Elsevier Scientific Publishing Company, 1987.
15. Tapas Ranjan Martha, A. Bhattacharya, K. Vinod Kumar, Current Science, 88, No.1, 21, 2005.
16. E. Shoko, B. McLellan, A. L. Dicks, J. C. Diniz da Costa, International Journal of Coal Geology 65(2006)213.
17. A. Verma, A. D. Rao, G. S. Samuelsen, Journal of Power Sources, 158 (2006) 417
18. <http://forums.delphiforums.com/chemedu>

Chapter - 5

NUCLEAR FISSION

J. Rajeswari

1. Introduction

Energy, 'the ability to do work', is essential for meeting basic human needs, extending life expectancy and providing comfort in living standards. Energy can be considered in two categories - primary and secondary. Primary energy is energy in the form of natural resources, such as wood, coal, oil, natural gas, natural uranium, wind, hydro power, and sunlight. Secondary energy is the more useable forms to which primary energy may be converted, such as electricity and petrol. Primary energy can be renewable or non-renewable: Renewable energy sources include solar, wind and wave energy, biomass (wood or crops such as sugar), geothermal energy and hydro power. Non-renewable energy sources include the fossil fuels - coal, oil and natural gas, which together provide 80% of our energy today, plus uranium. The advantages and disadvantages of using nuclear power are given in Table 1.

Table 1. Advantages and disadvantages of nuclear power

Advantages	Disadvantages
Nuclear power costs about the same as coal, so it's not expensive to make.	Although not much waste is produced, it is dangerous. It must be sealed up and buried for many years to allow the radioactivity to die away
Does not produce smoke or carbon dioxide, so it does not contribute to greenhouse effect.	Nuclear power is reliable, but a lot of money has to be spent on safety – if it does go wrong, a nuclear accident can be a major disaster
Produces huge amounts of energy from small amounts of fuel.	
Produces small amounts of waste	
Nuclear power is reliable	

To understand the concepts of nuclear reactions, some basic terminologies have to be understood first. So, the outline of the chapter includes:

- (i) Definition of some important terminologies,
- (ii) Correlation of binding energy and nuclear fission,
- (iii) Definition of nuclear fission and chain reaction,
- (iv) Controlled nuclear reaction in nuclear reactors, types of nuclear reactors and
- (v) Uncontrollable fission reactions and atom bombs.

2. The nucleus and its constituents

An atom consists of a centrally located nucleus surrounded by electrons revolving in certain physically permitted orbitals. The nucleus itself is made up of neutrons and protons, collectively called nucleons. The number of protons (Z) is called the atomic number and the total number (A) of nucleons in a nucleus is called the atomic (or nuclear) mass number. The number of neutrons ($A-Z$) is represented as N . The basic properties of the atomic constituents are summarized in Table 2

Table 2. Properties of atomic constituents

Fundamental particle	Charge	Mass (u)
Proton	e	1.007276
Neutron	0	1.008665
Electron	$-e$	0.000549

2. a. Charge:

Protons have a positive charge of magnitude $e = 1.6022 \times 10^{-19}$ C (Coulombs) equal and opposite to that of the electron. Neutrons are uncharged. Thus, a neutral atom (A, Z) contains Z electrons and can be written symbolically as ${}^A X_N$.

2. b. Mass:

Nuclear and atomic masses are expressed in atomic mass units (u), based on the definition that the mass of a neutral atom of ${}^{12}\text{C}_6$ is exactly 12.000 u ($1 \text{ u} = 1.6605 \times 10^{-27}$ kg).

2. c. Isotopes, isotones and isobars

Atoms are classified as isotopes, isotones, and isobars based on the nuclear contents. Isobars of an element are atoms whose nuclei have the same Z but different N . They have similar electron structure and, therefore, similar chemical properties. For example, hydrogen has three isotopes: $^1\text{H}_0$, $^2\text{H}_1$, $^3\text{H}_2$ whose nuclei are respectively, the proton p , the deuteron d , and the triton t . Nuclei with the same N and different Z are called isotones, and nuclides with the same mass number A are known as isobars. In a symbolic representation of a nuclear species, or nuclide, it is usual to omit the N and Z subscripts and include only the mass number as superscript, since $A = N + Z$ and the symbol representing the chemical element uniquely specifies Z .

2. d. Mass Defect and Binding energy

Careful measurements have shown that the mass of a particular atom is always slightly less than the sum of the masses of the individual neutrons, protons, and electrons of which the atom consists. The difference between the mass of the atom and the sum of the masses of its parts is called the *mass defect* (Δm). The mass defect can be calculated using equation

$\Delta m = [Z(m_p + m_e) + (A-Z)m_n] - m_{\text{atom}}$ where: Δm = mass defect (amu), m_p = mass of a proton (1.007277 amu), m_n = mass of a neutron (1.008665 amu), m_e = mass of an electron (0.000548597 amu), m_{atom} = mass of nuclide $^A_Z X$ (amu), Z = atomic number (number of protons) and A = mass number (number of nucleons).

In calculating the mass defect it is important to use the full accuracy of mass measurements because the difference in mass is small compared to the mass of the atom. Rounding off the masses of atoms and particles to three or four significant digits prior to the calculation will result in a calculated mass defect of zero.

2. e. Binding energy

Binding energy is the amount of energy that must be supplied to a nucleus to completely separate its nuclear particles. Binding energy is the energy equivalent of the mass defect. Binding energy can be calculated by multiplying the mass defect by the factor of 931.5 MeV per amu.

2. f. Binding energy and nuclear stability

As the number of particles in a nucleus increases, the total binding energy also increases. The rate of increase, however, is not uniform. This lack of uniformity results in a

variation in the amount of binding energy associated with each nucleon within the nucleus. This variation in the binding energy per nucleon (BE/A) is easily seen when the average BE/A is plotted versus atomic mass number (A), as shown in Fig.1.

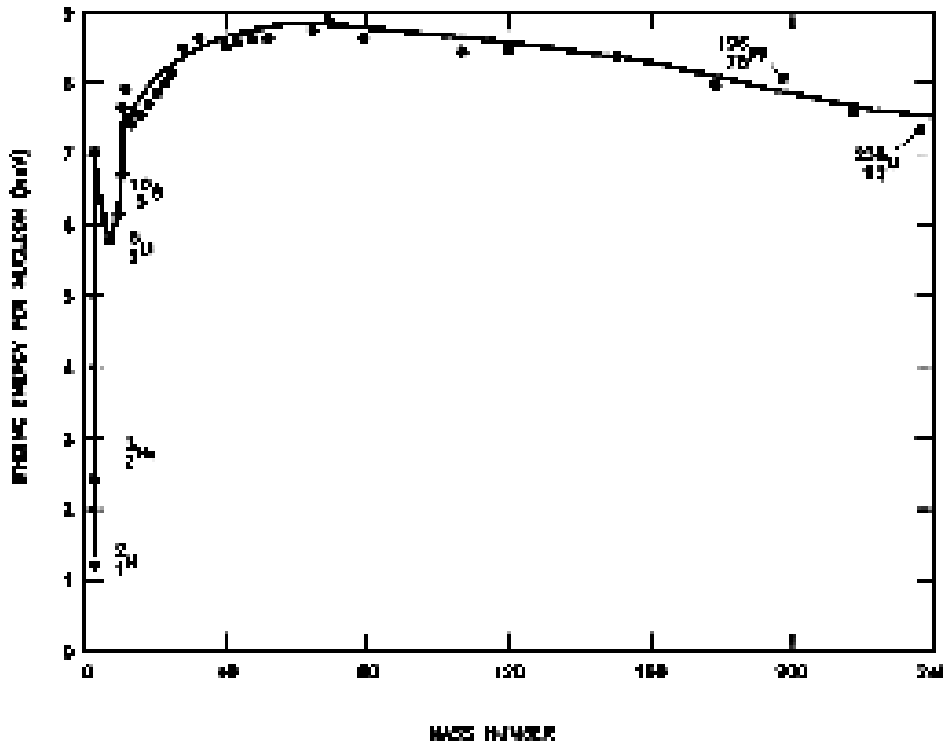

Fig.1. Nuclear binding energy curve

Fig.1. illustrates that as the atomic mass number increases, the binding energy per nucleon decreases for $A > 60$. The BE/A curve reaches a maximum value of 8.79 MeV at $A = 56$ and decreases to about 7.6 MeV for $A = 238$. The general shape of the BE/A curve can be explained using the general properties of nuclear forces. The nucleus is held together by very short-range attractive forces that exist between nucleons. On the other hand, the nucleus is being forced apart by long range repulsive electrostatic (coulomb) forces that exist between all the protons in the nucleus.

As the atomic number and the atomic mass number increase, the repulsive electrostatic forces within the nucleus increase due to the greater number of protons in the heavy elements. To overcome this increased repulsion, the proportion of neutrons in the nucleus must increase to maintain stability. This increase in the neutron-to-

proton ratio only partially compensates for the growing proton-proton repulsive force in the heavier, naturally occurring elements. Because the repulsive forces are increasing, less energy must be supplied, on the average, to remove a nucleon from the nucleus. The BE/A has decreased. The BE/A of a nucleus is an indication of its degree of stability. Generally, the more stable nuclides have higher BE/A than the less stable ones. The increase in the BE/A as the atomic mass number decreases from 260 to 60 is the primary reason for the energy liberation in the fission process. In addition, the increase in the BE/A as the atomic mass number increases from 1 to 60 is the reason for the energy liberation in the fusion process, which is the opposite reaction of fission.

The heaviest nuclei require only a small distortion from a spherical shape (small energy addition) for the relatively large coulomb forces forcing the two halves of the nucleus apart to overcome the attractive nuclear forces holding the two halves together. Consequently, the heaviest nuclei are easily fissionable compared to lighter nuclei.

3. Radiation and Nuclear Reactions

Traditional chemical reactions occur as a result of the interaction between valence electrons around an atom's nucleus. In 1896, Henri Becquerel expanded the field of chemistry to include nuclear changes when he discovered that uranium emitted radiation. Soon after Becquerel's discovery, Marie Sklodowska Curie began studying radioactivity and carried out much of the pioneering work on nuclear changes. Curie found that radiation was proportional to the amount of radioactive element present, and she proposed that radiation was a property of atoms (as opposed to a chemical property of a compound).

In 1902, Frederick Soddy proposed the theory that 'radioactivity is the result of a natural change of an isotope of one element into an isotope of a different element'. Nuclear reactions involve changes in particles in an atom's nucleus and thus cause a change in the atom itself. All elements heavier than bismuth (Bi) (and some lighter) exhibit natural radioactivity and thus can 'decay' into lighter elements. Unlike normal chemical reactions that form molecules, nuclear reactions result in the transmutation of one element into a different isotope or a different element altogether (the number of protons in an atom

defines the element, so a change in protons results in a change in the atom). There are three common types of radiation and nuclear changes:

3. a. Alpha Radiation (α) is the emission of an alpha particle from an atom's nucleus. An α particle contains 2 protons and 2 neutrons (and is similar to a He nucleus: ${}^4_2\text{He}$). When an atom emits an α particle, the atom's atomic mass will decrease by 4 units (because 2 protons and 2 neutrons are lost) and the atomic number (z) will decrease by 2 units. The element is said to 'transmute' into another element that is 2 units of z smaller. An example of an α transmutation takes place when uranium decays into the element thorium (Th) by emitting an alpha particle as depicted in the following equation:

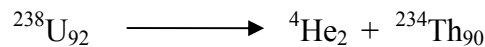

3.b. Beta Radiation (β) is the transmutation of a neutron into a proton and a electron (followed by the emission of the electron from the atom's nucleus: ${}_{-1}^0\text{e}$). When an atom emits a β particle, the atom's mass will not change (since there is no change in the total number of nuclear particles), however the atomic number will increase by 1 (because the neutron transmuted into an additional proton). An example of this is the decay of the isotope of carbon named carbon-14 into the element nitrogen:

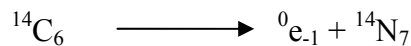

3. c. Gamma Radiation (γ) involves the emission of electromagnetic energy (similar to light energy) from an atom's nucleus. No particles are emitted during gamma radiation, and thus gamma radiation does not itself cause the transmutation of atoms, however γ radiation is often emitted during, and simultaneous to, α or β radioactive decay. X-rays, emitted during the beta decay of cobalt-60, are a common example of gamma radiation:

3. d. Half-life

Radioactive decay proceeds according to a principal called the half-life. The half-life ($T_{1/2}$) is the amount of time necessary for $\frac{1}{2}$ of the radioactive material to decay. For example, the radioactive element bismuth (${}^{210}\text{Bi}$) can undergo alpha decay to form the element thallium (${}^{206}\text{Tl}$) with a reaction half-life equal to 5 days. If we begin an experiment starting with 100g of bismuth in a sealed lead container, after 5 days we will

have 50g of bismuth and 50g of thallium in the jar. After another 5 days (10 from the starting point), $\frac{1}{2}$ of the remaining bismuth will decay and we will be left with 25g of bismuth and 75g of thallium in the jar.

The fraction of parent material that remains after radioactive decay can be calculated using the equation:

$$\text{Fraction remaining} = 1/2^n \text{ where } n = \text{half-lives elapsed}$$

The amount of a radioactive material that remains after a given number of half-lives is therefore:

$$\text{Amount remaining} = \text{original amount} \times \text{fraction remaining}$$

The decay reaction and $T_{1/2}$ of a substance are specific to the isotope of the element undergoing radioactive decay. For example, ^{210}Bi can undergo α decay to ^{206}Tl with a $T_{1/2}$ of 5 days. ^{215}Bi , by comparison, undergoes β decay to ^{215}Po with a $T_{1/2}$ of 7.6 minutes, and ^{208}Bi undergoes yet another mode of radioactive decay (called electron capture) with a $T_{1/2}$ of 368,000 years!

4. Nuclear fission

Though many elements undergo radioactive decay naturally, nuclear reactions can also be stimulated artificially. Although these reactions occur naturally, we are most familiar with them as stimulated reactions. There are 2 such types of nuclear reactions: nuclear fission and nuclear fusion. This chapter deals exclusively with nuclear fission reaction. Nuclear Fission denotes reactions in which an atom's nucleus splits into smaller parts, releasing a large amount of energy in the process (Fig.2). Most commonly, this is done by 'firing' a neutron at the nucleus of an atom. The energy of the neutron 'bullet' causes the target element to split into 2 (or more) elements that are lighter than the parent atom. When a nucleus undergoes fission, it splits into several smaller fragments. These fragments, or fission products, are about equal to half the original mass. Two or three neutrons are also emitted. The sum of the masses of these fragments is less than the original mass. This 'missing' mass (about 0.1 percent of the original mass) has been converted into energy according to Einstein's equation.

Fission can occur when a nucleus of a heavy atom captures a neutron, or it can happen spontaneously.

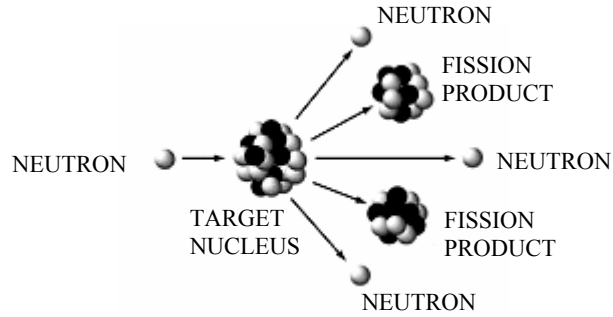

Fig.2. Nuclear Fission

4. a. Chain Reaction

A chain reaction refers to a process in which neutrons released in fission produce an additional fission in at least one further nucleus. This nucleus in turn produces neutrons, and the process repeats (Fig.3). The process may be controlled (nuclear power) or uncontrolled (nuclear weapons).

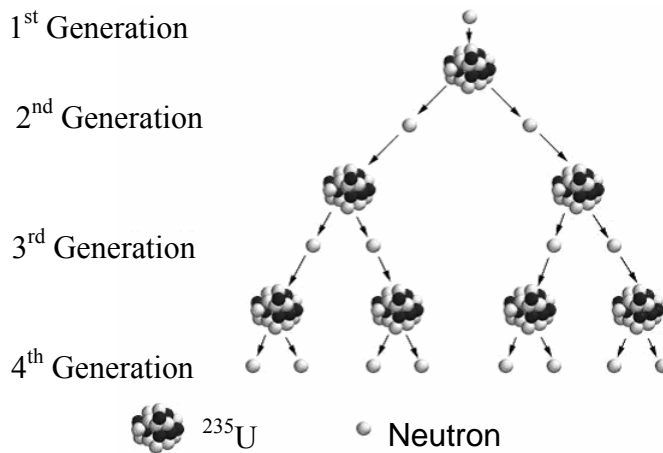
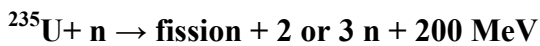

Fig.3. Nuclear chain reaction



If each neutron releases two more neutrons, then the number of fission doubles each generation. In that case, in 10 generations there are 1,024 fissions and in 80 generations about 6×10^{23} (a mole) fissions.

4. b. Critical Mass

Although two to three neutrons are produced for each fission, not all of these neutrons are available for continuing the fission reaction. If the conditions are such that the neutrons are lost at a faster rate than they are formed by fission, the chain reaction will not be self-sustaining. At the point where the chain reaction can become self-sustaining, this is referred to as critical mass. In an atomic bomb, a mass of fissile material greater than the critical mass must be assembled instantaneously and held together for about a millionth of a second to permit the chain reaction to propagate before the bomb explodes. The amount of a fissionable material's critical mass depends on several factors; the shape of the material, its composition and density, and the level of purity. A sphere has the minimum possible surface area for a given mass, and hence minimizes the leakage of neutrons. By surrounding the fissionable material with a suitable neutron "reflector", the loss of neutrons can be reduced and the critical mass can be reduced. By using a neutron reflector, only about 11 pounds (5 kilograms) of nearly pure or weapon's grade plutonium 239 or about 33 pounds (15 kilograms) uranium 235 is needed to achieve critical mass.

4. c. U-235 and U-238

Uranium, which is used in nuclear power generation, includes U-235 and U-238. These two isotopes of uranium, almost like twins, differ only in the number of their neutrons. When a U-235 atom absorbs a neutron, it loses stability, which causes nuclear fission. Nuclear power generation utilizes thermal energy emitted at the time of nuclear fission. A U-238 nucleus, on the other hand, does not split when a neutron is absorbed; instead U-238 changes into plutonium 239.

4. d. Uranium Enrichment

The concentration of U-235, with which nuclear fission occurs, is increased from approximately 0.7% to 3-5%. Enrichment methods include the gaseous diffusion process, the laser enrichment method, and the centrifuge process.

4. e. Controlled Nuclear Fission and Nuclear Reactors

To maintain a sustained controlled nuclear reaction, for every 2 or 3 neutrons released, only one must be allowed to strike another uranium nucleus (Fig.4). If this ratio is less than one then the reaction will die out; if it is greater than one it will grow uncontrolled (an atomic explosion). A neutron absorbing element must be

present to control the amount of free neutrons in the reaction space. Most reactors are controlled by means of control rods that are made of a strongly neutron-absorbent material such as boron or cadmium.

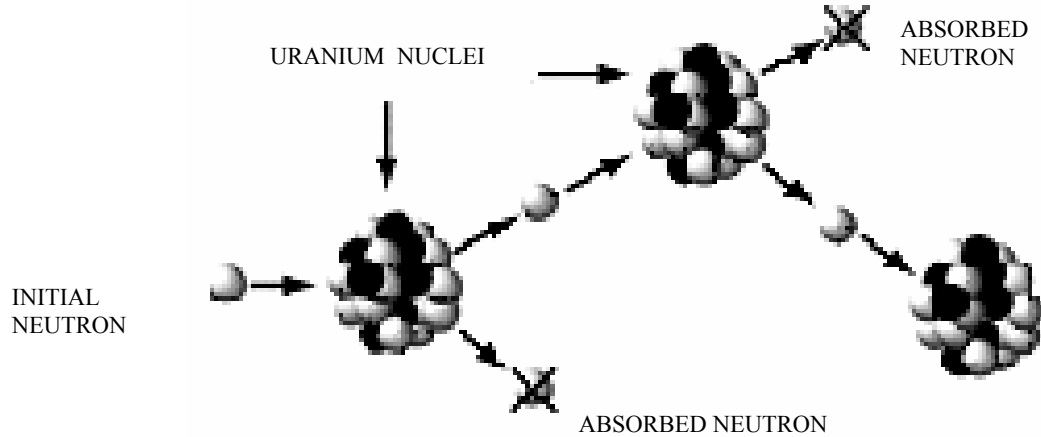

Fig.4. Controlled Nuclear fission

There are different types of nuclear reactors such as pressurized water reactor (Fig.5), boiling water reactor, gas cooled reactor, pressurized heavy water reactor, light water graphite reactor and so on. Most are used for power generation, but some can also produce plutonium for weapons and fuel. Two components are common to all reactors, control rods and a coolant. **Control rods** determine the rate of fission by regulating the number of neutrons. These rods consist of neutron-absorbing elements such as boron. These are made with neutron-absorbing material such as cadmium, hafnium or boron, and are inserted or withdrawn from the core to control the rate of reaction, or to halt it. (Secondary shutdown systems involve adding other neutron absorbers, usually as a fluid, to the system.) The **coolant** removes the heat generated by fission reactions. Water is the most common coolant, but pressurized water, helium gas, and liquid sodium have been used. In light water reactors the moderator functions also as coolant.

In addition to the need to capture neutrons, the neutrons often have too much kinetic energy. These fast neutrons are slowed through the use of a moderator such as heavy water and ordinary water. Some reactors use graphite as a moderator, but this design has several problems. Once the fast neutrons have been slowed, they are more likely to produce further nuclear fissions or be absorbed by the control rod.

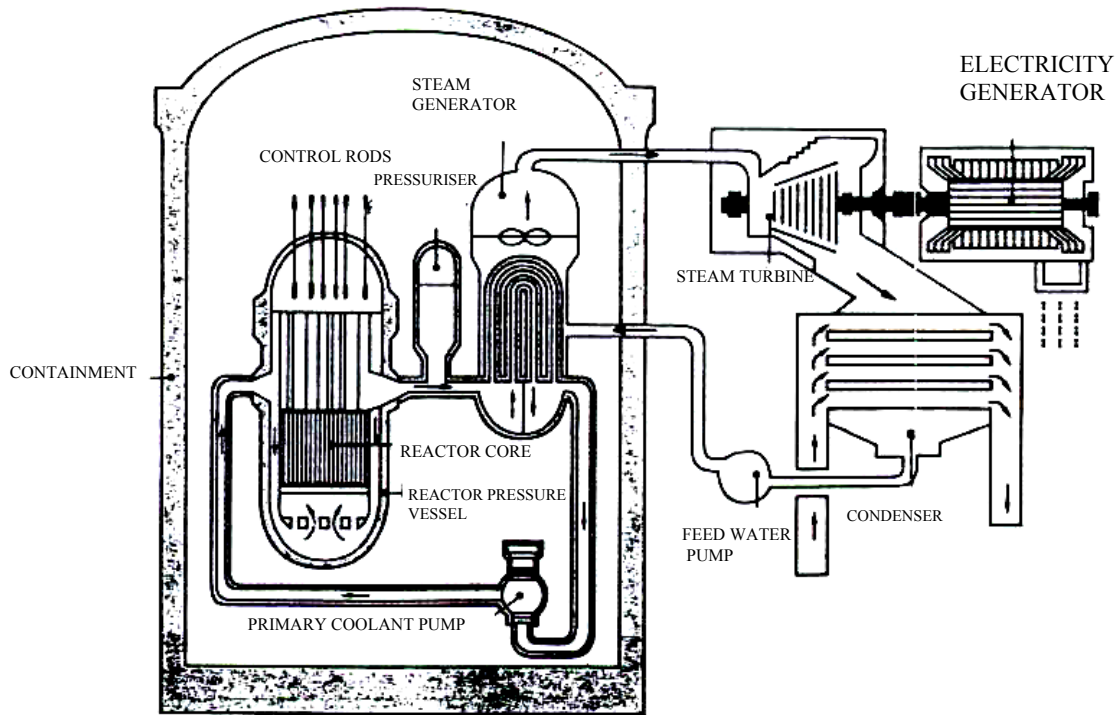

Fig.5. Pressurized water reactor

Slow-neutron reactors operate on the principle that uranium-235 undergoes fission more readily with thermal or slow neutrons. Therefore, these reactors require a **moderator** to slow neutrons from high speeds upon emerging from fission reactions. The most common moderators are graphite (carbon), light water (H_2O), and heavy water (D_2O). Since slow reactors are highly efficient in producing fission in uranium-235, slow-neutron reactors operate with natural or slightly enriched uranium. Light-water reactors are classified as either pressurized-water reactors (PWR) or boiling-water reactors (BWR), depending on whether the coolant water is kept under pressure or not. The long time periods, typically 12 to 18 months, between refueling of light-water reactors make it difficult to use them as a source of plutonium.

5. Fast Breeder Reactor

The fast breeder or fast breeder reactor (FBR) is a fast neutron reactor designed to breed fuel by producing more fissile material than it consumes. They are supposed to minimize

the nuclear wastes. The FBRs usually use a mixed oxide fuel core of up to 20% plutonium dioxide (PuO_2) and at least 80% uranium dioxide (UO_2). The plutonium used can be from reprocessed civil or dismantled nuclear weapons sources. Surrounding the reactor core is a blanket of tubes containing non-fissile uranium-238 which, by capturing fast neutrons from the reaction in the core, is partially converted to fissile plutonium 239 (as is some of the uranium in the core), which can then be reprocessed for use as nuclear fuel. No moderator is required as the reactions proceed well with fast neutrons. Early FBRs used metallic fuel, either highly enriched uranium or plutonium.

Fast reactors typically use liquid metal as the primary coolant, to cool the core and heat the water used to power the electricity generating turbines. Sodium is the normal coolant for large power stations, but lead and Na-K have both been used successfully for smaller generating rigs. Some early FBRs used mercury. One advantage of mercury and Na-K is that they are both liquids at room temperature, which is convenient for experimental rigs but less important for pilot or full scale power stations. At its best, the Breeder Reactor system produces no nuclear waste whatever - literally everything eventually gets used. In the real world, there actually may be some residual material that could be considered waste, but its half-life - the period of time it takes for half the radioactivity to dissipate - is of the order of thirty to forty years.

India has an active development programme featuring both fast and thermal breeder reactors. India's first 40 MWt Fast Breeder Test Reactor (FBTR) attained criticality on 18th October 1985. Thus India becomes the sixth nation having the technology to built and operate a FBTR after US, UK, France, Japan and the former USSR. India has developed and mastered the technology to produce the plutonium rich U-Pu mixed carbide fuel. This can be used in the Fast Breeder Reactor. India has consciously proceeded to explore the possibility of tapping nuclear energy for the purpose of power generation and the Atomic Energy Act was framed and implemented with the set objectives of using two naturally occurring elements Uranium and Thorium having good potential to be utilized as nuclear fuel in Indian Nuclear Power Reactors. The estimated natural deposits of these elements in India are:

- Natural Uranium deposits - ~70,000 tonnes
- Thorium deposits - ~ 3,60,000 tonnes

Indian nuclear power generation envisages a three stage program. Stage 1 has natural uranium dioxide as fuel matrix and heavy water as both coolant and moderator. In this stage, U-235 gives several fission products and tremendous amount of energy and U-238 gives Pu-239. India's second stage of nuclear power generation envisages the use of Pu-239 (main fissile material in stage 2) obtained from the first stage reactor operation, as the fuel core in fast breeder reactors. A blanket of U-238 surrounding the fuel core will undergo nuclear transmutation to produce fresh Pu-239 as more and more Pu-239 is consumed during the operation. Besides a blanket of Th-232 around the FBR core also undergoes neutron capture reactions leading to the formation of U-233. U-233 is the nuclear reactor fuel for the third stage of India's Nuclear Power Programme. It is technically feasible to produce sustained energy output of 420 GWe from FBR. The third phase of India's Nuclear Power Generation programme is, breeder reactors using U-233 fuel. India's vast thorium deposits permit design and operation of U-233 fuelled breeder reactors. U-233 is obtained from the nuclear transmutation of Th-232 used as a blanket in the second phase Pu-239 fuelled FBR. Besides, U-233 fuelled breeder reactors will have a Th-232 blanket around the U-233 reactor core which will generate more U-233 as the reactor goes operational thus resulting in the production of more and more U-233 fuel from the Th-232 blanket as more of the U-233 in the fuel core is consumed helping to sustain the long term power generation fuel requirement. These U-233/Th-232 based breeder reactors are under development and would serve as the mainstay of the final thorium utilization stage of the Indian nuclear programme. The currently known Indian thorium reserves amount to 358,000 GWe-yr of electrical energy and can easily meet the energy requirements during the next century and beyond.

6.From Fission to Electricity

Nuclear power is the controlled use of nuclear reactions (currently limited to nuclear fission and radioactive decay) to do useful work including propulsion, heat, and the generation of electricity. Nuclear energy is produced when a fissile material, such as uranium-235, is concentrated such that the natural rate of radioactive decay is accelerated in a controlled chain reaction and creates heat - which is used to boil water, produce steam, and drive a steam turbine. The turbine can be used for mechanical work and also to generate electricity.

During the fission of U-235, 3 neutrons are released in addition to the two daughter atoms. If these released neutrons collide with nearby U235 nuclei, they can stimulate the fission of these atoms and start a self-sustaining nuclear chain reaction. This chain reaction is the basis of nuclear power. As uranium atoms continue to split, a significant amount of energy is released from the reaction. The heat released during this reaction is harvested and used to generate electrical energy. A nuclear power plant produces electricity in almost exactly the same way that a conventional (fossil fuel) power plant does. A conventional power plant burns fuel to create heat. The fuel is generally coal, but oil is also sometimes used. The heat is used to raise the temperature of water, thus causing it to boil. The high temperature and intense pressure steam those results from the boiling of the water turns a turbine, which then generates electricity. A nuclear power plant works the same way, except that the heat used to boil the water is produced by a nuclear fission reaction using ^{235}U as fuel, not the combustion of fossil fuels. A nuclear power plant uses less fuel than a comparable fossil fuel plant. A rough estimate is that it takes 17,000 kilograms of coal to produce the same amount of electricity as 1 kilogram of nuclear uranium fuel.

7. *Spontaneous Nuclear Fission – Nuclear weapons*

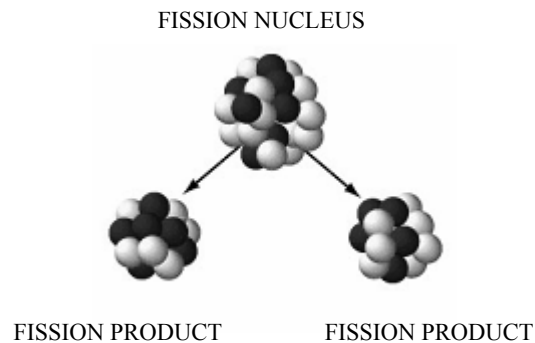

Fig.6. Spontaneous nuclear fission

The spontaneous nuclear fission rate (Fig.6) is the probability per second that a given atom will fission spontaneously, that is, without any external intervention. If a spontaneous fission occurs before the bomb is fully ready, it could fizzle. Plutonium 239 has a very high spontaneous fission rate compared to the spontaneous fission rate of uranium 235. Scientists had to consider the spontaneous fission rate of each material

when designing nuclear weapons. Nuclear weapon is a weapon which derives its destructive force from nuclear reactions of either nuclear fission or the more powerful fusion. Nuclear weapons have been used only twice, both during the closing days of World War II. The first event occurred on the morning of 6 August 1945, when the United States dropped a uranium gun-type device code-named "Little Boy" on the Japanese city of Hiroshima. The second event occurred three days later when a plutonium implosion-type device code-named "Fat Man" was dropped on the city of Nagasaki. In fission weapons, a mass of fissile material (enriched uranium or plutonium) is rapidly assembled into a supercritical mass by shooting one piece of sub-critical material into another or compressing a sub-critical mass, usually with chemical explosives. Neutrons are then injected to start a chain reaction that grows rapidly and exponentially, releasing tremendous amounts of energy. A major challenge in all nuclear weapon designs is ensuring that a significant fraction of the fuel is consumed before the weapon destroys itself.

7. a. Little Boy: A Gun-Type Bomb

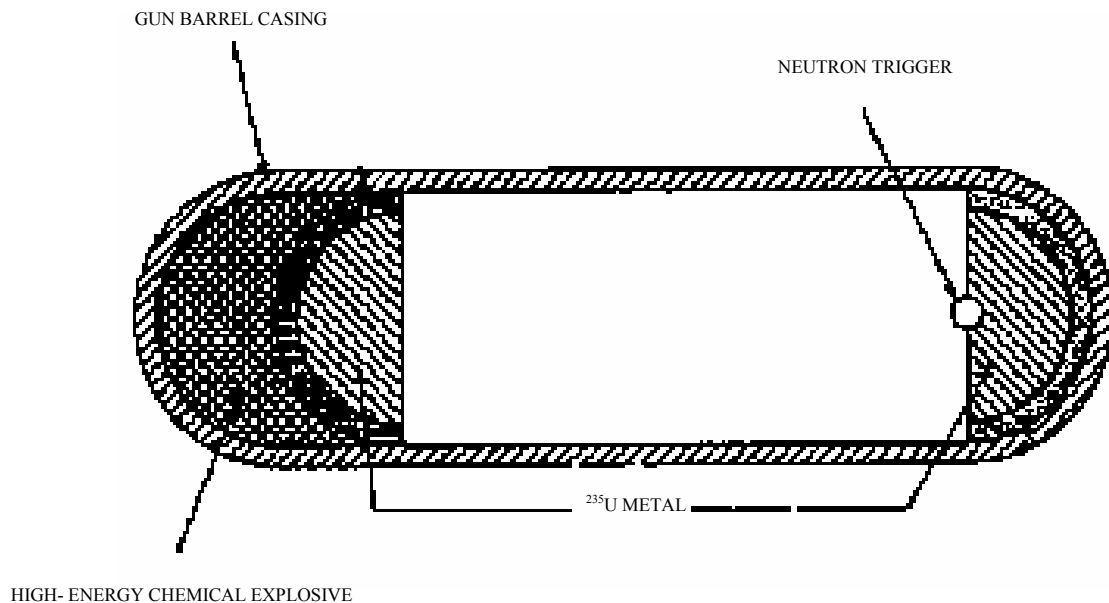

Fig.7. little boy – first nuclear weapon

In essence, the Little Boy design (Fig.7) consisted of a gun that fired one mass of uranium 235 at another mass of uranium 235, thus creating a supercritical mass. A crucial requirement was that the pieces be brought together in a time shorter than the

time between spontaneous fissions. Little Boy was the first nuclear weapon used in warfare. Once the two pieces of uranium are brought together, the initiator introduces a burst of neutrons and the chain reaction begins, continuing until the energy released becomes so great that the bomb simply blows itself apart.

7. B. Time of Reaction

The released neutron travels at speeds of about 10 million meters per second, or about 3% the speed of light. The characteristic time for a generation is roughly the time required to cross the diameter of the sphere of fissionable material. A critical mass of uranium is about the size of a baseball (0.1 meters). The time, T , the neutron would take to cross the sphere is:

$$T = 0.1 \text{ m} / 1 \times 10^7 \text{ ms}^{-1} = 1 \times 10^{-8} \text{ sec}$$

The complete process of a bomb explosion is about 80 times this number, or about a microsecond.

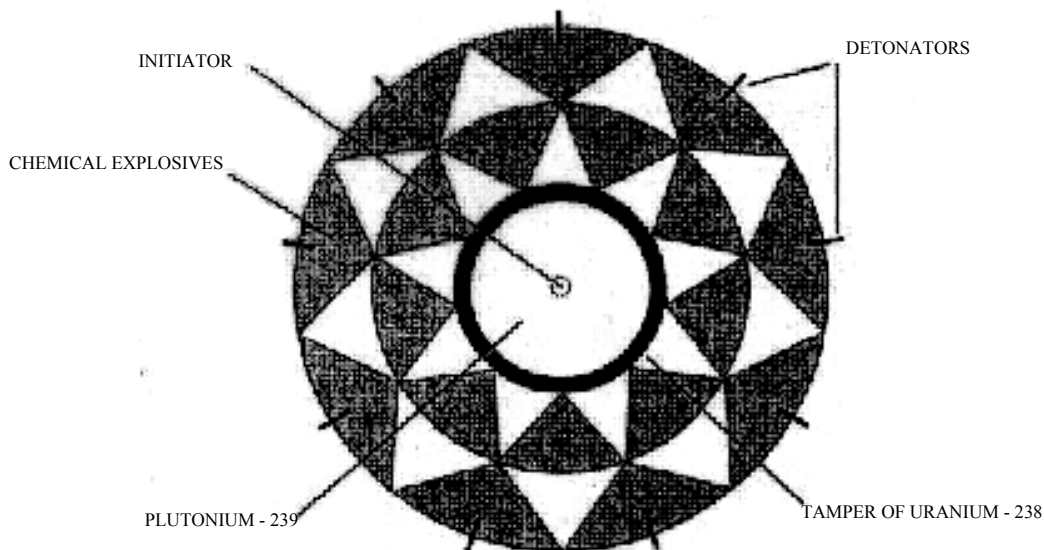

Fig.8. Implosion type bomb (the second nuclear weapon)

7. d. Fat Man: Implosion-Type Bomb

"Fat-Man"(Fig.8) was the codename of the atomic bomb which was detonated over Nagasaki, Japan by the United States, on August 9, 1945. It was the second of the two nuclear weapons to be used in warfare. The initial design for the plutonium

bomb was also based on using a simple gun design (known as the "Thin Man") like the uranium bomb. As the plutonium was produced in the nuclear reactors at Hanford, Washington, it was discovered that the plutonium was not as pure as the initial samples from Lawrence's Radiation Laboratory. The plutonium contained amounts of plutonium 240, an isotope with a rapid spontaneous fission rate. This necessitated that a different type of bomb be designed. A gun-type bomb would not be fast enough to work. Before the bomb could be assembled, a few stray neutrons would have been emitted from the spontaneous fissions, and these would start a premature chain reaction, leading to a great reduction in the energy released.

References:

1. J. Lilley, Nuclear Physics, John Wiley & Sons, Chichester (2001).
2. K. S. Krane, Introductory Nuclear Physics, John Wiley & Sons, New York (1998).
3. M. N. Sastri, Introduction to Nuclear Science, Affiliated East – West Press Private Limited, New Delhi (1983).
4. www.uic.com
5. http://en.wikipedia.org/wiki/Nuclear_power
6. http://www.visionlearning.com/library/module_viewer.php?mid=59
7. <http://www.barc.ernet.in/webpages/about/anu1.htm>

Chapter – 6

NUCLEAR FUSION

P. Satyananda Kishore

1. Introduction

Why there is a need for alternative energy resources derived from nuclear reactions?

The World, particularly developing countries, needs a New Energy Source because of

- Growth in world population and growth in energy demand from increased industrialization/affluence which will lead to an Energy Gap that will be increasingly difficult to fulfill with fossil fuels
- Without improvements in efficiency we will need 80% more energy by 2020
- Even with efficiency improvements at the limit of technology we would still need 40% more energy

Incentives for Developing Fusion

- Fusion powers the Sun and the stars
 - It is now within reach for use on Earth
- In the fusion process lighter elements are “fused” together, making heavier elements and producing prodigious amounts of energy
- Fusion offers very attractive features:
 - Sustainable energy source
 - No emission of Greenhouse or other polluting gases
 - No risk of a severe accident
 - No long-lived radioactive waste
- Fusion energy can be used to produce electricity and hydrogen, and for desalination

Fusion produces radio active waste volumes more than fission but much less than coal for power plants of equal size.

2. Nuclear Fusion

Nuclear fusion is the process by which two nuclei join together to form a heavier nucleus. It is accompanied by the release or absorption of energy depending on the masses of the nuclei involved. Iron and nickel nuclei have the largest binding energies per nucleon of

all nuclei and therefore are the most stable. The fusion of two nuclei lighter than iron or nickel generally releases energy while the fusion of nuclei heavier than them absorbs energy.

Nuclear fusion of light elements releases the energy that causes stars to shine and hydrogen bombs to explode. Nuclear fusion of heavy elements (absorbing energy) occurs in the extremely high-energy conditions of supernova explosions. Nuclear fusion in stars and supernovae is the primary process by which new natural elements are created. It is this reaction that is harnessed in fusion power. In the core of the Sun, at temperatures of 10-15 million Kelvin, Hydrogen is converted to Helium by fusion - providing enough energy to keep the Sun burning and to sustain life on Earth

A vigorous world-wide research programme is underway, aimed at harnessing fusion energy to produce electricity on Earth. If successful, this will offer a viable alternative energy supply within the next 30-40 years with significant environmental, supply and safety advantages over present energy sources

To harness fusion on Earth, different, more efficient fusion reactions than those at work in the Sun are chosen; those between the two heavy forms of Hydrogen : Deuterium (D) and Tritium (T). All forms of Hydrogen contain one proton and one electron. Protium, the common form of Hydrogen has no neutrons, Deuterium has one neutron, and Tritium has two. If forced together, the Deuterium and Tritium nuclei fuse and then break apart to form a helium nucleus (two protons and two neutrons) and an uncharged neutron. The excess energy from the fusion reaction (released because the products of the reaction are bound together in a more stable way than the reactants) is mostly contained in the free neutron.

Deuterium and/or Tritium fuse according to the following equations

- ${}^2_1\text{H} + {}^2_1\text{H} \rightarrow {}^3_2\text{He} + {}^1_0\text{n}$
- ${}^2_1\text{H} + {}^3_1\text{H} \rightarrow {}^4_2\text{He} + {}^1_0\text{n}$

Great potential for meeting our energy needs: 1 g of H₂ produces energy equivalent from burning 1 ton of coal.

Deuterium is naturally occurring and is available at 0.015% abundance. ${}^2_1\text{H}$ in water could meet energy needs for millions of years.

Tritium is radioactive and must be produced via fission of Li (abundant in earth's crust).

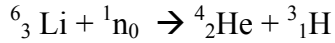

For example, 10 grams of Deuterium which can be extracted from 500 L (or 0.5 Mg) of water and 15g of Tritium produced from 30g of Lithium would produce enough fuel for the lifetime electricity needs of an average person in an industrialized country.

Sustained Fusion Requirements

- Extremely high temperatures (100 – 200 million K) at which the hydrogen isotopes are stripped of their electrons creating a plasma of hot charged gases.
- Control of plasma to confine the energy for 1-2 seconds.
- Extremely high pressure to force the cations closer than 10^{-15} m to achieve plasma density $> 2E20$ particles/m³

For potential nuclear energy sources for the Earth, the deuterium-tritium fusion reaction contained by some kind of magnetic confinement seems the most likely path. However, for the fueling of the stars, other fusion reactions will dominate.

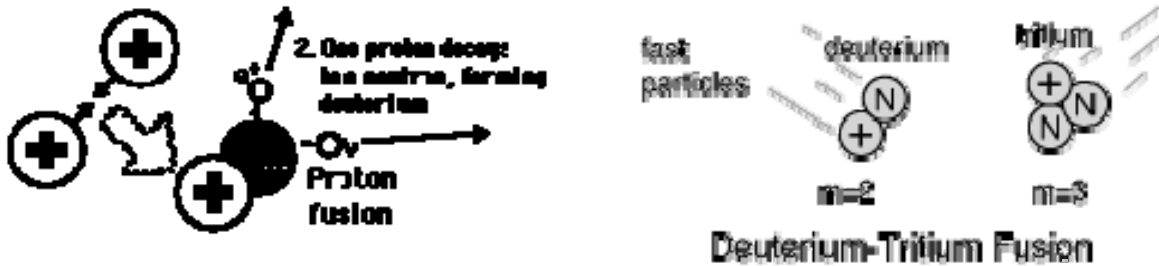

2.1. Deuterium – tritium fusion reaction:

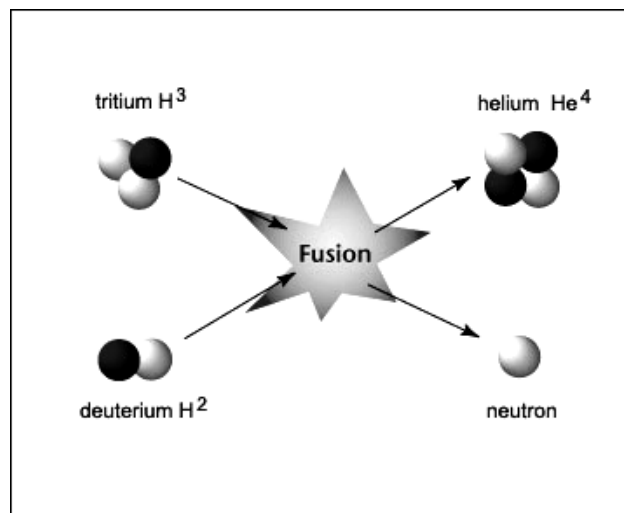
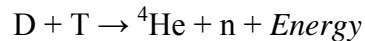

The ^4He nuclei (*'a' particles*) carry about 20% of the energy and stay in the plasma. The other 80% is carried away by the neutrons and can be used to generate steam.

It takes considerable energy to force nuclei to fuse, even those of the least massive element, hydrogen. But the fusion of lighter nuclei, which creates a heavier nucleus and a free neutron, will generally release more energy than it took to force them together — an exothermic process that can produce self-sustaining reactions.

The energy released in most nuclear reactions is larger than that for chemical reactions, because the binding energy that holds a nucleus together is far greater than the energy that holds electrons to a nucleus. For example, the ionization energy gained by adding an electron to a hydrogen nucleus is 13.6 electron volts less than one-millionth of the 17 MeV released in the D-T (deuterium-tritium) reaction .

2.2. Comparison of energies released from various processes

Fusion occurs at a sufficient rate only at very high energies (temperatures); on earth, temperatures greater than 100 million Kelvin is required. At these extreme temperatures, the Deuterium - Tritium (D-T) gas mixture becomes plasma (a hot, electrically charged gas). In plasma, the atoms become separated - electrons have been stripped from the atomic nuclei (called the "ions"). For the positively charged ions to fuse, the temperature (or energy) must be sufficient to overcome their natural charge repulsion.

	Chemical	Fission	Fusion
Reaction	$\text{C} + \text{O}_2 \rightarrow \text{CO}_2$	U-235	$^2_1\text{H} + ^2_1\text{H} \rightarrow ^3_2\text{He} + ^1_0\text{n}$
Starting Material	coal	UO ₂ ore	H-2, H-3 isotopes
Temp needed	700 K	1000 K	1E+8 K
Energy J/kg fuel	3.3E+7 or 33 MegaJ	2.1E+12 or 2000 GigaJ	3.4E+14 or 3400000 GigaJ

In order to harness fusion energy, scientists and engineers are learning how to control very high temperature plasmas. The use of much lower temperature plasmas are now widely used in industry, especially for semi-conductor manufacture. However, the control

of high temperature fusion plasmas presents several major science and engineering challenges - how to heat a plasma to in excess of 100 million Kelvin and how to confine such a plasma, sustaining it so that the fusion reaction can become established.

2.3. Conditions for a Fusion Reaction

Three parameters (plasma temperature, density and confinement time) need to be simultaneously achieved for sustained fusion to occur in plasma. The product of these is called the fusion (or triple) product and, for D-T fusion to occur, this product has to exceed a certain quantity - derived from the so-called **Lawson Criterion** after British scientist John Lawson who formulated it in 1955.

Once a critical ignition temperature for nuclear fusion has been achieved, it must be maintained at that temperature for a long enough confinement time at a high enough ion density to obtain a net yield of energy. In 1957, J. D. Lawson showed that the product of ion density and confinement time determined the minimum conditions for productive fusion, and that product is commonly called Lawson's criterion. Commonly quoted figures for this criterion are

Lawson's Criterion for fusion	$n_t \geq 10^{14} \text{ s/cm}^3$	deuterium-tritium fusion
	$n_t \geq 10^{16} \text{ s/cm}^3$	Deuterium-deuterium fusion

The closest approach to Lawson's criterion has been at the Tokamak Fusion Test Reactor (TFTR) at Princeton. It has reached ignition temperature and gotten very close to Lawson's criterion, although not at the same time.

Attaining conditions to satisfy the Lawson criterion ensures the plasma exceeds **Break even** - the point where the fusion power out exceeds the power required to heat and sustain the plasma.

2.3.1. Temperature

Fusion reactions occur at a sufficient rate only at very high temperatures - when the positively charged plasma can overcome their natural repulsive forces. Typically, in JET, over 100 million Kelvin is needed for the Deuterium-Tritium reaction to occur; other fusion reactions (e.g. D-D, D-He³) require even higher temperatures.

2.3.2. Density

The density of fuel ions (the number per cubic metre) must be sufficiently large for fusion reactions to take place at the required rate. The fusion power generated is reduced if the fuel is diluted by impurity atoms or by the accumulation of Helium ions from the fusion reaction itself. As fuel ions are burnt in the fusion process they must be replaced by new fuel and the Helium products (the "ash") must be removed.

2.3.3. Energy Confinement

The Energy Confinement Time is a measure of how long the energy in the plasma is retained before being lost. It is officially defined as the ratio of the thermal energy contained in the plasma and the power input required to maintain these conditions. Magnetic fields are used to isolate the very hot plasma from the relatively cold vessel walls in order to retain the energy for as long as possible. Losses in magnetically-confined plasma are mainly due to radiation. The confinement time increases dramatically with plasma size (large volumes retain heat better than small volumes) the ultimate example being the Sun whose energy confinement time is massive.

For sustained fusion to occur, the following plasma conditions need to be maintained (simultaneously).

* Plasma temperature: (T) 100-200 million Kelvin

* Energy Confinement Time: (t) 1-2 seconds

* Central Density in Plasma: (n) $2-3 \times 10^{20}$ particles m^{-3} (approx. $1/1000$ gram m^{-3}).

2.3.4. Magnetic plasma confinement

Since a plasma comprises charged particles : ions (positive) and electrons (negative), powerful magnetic fields can be used to isolate the plasma from the walls of the containment vessel; thus enabling the plasma to be heated to temperatures in excess of 100 million Kelvin. This isolation of the plasma reduces the conductive heat loss through the vessel and also minimizes the release of impurities from the vessel walls into the plasma that would contaminate and further cool the plasma by radiation.

In a magnetic field the charged plasma particles are forced to spiral along the magnetic field lines. The most promising magnetic confinement systems are toroidal (from torus : ring-shaped) and, of these, the most advanced is the Tokamak. Currently, JET is the largest Tokamak in the world although the future ITER machine will be even larger.

Other, non magnetic plasma confinement systems are being investigated - notably inertial confinement or laser-induced fusion systems

The plasma is heated in a ring-shaped vessel (or torus) and kept away from the vessel walls by the applied magnetic fields. The basic components of magnetic confinement system are:-

- The toroidal field - which produces a field around the torus. This is maintained by magnetic field coils surrounding the vacuum vessel. The toroidal field provides the primary mechanism of confinement of the plasma particles.
- The poloidal field - which produces a field around the plasma cross section. It pinches the plasma away from the walls and maintains the plasma's shape and stability. The poloidal field is induced both internally, by the current driven in the plasma (one of the plasma heating mechanisms), and externally, by coils that are positioned around the perimeter of the vessel.

The main plasma current is induced in the plasma by the action of a large transformer. A changing current in the primary winding or solenoid (a multi turn coil wound onto a large iron core in JET) induces a powerful current (up to 5 Million Amperes on JET) in the plasma - which acts as the transformer secondary circuit

One of the main requirements for fusion is to heat the plasma particles to very high temperatures or energies. The following methods are typically used to heat the plasma - all of them are employed on JET .

3. Principle methods of heating plasma:

3.1. Ohmic Heating and Current Drive

Currents up to 5 million amperes (5MA) are induced in the JET plasma - typically via the transformer or solenoid. As well as providing a natural pinching of the plasma column away from the walls, the current inherently heats the plasma - by energizing plasma electrons and ions in a particular toroidal direction. A few MW of heating power is provided in this way.

3.2. Neutral Beam Heating

Beams of high energy, neutral deuterium or tritium atoms are injected into the plasma, transferring their energy to the plasma via collisions with the plasma ions. The neutral beams are produced in two distinct phases. Firstly, a beam of energetic ions is produced

by applying an accelerating voltage of up to 140,000 Volts. However, a beam of charged ions will not be able to penetrate the confining magnetic field in the tokamak. Thus, the second stage ensures the accelerated beams are neutralized (i.e. the ions turned into neutral atoms) before injection into the plasma. In JET, up to 21MW of additional power is available from the NBI heating systems.

3.3. Radio-Frequency Heating

As the plasma ions and electrons are confined to rotate around the magnetic field lines in the tokamak, electromagnetic waves of a frequency matched to the ions or electrons are able to resonate - or damp its wave power into the plasma particles. As energy is transferred to the plasma at the precise location where the radio waves resonate with the ion/electron rotation, such wave heating schemes has the advantage of being localized at a particular location in the plasma.

In JET, eight antennae in the vacuum vessel propagate waves in the frequency range of 25-55 MHz into the core of the plasma. These waves are tuned to resonate with particular ions in the plasma - thus heating them up. This method can inject up to 20MW of heating power.

Waves can also be used to drive current in the plasma - by providing a "push" to electrons traveling in one particular direction. In JET, 10 MW of these so-called Lower Hybrid microwaves (at 3.7GHz) accelerate the plasma electrons to generate a plasma current of up to 3 MA.

3.4. Self Heating of Plasma

The Helium ions (or so-called alpha-particles) produced when Deuterium and Tritium fuse remain within the plasma's magnetic trap for a time - before they are pumped away through the diverter. The neutrons (being neutral) escape the magnetic field and their capture in a future fusion power plant will be the source of fusion power to produce electricity.

The fusion energy contained within the Helium ions heats the D and T fuel ions (by collisions) to keep the fusion reaction going. When this self heating mechanism is sufficient to maintain the required plasma temperature for fusion, the reaction becomes self-sustaining (i.e. no external plasma heating is required). This condition is referred to as Ignition.

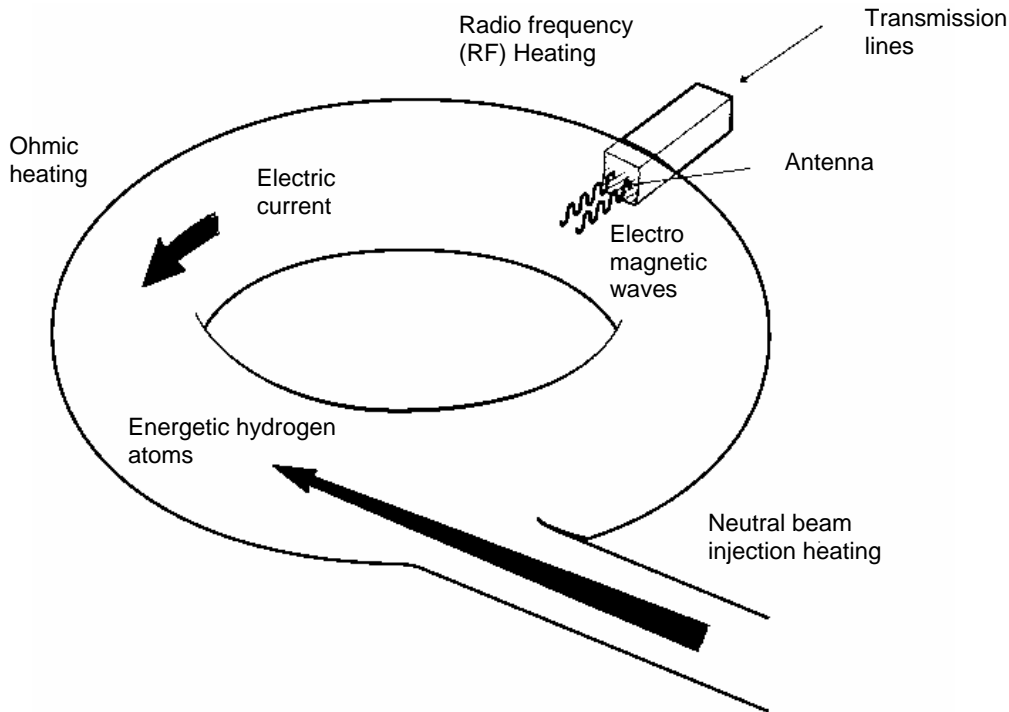

3.5. Measuring the plasma

Measuring the key plasma properties is one of the most challenging aspects of fusion research. Knowledge of the important plasma parameters (temperature, density, radiation losses) is very important in increasing the understanding of plasma behaviour and designing, with confidence, future devices. However, as the plasma is contained in a vacuum vessel and its properties are extreme (extremely low density and extremely high temperature), conventional methods of measurement are not appropriate. Thus, plasma diagnostics are normally very innovative and often measure a physical process from which information on a particular parameter can be deduced.

Measurement techniques can be categorized as active or passive. In active plasma diagnostics, the plasma is probed (via laser beams, microwaves, probes) to see how the plasma responds. For instance, in interferometers, the passage of a microwave beam through the plasma will be slow by the presence of the plasma (compared to the passage through vacuum). This measures the refractive index of the plasma from which the density of plasma ions/electrons can be interpreted. With all active diagnostics, it must be

ensured that the probing mechanism does not significantly affect the behaviour of the plasma.

With passive plasma diagnostics, radiation and particles leaving the plasma are measured - and this knowledge is used to deduce how the plasma behaves under certain conditions. For instance, during D-T operation on JET, neutron detectors measure the flux of neutrons emitted from the plasma. All wavelengths of radiated waves (visible, UV waves, X-rays etc) are also measured - often from many locations in the plasma. Then a detailed knowledge of the process which created the waves can enable a key plasma parameter to be deduced.

4. 1. The Hydrogen Bomb: The Basics

A fission bomb, called the primary, produces a flood of radiation including a large number of neutrons. This radiation impinges on the thermonuclear portion of the bomb, known as the secondary. The secondary consists largely of lithium deuteride. The neutrons react with the lithium in this chemical compound, producing tritium and helium.

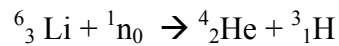

The production of tritium from lithium deuteride

This reaction produces the tritium on the spot, so there is no need to include tritium in the bomb itself. In the extreme heat which exists in the bomb, the tritium fuses with the deuterium in the lithium deuteride.

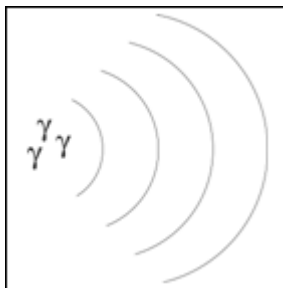

The question facing designers was "How do you build a bomb that will maintain the high temperatures required for thermonuclear reactions to occur?" The shock waves produced by the primary (A-bomb) would propagate too slowly to permit assembly of the

thermonuclear stage before the bomb blew itself apart. This problem was solved by Edward Teller and Stanislaw Ulam.

To do this, they introduced a high energy gamma ray absorbing material (styrofoam) to capture the energy of the radiation. As high energy gamma radiation from the primary is absorbed, radial compression forces are exerted along the entire cylinder at almost the same instant. This produces the compression of the lithium deuteride. Additional neutrons are also produced by various components and reflected towards the lithium deuteride. With the compressed lithium deuteride core now bombarded with neutrons, tritium is formed and the fusion process begins.

4.1.1. The Hydrogen Bomb: Schematic

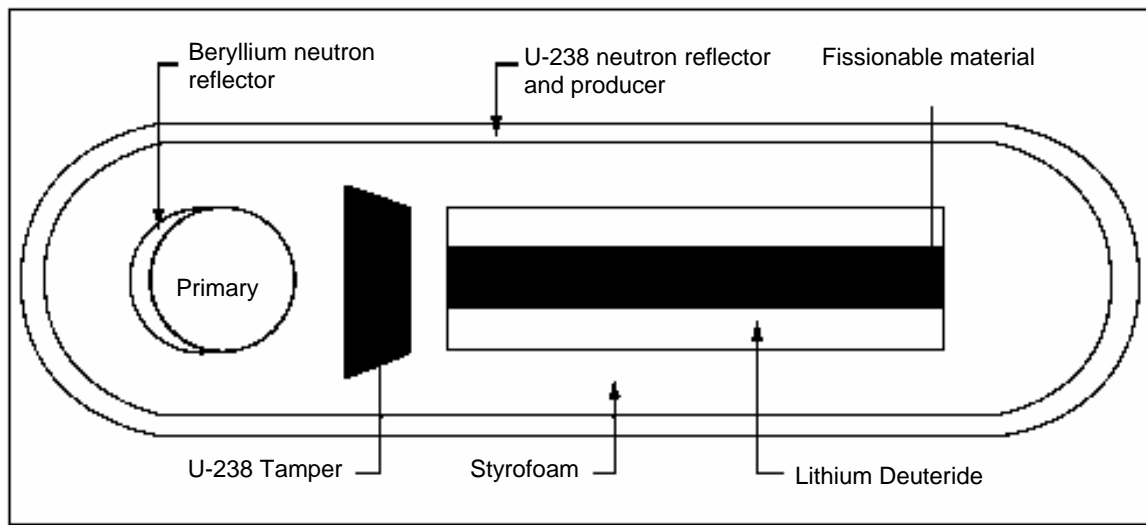

The yield of a hydrogen bomb is controlled by the amounts of lithium deuteride and of additional fissionable materials. Uranium 238 is usually the material used in various parts of the bomb's design to supply additional neutrons for the fusion process. This additional fissionable material also produces a very high level of radioactive fallout.

4.2. The Neutron Bomb

The neutron bomb is a small hydrogen bomb. The neutron bomb differs from standard nuclear weapons insofar as its primary lethal effects come from the radiation damage caused by the neutrons it emits. It is also known as an enhanced-radiation weapon (ERW).

The augmented radiation effects mean that blast and heat effects are reduced so that physical structures including houses and industrial installations, are less affected. Because neutron radiation effects drop off very rapidly with distance, there is a sharper distinction between areas of high lethality and areas with minimal radiation doses.

5. Advantages of fusion

Fusion offers significant potential advantages as a future source of energy - as just part of a varied world energy mix.

5.1. Abundant fuels

Deuterium is abundant as it can be extracted from all forms of water. If the entire world's electricity were to be provided by fusion power stations, present deuterium supplies from water would last for millions of years.

Tritium does not occur naturally and will be bred from Lithium within the machine. Therefore, once the reaction is established, even though it occurs between Deuterium and Tritium, the external fuels required are Deuterium and Lithium.

Lithium is the lightest metallic element and is plentiful in the earth's crust. If all the world's electricity were to be provided by fusion, known Lithium reserves would last for at least one thousand years.

The energy gained from a fusion reaction is enormous. To illustrate, 10 grams of Deuterium (which can be extracted from 500 litres of water) and 15g of Tritium (produced from 30g of Lithium) reacting in a fusion power plant would produce enough energy for the lifetime electricity needs of an average person in an industrialized country.

5.2. Inherent safety

The fusion process in a future power station will be inherently safe. As the amount of Deuterium and Tritium in the plasma at any one time is very small (just a few grams) and the conditions required for fusion to occur (e.g. plasma temperature and confinement) are difficult to attain, any deviation away from these conditions will result in a rapid cooling of the plasma and its termination. There are no circumstances in which the plasma fusion reaction can 'run away' or proceed into an uncontrollable or critical condition.

5.3. Environmental advantages

Like conventional nuclear (fission) power, fusion power stations will produce **no** 'greenhouse' gases - and will not contribute to global warming.

As fusion is a nuclear process the fusion power plant structure will become radioactive - by the action of the energetic fusion neutrons on material surfaces. However, this activation decays rapidly and the time span before it can be re-used and handled can be minimized (to around 50 years) by careful selection of low-activation materials. In addition, unlike fission, there is no radioactive 'waste' product from the fusion reaction itself. The fusion byproduct is Helium - an inert and harmless gas.

References

1. Essentials of Nuclear Chemistry, H. J. Arnikar, Fourth Edition, New Age International (P) Limited, Publishers, 1995.
2. Chemistry of Nuclear Power, J. K. Dawson and G. Long.
3. Nuclear Energy, Raymond I Murry.
4. <http://hyperphysics.phy-astr.gsu.edu/HBASE/nucene/fusion.htm/>
5. <http://fusedweb.pppl.gov>

Chapter – 7

BATTERIES - FUNDAMENTALS

M. Helen

1. Introduction

Batteries are all over the place -- in our cars, our PCs, laptops, portable MP3 players and cell phones. A battery is essentially a can full of chemicals that produce electrons. Chemical reactions that produce electrons are called **electrochemical reactions**. The basic concept at work, the actual chemistry going on inside a battery and what the future holds for batteries are the scope of this chapter.

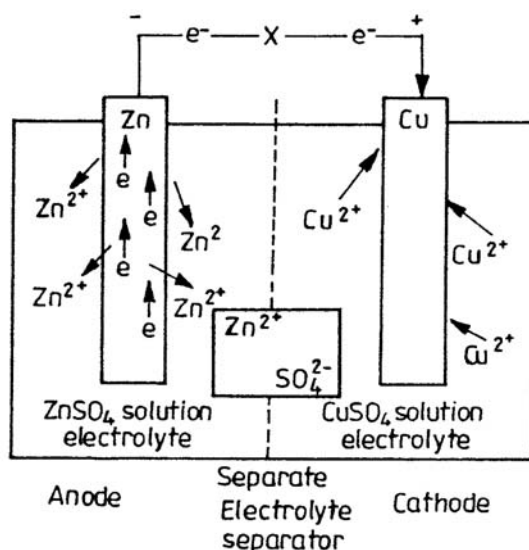

Fig 1. Representation of a battery (Daniel cell) showing the key features of battery operation

If you look at any battery, you will notice that it has two terminals. One terminal is marked (+), or positive is cathode, while the other is marked (-), or negative is the anode. The *anode* is the negative electrode of a cell associated with oxidative chemical reactions that release electrons into the external circuit. The *cathode* is the positive electrode of a cell associated with reductive chemical reactions that gain electrons from the external circuit. We also have *active mass*, material that generates electrical current by means of a

chemical reaction within the battery. An *electrolyte* is a material that provides pure ionic conductivity between the positive and negative electrodes of a cell and a *separator* is a physical barrier between the positive and negative electrodes incorporated into most cell designs to prevent electrical shorting. The separator can be a gelled electrolyte or a microporous plastic film or other porous inert material filled with electrolyte. Separators must be permeable to the ions and inert in the battery environment.

2. Battery Operation

The negative electrode is a good reducing agent (electron donor) such as lithium, zinc, or lead. The positive electrode is an electron acceptor such as lithium cobalt oxide, manganese dioxide, or lead oxide. The electrolyte is a pure ionic conductor that physically separates the anode from the cathode. In practice, a porous electrically insulating material containing the electrolyte is often placed between the anode and cathode to prevent the anode from directly contacting the cathode. Should the anode and cathode physically touch, the battery will be shorted and its full energy released as heat inside the battery. Electrical conduction in electrolytic solutions follows Ohm's law: $E = IR$

Two dissimilar metals placed in an acid bath produce electrical potential across the poles. The cell produces voltage by a chemical reaction between the plates and the electrolyte. The positive plate is made of reddish-brown material such as lead dioxide (PbO_2) while the negative plate is made of grayish material called sponge lead (Pb). The acid bath is a mixture of sulfuric acid and water giving the cell electrolyte. Together a cell element is formed as shown in Fig.2.

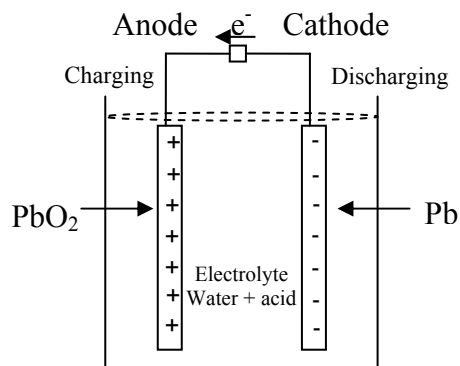

Fig 2. Representation of a lead acid battery

3. Cycling

The battery stores electricity in the form of chemical energy. Through a chemical reaction process, the battery creates and releases electricity as needed by the electrical system or devices. Since the battery loses its chemical energy in this process, the battery must be recharged by the alternator. By reversing electrical current flow through the battery the chemical process is reversed, thus charging the battery. The cycle of discharging and charging is repeated continuously and is called "battery cycling".

4. History of Batteries

The first battery was created by Alessandro Volta in 1800. To create his battery, he made a stack by alternating layers of zinc, blotting paper soaked in salt water, and silver. This arrangement was known as a voltaic pile. The top and bottom layers of the pile must be different metals, as shown in Fig.3. If one attaches a wire to the top and bottom of the pile, one can measure a voltage and a current from the pile.

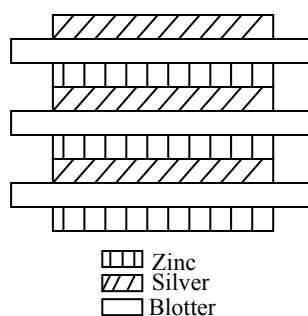

Fig.3. Zinc-silver voltaic pile

In the 1800s, before the invention of the electrical generator, the Daniel cell (which is also known by three other names -- the "Crowfoot cell" because of the typical shape of the zinc electrode, the "gravity cell" because gravity keeps the two sulfates separated, and a "wet cell," as opposed to the modern "dry cell," because it uses liquids for the electrolytes), was common for operating telegraphs and doorbells. The Daniel cell is a wet cell consisting of copper and zinc plates and copper and zinc sulphates. The Plante lead acid battery was introduced in 1859 and Leclanche introduced in 1869 the forerunner of today's dry cell. The first true dry cell was developed in 1881 by Gassner and commercial production of the cell was then started. The other important dates in the history of the battery are: 1900- the Edison nickel storage battery, 1943-the Adams copper chlorine battery, 1945-the mercury cell, and 1955- the alkaline manganese dioxide dry cell. Developments continue to meet

the requirements of current technology. Lithium batteries are commonly used in many devices and sodium sulphur battery has been developed for automobiles.

5. Classification of batteries

Batteries can either be a primary cell, such as a flashlight battery once used, throw it away, or a secondary cell, such as a car battery (when the charge is gone, it can be recharged).

Primary cell: Because the chemical reaction totally destroys one of the metals after a period of time, primary cells cannot be recharged. Small batteries such as flashlight and radio batteries are primary cells.

Secondary cell: The metal plates and acid mixture change as the battery delivers current. As the battery drains the metal plates become similar and the acid strength weakens. This process is called discharging. By applying current to the battery in the reverse direction, the battery materials can be restored, thus recharging the battery. This process is called charging. Automotive lead-acid batteries are secondary cells and can be recharged.

These batteries are also classified as wet or dry charged batteries. Batteries can be produced as Wet-Charged, such as current automotive batteries are today, or they can be Dry-Charged, such as a motorcycle battery where an electrolyte solution is added when put into service.

- **WET-CHARGED:** The lead-acid battery is filled with electrolyte and charged when it is built. Periodic charging is required. Most batteries sold today are wet charged.
- **DRY-CHARGED:** The battery is built, charged, washed and dried, sealed, and shipped without electrolyte. It can be stored for up to 18 months. When put into use, electrolyte and charging are required. Batteries of this type have a long shelf life. Motorcycle batteries are typically dry charged batteries.

6. Primary batteries

6.1. Leclanché Cells (zinc carbon or dry cell)

The basic design of the Leclanché cell has been around since the 1860s, and until World War II, was the only one in wide use. It is still the most commonly used of all primary battery designs because of its low cost, availability, and applicability in various situations. However, because the Leclanché cell must be discharged intermittently for

best capacity, much of battery research in the last three decades has focused on zinc-chloride cell systems, which have been found to perform better than the Leclanché under heavier drain.

Anode: Zinc

Cathode: Manganese Dioxide (MnO_2)

Electrolyte: Ammonium chloride or zinc chloride dissolved in water

Applications: Flashlights, toys, moderate drain use

In an ordinary Leclanché cell the electrolyte consists (in percent of atomic weight) of 26% NH_4Cl (ammonium chloride), 8.8% ZnCl_2 (zinc chloride), and 65.2% water. The overall cell reaction can be expressed:



The electrolyte in a typical zinc chloride cell consists of 15-40% ZnCl_2 and 60-85% water, sometimes with a small amount of NH_4Cl for optimal performance. The overall cell reaction of the zinc chloride as the electrolyte can be expressed:

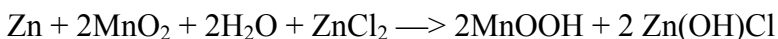

MnO_2 , is only slightly conductive, so graphite is added to improve conductivity. The cell voltage increases by using synthetically produced manganese dioxide instead of that found naturally (called pyrolusite). This does drive the cost up a bit, but it is still inexpensive and environmentally friendly, making it a popular cathode.

These cells are the cheapest ones in wide use, but they also have the lowest energy density and perform poorly under high-current applications. Still, the zinc carbon design is reliable and more than adequate for many everyday applications.

6.2. Alkaline Cells

This cell design gets its name from the use of alkaline aqueous solutions as electrolytes. Alkaline battery chemistry was first introduced in the early 1960s. The alkaline cell has grown in popularity, becoming the zinc-carbon cell's greatest competitor. Alkaline cells have many acknowledged advantages over zinc-carbon, including a higher energy density, longer shelf life, superior leakage resistance, better performance in both continuous and intermittent duty cycles, and lower internal resistance, which allows it to operate at high discharge rates over a wider temperature range.

Anode: Zinc powder

Cathode: Manganese dioxide (MnO_2) powder

Electrolyte: Potassium hydroxide (KOH)

Applications: Radios, toys, photo-flash applications, watches, high-drain applications

Zinc in powdered form increases the surface area of the anode, allowing more particle-particle interaction. This lowers the internal resistance and increases the power density. The cathode, MnO_2 , is synthetically produced because of its superiority to naturally occurring MnO_2 . This increases the energy density. Just as in the zinc carbon cell, graphite is added to the cathode to increase conductivity. The electrolyte, KOH, allows high ionic conductivity. Zinc oxide is often added to slow down corrosion of the zinc anode. A cellulose derivative is thrown in as a gelling agent. These materials make the alkaline cell more expensive than the zinc-carbon, but its improved performance makes it more cost effective, especially in high drain situations where the alkaline cell's energy density is higher.

The half-reactions are:

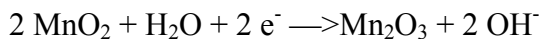
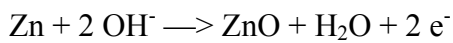

The overall reaction is:



There are other cell designs that fit into the alkaline cell category, including the mercury oxide, silver oxide, and zinc air cells. Mercury and silver give even higher energy densities, but cost a lot more and are being phased out through government regulations because of their high heavy metal toxicity. The mercury oxide, silver oxide, and zinc air (which are being developed for electronic vehicles) are considered separately.

6.3. Mercury Oxide Cells

This is an obsolete technology. Most if not all of the manufacture of these cells has been stopped by government regulators. Mercury batteries come in two main varieties: zinc/mercuric oxide and cadmium/mercuric oxide. The zinc/mercuric oxide system has high volumetric specific energy (400 Wh/L), long storage life, and stable voltage. The cadmium/mercuric oxide system has good high temperature and good low temperature (-55 °C to +80°C, some designs to +180°C) operation and has very low gas evolution.

Anode: Zinc (or cadmium)

Cathode: Mercuric Oxide (HgO)

Electrolyte: Potassium hydroxide

Applications: Small electronic equipment, hearing aids, photography, alarm systems, emergency beacons, detonators, radio microphones

Basic cell reaction:

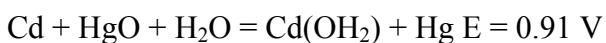
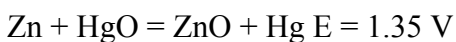

The electrolytes used in mercury cells are sodium and/or potassium hydroxide solutions, making these alkaline cells. These cells are not rechargeable.

6.4. Zinc/Air Cells

The zinc air cell fits into the alkaline cell category because of its electrolyte. It also acts as a partial fuel cell because it uses the O_2 from air as the cathode. This cell is an interesting technology, even aside from the question "how do you use air for an electrode?" Actually, oxygen is let in to the cathode through a hole in the battery and is reduced on a carbon surface.

Anode: Amalgamated zinc powder and electrolyte

Cathode: Oxygen (O_2)

Electrolyte: Potassium hydroxide (KOH)

Applications: Hearing aids, pagers, electric vehicles

A number of battery chemistries are involved in a metal oxide and zinc. The metal oxide reduces, the zinc becomes oxidized, and electric current results. A familiar example is the old mercury oxide/zinc batteries used for hearing aids. If you leave out the metal oxide you could double the capacity per unit volume (roughly), but where would you get the oxygen?

The half-reactions are:

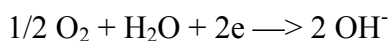
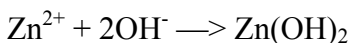

The overall reaction is:

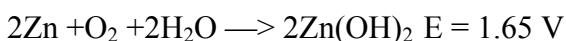

The electrolyte is an alkali hydroxide in 20-40% weight solution with water. One disadvantage is that since these hydroxides are hygroscopic, they will pick up or lose water from the air depending on the humidity. Both too little and too much humidity reduces the life of the cell. Selective membranes can help. Oxygen from air dissolves in the electrolyte through a porous, hydrophobic electrode—a carbon-polymer or metal-polymer composite.

The energy density of these batteries can be quite high, between 220–300 Wh/kg (compared to 99–123 Wh/kg with an HgO cathode), although the power density remains low. However, the use of potassium or sodium hydroxides as the electrolyte is a problem, since these can react with carbon dioxide in the air to form alkali carbonates. For this reason large zinc air batteries usually contain a higher volume of CO₂ absorbing material (calcium oxide flake) than battery components. This can cancel out the huge increase in energy density gained by using the air electrode.

This cell has the additional benefits of being environmentally friendly at a relatively low cost. These batteries can last indefinitely before they are activated by exposing them to air, after which they have a short shelf life. For this reason (as well as the high energy density) most zinc-air batteries are used in hearing aids.

6.5. Aluminum / Air Cells

Although, to our way of thinking, the metal/air batteries are strictly primary, cells have been designed to have the metal replaceable. These are called *mechanically rechargeable* batteries. Aluminum/air is an example of such a cell. Aluminum is attractive for such cells because it is highly reactive, the aluminum oxide protective layer is dissolved by hydroxide electrolytes, and it has a high voltage.

Half cell reactions are:

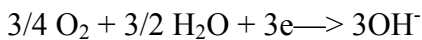
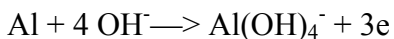

The overall reaction is

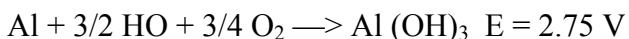

As mentioned above, alkali (chiefly potassium hydroxide) electrolytes are used, but so also are neutral salt solutions. The alkali cell has some problem with the air electrode, because the hydroxide ion makes a gel in the porous electrode, polarizing it. The typical

aluminum hydroxide gel is a problem on either electrode because it sucks up a lot of water. Using a concentrated caustic solution prevents this, but is very reactive with the aluminum electrode, producing hydrogen gas. Another way to prevent the gel formation is to seed the electrolyte with aluminum trihydroxide crystals. These act to convert the aluminum hydroxide to aluminum trihydroxide crystals and they grow. To prevent hydrogen gas evolution tin and zinc have been used as corrosion inhibitors. A number of additives are used to control the reactions. A disadvantage of the alkaline electrolyte is that it reacts with atmospheric carbon dioxide.

Aluminum / air cells have also been made for marine applications. These are "rechargeable" by replacing the sea water electrolyte until the aluminum is exhausted, then replacing the aluminum. Some cells that are open to sea water have also been researched. Since salt water solutions tend to passivate the aluminum, pumping the electrolyte back and forth along the cell surface has been successful. For those cells that do not need to use ocean water, an electrolyte of KCl and KF solutions is used.

Air electrodes of Teflon-bonded carbon are used without a catalyst.

6.6. Lithium Cells

Chemistry of lithium battery comprises a number of cell designs that use lithium as the anode. Lithium is gaining a lot of popularity as an anode for a number of reasons. Note that lithium, the lightest of the metals, also has the highest standard potential of all the metals, at over 3 V. Some of the lithium cell designs have a voltage of nearly 4 V. This means that lithium has the highest energy density. Many different lithium cells exist because of its stability and low reactivity with a number of cathodes and non-aqueous electrolytes. The most common electrolytes are organic liquids with the notable exceptions of SOCl_2 (thionyl chloride) and SO_2Cl_2 (sulfuryl chloride). Solutes are added to the electrolytes to increase conductivity.

Lithium cells have only recently become commercially viable because lithium reacts violently with water, as well as nitrogen in air. This requires sealed cells. High-rate lithium cells can build up pressure if they short circuit and cause the temperature and pressure to rise. Thus, the cell design needs to include weak points, or safety vents, which rupture at a certain pressure to prevent explosion.

Lithium cells can be grouped into three general categories: liquid cathode, solid cathode, and solid electrolyte. Let's look at some specific lithium cell designs within the context of these three categories

6.6.1. Liquid cathode lithium cells

These cells tend to offer higher discharge rates because the reactions occur at the cathode surface. In a solid cathode, the reactions take longer because the lithium ions must enter into the cathode for discharge to occur. The direct contact between the liquid cathode and the lithium forms a film over the lithium, called the solid electrolyte interface (SEI). This prevents further chemical reaction when not in use, thus preserving the cell's shelf life. One drawback, though, is that if the film is too thick, it causes an initial voltage delay. Usually, water contamination is the reason for the thicker film, so quality control is important.

- LiSO_2 Lithium–Sulfur Dioxide

This cell performs well in high current applications as well as in low temperatures. It has an open circuit voltage of almost 3 V and a typical energy density of 240–280 Wh/kg. It uses a cathode of porous carbon with sulfur dioxide taking part in the reaction at the cathode. The electrolyte consists of an acetonitrile solvent and a lithium bromide solute. Polypropylene acts as a separator. Lithium and sulfur dioxide combine to form lithium dithionite:

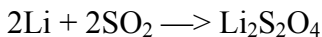

These cells are mainly used in military applications for communication because of high cost and safety concerns in high-discharge situations, i.e., pressure buildup and overheating.

- LiSOCl_2 Lithium Thionyl Chloride

This cell consists of a high-surface area carbon cathode, a non-woven glass separator, and thionyl chloride, which doubles as the electrolyte solvent and the active cathode material. Lithium aluminum chloride (LiAlCl_4) acts as the electrolyte salt.

The materials react as follows:

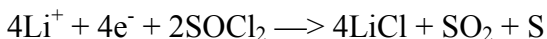

overall reaction:

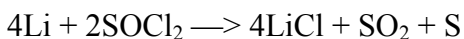

During discharge the anode gives off lithium ions. On the carbon surface, the thionyl chloride reduces to chloride ions, sulfur dioxide, and sulfur. The lithium and chloride ions then form lithium chloride. Once the lithium chloride has deposited at a site on the carbon surface, that site is rendered inactive. The sulfur and sulfur dioxide dissolve in the electrolyte, but at higher-rate discharges SO_2 will increase the cell pressure.

This system has a very high energy density (about 500 Wh/kg) and an operating voltage of 3.3–3.5 V. The cell is generally a low-pressure system

In high-rate discharge, the voltage delay is more pronounced and the pressure increases as mentioned before. Low-rate cells are used commercially for small electronics and memory backup. High-rate cells are used mainly for military applications.

6.6.2. Solid cathode lithium cells

These cells cannot be used in high-drain applications and do not perform as well as the liquid cathode cells in low temperatures. However, they do not have the same voltage delay and the cells do not require pressurization. They are used generally for memory backup, watches and portable electronic devices.

- LiMnO_2

These accounts for about 80% of all primary lithium cells, one reason being their low cost. The cathode used is a heat-treated MnO_2 and the electrolyte is a mixture of propylene carbonate and 1,2-dimethoxyethane. The half reactions are

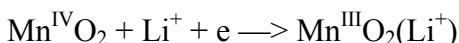
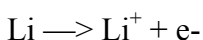

Overall reaction:

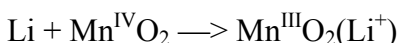

At lower temperatures and in high-rate discharge, the LiSO_2 cell performs better than the LiMnO_2 cell. At low-rate discharge and higher temperatures, the two cells perform equally well, but LiMnO_2 cell has the advantage because it does not require pressurization.

- $\text{Li}(\text{CF})_n$ Lithium polycarbon monofluoride

The cathode in this cell is carbon monofluoride, a compound formed through high-temperature intercalation. This is the process where foreign atoms (in this case fluorine

gas) are incorporated into some crystal lattice (graphite powder), with the atoms of the crystal lattice retaining their positions relative to one another.

A typical electrolyte is lithium tetrafluorobate (LiBF_4) salt in a solution of propylene carbonate (PC) and dimethoxyethane (DME)

These cells also have a high voltage (about 3.0 V open voltage) and a high energy density (around 250 Wh/kg). All this and a 7-year shelf life make them suitable for low- to moderate-drain use, e.g., watches, calculators, and memory applications.

6.6.3. Solid electrolyte lithium cells

All commercially manufactured cells that use a solid electrolyte have a lithium anode. They perform best in low-current applications and have a very long service life. For this reason, they are used in pacemakers

- LiI_2 —Lithium iodine cells use solid LiI as their electrolyte and also produce LiI as the cell discharges. The cathode is poly-2-vinylpyridine (P2VP) with the following reactions:

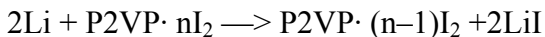
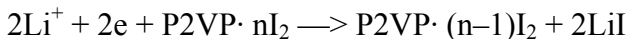
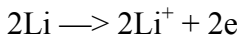

LiI is formed *in situ* by direct reaction of the electrodes.

6.7. Lithium-Iron Cells

The Lithium-Iron chemistry deserves a separate section because it is one of a handful of lithium metal systems that have a 1.5 volt output (others are lithium/lead bismuthate, lithium/bismuth trioxide, lithium/copper oxide, and lithium/copper sulfide). Recently consumer cells that use the Li/Fe have reached the market, including the Energizer. These have the advantage of having the same voltage as alkaline batteries with more energy storage capacity, so they are called "voltage compatible" lithium cells. They are not rechargeable. They have about 2.5 times the capacity of an alkaline battery of the same size, but only under high current discharge conditions (digital cameras, flashlights, motor driven toys, etc.). For small currents they do not have any advantage. Another advantage is the low self-discharge rate—10 year storage is quoted by the manufacturer. The discharge reactions are:



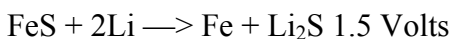

Both Iron sulfide and Iron disulfide are used, the FeS_2 is used in the Energizer. Electrolytes are organic materials such as propylene carbonate, dioxolane and dimethoxyethane.

6.8. Magnesium-Copper Chloride Reserve Cells

The magnesium-cuprous chloride system is a member of the reserve cell family. It can't be used as a primary battery because of its high self-discharge rate, but it has a high discharge rate and power density, so it can be made "dry charged" and sit forever ready, just add water. The added advantage of being light-weight has made these practical for portable emergency batteries. It works by depositing copper metal out onto the magnesium anode, just like the old copper-coated nail experiment. Variations of this battery use silver chloride, lead chloride, copper iodide, or copper thiocyanate to react with the magnesium. The torpedo batteries force seawater through the battery to get up to 460 kW of power to drive the propeller.

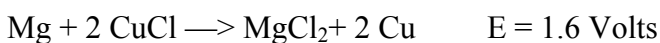

7. Secondary Batteries

7.1. Lead-acid Cells

Anode: Sponge metallic lead

Cathode: Lead dioxide (PbO_2)

Electrolyte: Dilute mixture of aqueous sulfuric acid

Applications: Motive power in cars, trucks, forklifts, construction equipment, recreational water craft, standby/backup systems

Used mainly for engine batteries, these cells represent over half of all battery sales. Some advantages are their low cost, long life cycle, and ability to withstand mistreatment. They also perform well in high and low temperatures and in high-drain applications. The chemistry of lead acid battery in terms of half-cell reactions are:

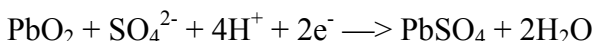
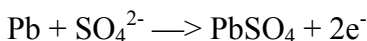

There are a few problems with this design. If the cell voltages exceed 2.39 V, the water breaks down into hydrogen and oxygen (this so-called gassing voltage is temperature dependent). This requires replacing the cell's water. Also, as the hydrogen and oxygen

vent from the cell, too high a concentration of this mixture will cause an explosion. Another problem arising from this system is that fumes from the acid or hydroxide solution may have a corrosive effect on the area surrounding the battery.

These problems are mostly solved by sealed cells, made commercially available in the 1970s. In the case of lead acid cells, the term "valve-regulated cells" is more accurate, because they cannot be sealed completely. If they were, the hydrogen gas would cause the pressure to build up beyond safe limits. Catalytic gas recombination does a great deal to alleviate this problem. They convert the hydrogen and oxygen back into water, achieving about 85% efficiency at best. Although this does not entirely eliminate the hydrogen and oxygen gas, the water lost becomes so insignificant that no refill is needed for the life of the battery. For this reason, these cells are often referred to as maintenance-free batteries. Also, this cell design prevents corrosive fumes from escaping.

These cells have a low cycle life, a quick self discharge, and low energy densities (normally between 30 and 40 Wh/kg). However, with a nominal voltage of 2 V and power densities of up to 600 W/kg, the lead-acid cell is an adequate, if not perfect, design for car batteries.

7.2. Nickel/Cadmium Cells

Anode: Cadmium

Cathode: Nickel oxyhydroxide Ni(OH)_2

Electrolyte: Aqueous potassium hydroxide (KOH)

Applications: Calculators, digital cameras, pagers, lap tops, tape recorders, flashlights, medical devices (e.g., defibrillators), electric vehicles, space applications

The cathode is nickel-plated, woven mesh, and the anode is a cadmium-plated net. Since the cadmium is just a coating, this cell's negative environmental impact is often exaggerated. (Incidentally, cadmium is also used in TV tubes, some semiconductors, and as an orange-yellow dye for plastics.) The electrolyte, KOH, acts only as an ion conductor and does not contribute significantly to the cell's reaction. That's why not much electrolyte is needed, so this keeps the weight down. (NaOH is sometimes used as an electrolyte, which does not conduct as well, but also does not tend to leak out of the seal as much). Here are the cell reactions:

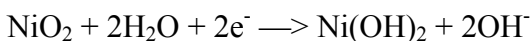
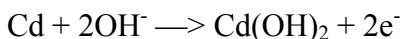

Overall reaction:

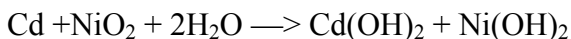

Advantages include good performance in high-discharge and low-temperature applications. They also have long shelf and use life. Disadvantages are that they cost more than the lead-acid battery and have lower power densities. Possibly the most well-known limitation is a memory effect, where the cell retains the characteristics of the previous cycle.

This term refers to a temporary loss of cell capacity, which occurs when a cell is recharged without being fully discharged. This can cause cadmium hydroxide to passivate the electrode, or the battery to wear out. In the former case, a few cycles of discharging and charging the cell will help correct the problem, but may shorten the life time of the battery. The true memory effect comes from the experience with a certain style of Ni-Cd in space use, which was cycled within a few percent of discharge each time.

An important thing to know about "conditioning" a Ni-Cd battery is that the deep discharge.

7.3. Nickel/Metal Hydride (NiMH) Cells

Anode: Rare-earth or nickel alloys with many metals

Cathode: Nickel oxyhydroxide

Electrolyte: Potassium hydroxide

Applications: Cellular phones, camcorders, emergency backup lighting, power tools, laptops, portable, electric vehicles

This sealed cell is a hybrid of the NiCd and NiH₂ cells. Previously, this battery was not available for commercial use because, although hydrogen has wonderful anodic qualities, it requires cell pressurization. Fortunately, in the late 1960s scientists discovered that some metal alloys (hydrides such as LiNi₅ or ZrNi₂) could store hydrogen atoms, which then could participate in reversible chemical reactions. In modern NiMH batteries, the anode consists of many metals alloys, including V, Ti, Zr, Ni, Cr, Co, and Fe.

Except for the anode, the NiMH cell very closely resembles the NiCd cell in construction. Even the voltage is virtually identical, at 1.2 volts, making the cells interchangeable in many applications. The cell reactions are:

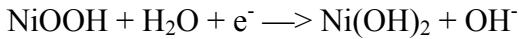
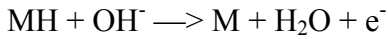

Over all reaction:



The anodes used in these cells are complex alloys containing many metals, such as an alloy of V, Ti, Zr, Ni, Cr, Co and Fe. The underlying chemistry of these alloys and reasons for superior performance are not clearly understood, and the compositions are determined by empirical testing methods.

A very interesting fact about these alloys is that some metals absorb heat when absorbing hydrogen, and some give off heat when absorbing hydrogen. Both of these are bad for a battery, since one would like the hydrogen to move easily in and out without any energy transfer. The successful alloys are all mixtures of exothermic and endothermic metals to achieve this. The electrolyte of commercial NiMH batteries is typically 6 M KOH

The NiMH cell does cost more and has half the service life of the NiCd cell, but it also has 30% more capacity, increased power density (theoretically 50% more, practically 25% more). The memory effect, which was at one time thought to be absent from NiMH cells, is present if the cells are treated just right. To avoid the memory effect, fully discharge once every 30 or so cycles. There is no clear winner between the two. The better battery depends on what characteristics are crucial for a specific application.

7.4. Lithium Ion Cells

Anode: Carbon compound, graphite

Cathode: Lithium oxide

Electrolyte:

Applications: Laptops, cellular phones, electric vehicles

Lithium batteries that use lithium metal have safety disadvantages when used as secondary (rechargeable) energy sources. For this reason a series of cell chemistries have been developed using lithium compounds instead of lithium metal. These are called generically *Lithium ion Batteries*.

Cathodes consist of a layered crystal (graphite) into which the lithium is intercalated. Experimental cells have also used lithiated metal oxide such as LiCoO_2 , $\text{NiNi}_{0.3}\text{Co}_{0.7}\text{O}_2$, LiNiO_2 , LiV_2O_5 , $\text{LiV}_6\text{O}_{13}$, LiMn_4O_9 , LiMn_2O_4 , $\text{LiNiO}_{0.2}\text{CoO}_2$.

Electrolytes are usually LiPF_6 , although this has a problem with aluminum corrosion, and so alternatives are being sought. One such is LiBF_4 . The electrolyte in current production batteries is liquid, and uses an organic solvent.

Membranes are necessary to separate the electrons from the ions. Currently the batteries in wide use have microporous polyethylene membranes.

Intercalation (rhymes with relation—not inter-cal, but in-tercal-ation) is a long-studied process which has finally found a practical use. It has long been known that small ions (such as lithium, sodium, and the other alkali metals) can fit in the interstitial spaces in a graphite crystal. Not only that, but these metallic atoms can go farther and force the graphitic planes apart to fit two, three, or more layers of metallic atoms between the carbon sheets. You can imagine what a great way this is to store lithium in a battery—the graphite is conductive, dilutes the lithium for safety, is reasonably cheap, and does not allow dendrites or other unwanted crystal structures to form.

7.5. Manganese-Titanium (Lithium) Cells

Anode: Lithium-Titanium Oxide

Cathode: Lithium intercalated Manganese Dioxide

Electrolyte:

Applications: Watches, other ultra-low discharge applications

This technology might be called Manganese-Titanium, but it is just another lithium coin cell. It has "compatible" voltage – 1.5 V to 1.2 Volts, like the Lithium-Iron cell, which makes it convenient for applications that formerly used primary coin cells. It is unusual for a lithium based cell because it can withstand a continuous overcharge at 1.6 to 2.6 volts without damage. Although rated for 500 full discharge cycles, it only has a 10% a year self-discharge rate, and so is used in solar charged watches with expected life of 15+ years with shallow discharging. The amp-hour capacity and available current output of these cells is extremely meager. The range of capacities from Panasonic is 0.9 to 14 mA·H. The maximum continuous drain current is 0.1 to 0.5 mA.

7.6. Rechargeable Alkaline Manganese Cells

Anode: Zinc

Cathode: Manganese dioxide

Electrolyte: Potassium Hydroxide Solution

Applications: Consumer devices

This is the familiar alkaline battery, specially designed to be rechargeable, and with a hot new acronym—RAM. In the charging process, direct-current electrical power is used to reform the active chemicals of the battery system to their high-energy charge state. In the case of the RAM battery, this involves oxidation of manganese oxyhydroxide (MnOOH) in the discharged positive electrode to manganese dioxide (MnO_2), and of zinc oxide (ZnO) in the negative electrode to metallic zinc.

Care must be taken not to overcharge to prevent electrolysis of the KOH solution electrolyte, or to charge at voltages higher than 1.65 V (depending on temperature) to avoid the formation of higher oxides of manganese.

7.7. Redox (Liquid Electrode) Cells

These consist of a semi-permeable membrane having different liquids on either side. The membrane permits ion flow but prevents mixing of the liquids. Electrical contact is made through inert conductors in the liquids. As the ions flow across the membrane an electric current is induced in the conductors. These cells and batteries have two ways of recharging. The first is the traditional way of running current backwards. The other is replacing the liquids, which can be recharged in another cell. A small cell can also be used to charge a great quantity of liquid, which is stored outside the cells. This is an interesting way to store energy for alternative energy sources that are unreliable, such as solar, wind, and tide. These batteries have low volumetric efficiency, but are reliable and very long lived.

Electrochemical systems that can be used are FeCl_3 (cathode) and TiCl_3 or CrCl_2 (anode).

Vanadium redox cells: A particularly interesting cell uses vanadium oxides of different oxidation states as the anode and cathode. These solutions will not be spoiled if the membrane leaks, since the mixture can be charged as either reducing or oxidizing components.

8. Selection criteria for Battery Systems

A set of criteria that illustrate the characteristics of the materials and reactions for a commercial battery system are:

1. Mechanical and Chemical Stability: The materials must maintain their mechanical properties and their chemical structure and composition over the course of time and temperature as much as possible. Mechanical and chemical stability limitations arise from reaction with the electrolyte, irreversible phase changes and corrosion, isolation of active materials, and poor conductivity of materials in the discharged state, etc.

2. Energy Storage Capability: The reactants must have sufficient energy content to provide a useful voltage and current level, measured in Wh/L or Wh/kg. In addition, the reactants must be capable of delivering useful rates of electricity, measured in terms of W/L or W/kg. This implies that the kinetics of the cell reaction are fast and without significant kinetics hindrances. The carbon-zinc and Ni-Cd systems set the lower limit of storage and release capability for primary and rechargeable batteries, respectively.

3. Temperature Range of Operation: For military applications, the operational temperature range is from -50 to 85 °C. Essentially the same temperature range applies to automotive applications. For a general purpose consumer battery, the operating temperature range is 0-40 °C, and the storage temperatures range from -20 to 85 °C. These temperatures are encountered when using automobiles and hand-held devices in the winter in northern areas and in the hot summer sun in southern areas.

4. Self-Discharge: Self-discharge is the loss of performance when a battery is not in use. An acceptable rate of loss of energy in a battery depends somewhat on the application and the chemistry of the system. People expect a battery to perform its intended task on demand. Li-MnO₂ primary cells will deliver 90% of their energy even after 8 years on the shelf; that is, their self-discharge is low. Some military batteries have a 20-year storage life and still deliver their rated capacity.

5. Cost: The cost of the battery is determined by the materials used in its fabrication and the manufacturing process. The manufacturer must be able to make a profit on the sale to the customer. The selling price must be in keeping with its perceived value (tradeoff of the ability of the user to pay the price and the performance of the battery).

6. Safety: All consumer and commercial batteries must be safe in the normal operating environment and not present any hazard under mild abuse conditions. The cell or battery should not leak, vent hazardous materials, or explode.

References

1. R. Narayan and B. Viswanathan. 'Chemical and electrochemical energy systems', University Press (India) Ltd, 1998.
2. www.duracell.com/OEM
3. data.energizer.com
4. www.powerstream.com
5. M. Winter, R. J. Brodd, *Chem. Rev.* **104** (2004) 4245-4269.

Chapter - 8

SOLID STATE BATTERIES

L. Hima Kumar

1. Introduction

A force is something that pushes against something else such as gravity. Should it succeed, work gets done. If a one pound weight is lifted one foot, then one foot-pound of work has been done on the weight itself. Both force and distance are needed before work gets done. Energy is just the capacity to do work or the ability to employ a force that moves something through a distance or performs some exact electrical, thermal, chemical, or whatever equivalent to mechanical work. Power is the time rate of doing work. Thus, energy is "how much" and power is "how fast". An energy source is a substance or a system that can be capable of delivering net kilowatt hours of energy.

An energy carrier is some means of moving energy from one location to another. Batteries, flywheels, utility pumped storage and terrestrial hydrogen are examples. They are carriers or "energy transfer systems" because you first have to "fill" them with energy before you can "empty" them. Without fail, all energy carriers consume significantly more existing old energy than they can return as new.

Batteries are devices which convert chemical energy into electrical energy. Thermodynamically, an electrochemical e.m.f. system (a so-called battery) is generated if an electrolyte is sandwiched between two electrode materials with different chemical potentials. Further, if a constant supply of ions can be maintained and transported through the electrolyte, it will deliver current when connected across a load resistance. Two different kinds of batteries are used, primary and secondary; they comprise liquid or solid electrodes and electrolytes. Primary batteries are batteries designed to be used for one discharge cycle (non-rechargeable) and then discarded. Secondary batteries are designed to be recharged and re-used many times and are better known as rechargeable batteries. Batteries can also be classified by the type of electrolyte which they contain. The electrolyte can either be liquid (wet cell batteries) or paste-like/gel-like (dry cell batteries).

All batteries operate on the principles of electrochemistry. An electrochemical reaction is one in which electrons are transferred from one chemical species to another as the chemical reaction is taking place. In a battery these reactions take place at the electrodes of the battery. At the battery electrode known as the anode a reaction takes place known as oxidation. During oxidation a chemical species loses electrons. The other electrode in a battery is known as the cathode. Reaction known as reduction occurs at the cathode where by electrons are combined with ions to form stable electrically balanced chemical species. Batteries take advantage of these reactions by making the electrons formed by oxidation on the anode flow through a wire to the cathode where they are used in the reduction reaction. A load can be attached along this circuit in order to take advantage of the current of electrons in order to power a device. Electrons move through the wire from the anode to cathode because the conductive nature of the wire connecting the two makes that path the easiest way for the electrons to get there.

The rechargeable, or secondary, batteries can be distinguished on the following parameters. Voltage, current (maximum, steady state and peak), energy density (watt-hours per kilogram and per liter), power density (watts per kilogram and per liter), and service life (cycles to failure) and cost (per kilowatt hour).

The energy density per unit volume (Wh/l) and per unit weight (Wh/kg) of various rechargeable batteries is shown in [Fig. 1](#) (not all batteries fall within the ranges shown).

In the case of conventional batteries for instance, these systems contain a liquid electrolyte, generally a concentrated aqueous solution of potassium hydroxide or sulphuric acid. The use of aqueous battery electrolytes theoretically limits the choice of electrode reactants to those with decomposition voltages less than that of water, 1.23 V at 25 °C, although because of the high over potential normally associated with the decomposition of water, the practical limit is some 2.0 V. The liquid state offers very good contacts with the electrodes and high ionic conductivities but anion and cation mobilities are of the same order of magnitude and their simultaneous flow gives rise to two major problems: (i) corrosion of the electrodes, (ii) consumption of the solvent (water) by electrolysis during recharging and by corrosion during storage, making necessary periodic refilling. In addition, these two processes give off gases, thereby prohibiting the design of totally sealed systems.

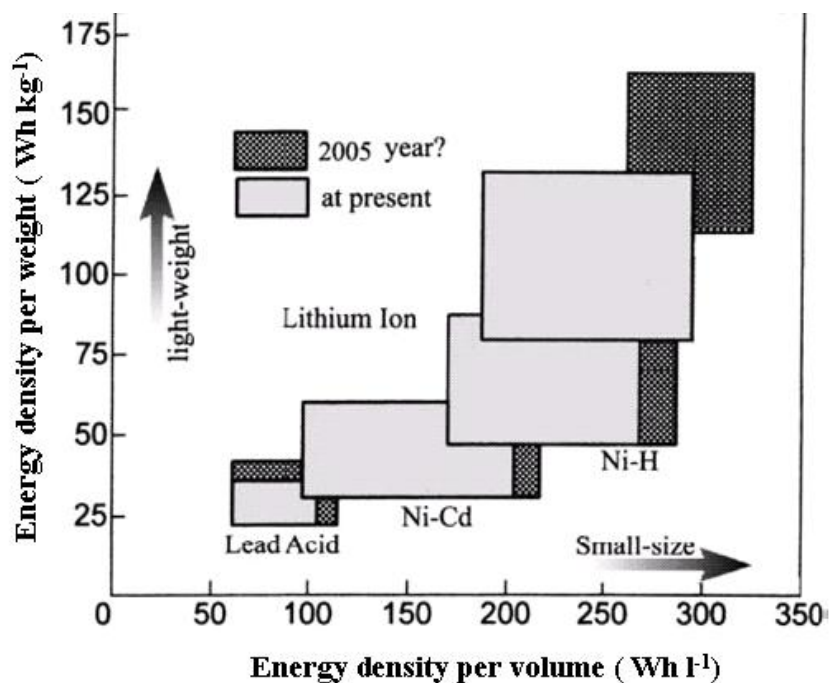

Fig.1. Energy density of secondary batteries

The resulting problems include leakage of the corrosive electrolyte and air entries which, even when kept to a minimum, deteriorate the electrolyte and the electrodes. A further drawback is the risk of electrode passivation; the formation of insulating layers of PbSO_4 , Zn(OH)_2 on the electrodes.

2. Solid state electrolytes

The demand for batteries with high energy densities has inevitably led to research and development of systems utilizing thermodynamically more stable to aqueous electrolytes. The essential requirements of an electrolyte are that:

- (1) It is ionically but not electronically conducting;
- (2) It is neither a solvent for the reactants nor, preferably, for the reaction product and
- (3) It has the decomposition potential greater than that of the chosen reaction product.

It is advantageous for the electrolyte to be inexpensive, non toxic and to have a low vapour pressure. In general these requirements can be met in three classes of compounds; (1) molten salts (2) ionically conducting solids and (3) organic liquids and low melting solids.

The concept of an all solid state battery is appealing since such a system would possess a number of desirable characteristics: e. g. absence of any possible liquid leakage or gassing,

the likelihood of extremely long shelf-life and the possibility of operation over a wide temperature range. Solid state batteries could be constructed with excellent packaging efficiency for the active components, without separators and using simple lightweight containers. The opportunities for extreme miniaturization and very simple fabrication techniques are of obvious importance in applications and reliability are key factors, as for example in implantable electronic instrumentation such as cardiac pacemakers, physiological monitoring /telemetry packages etc.

A solid electrolyte is a phase which has an electric conductance wholly due to ionic motion within the solid. Further, the only mobile charge carrier is the cation A^+ associated with an anion immobilized in a crystal lattice. Such phases have been known for over a century, but until recently all known materials of this type had high resistivities at ambient temperatures. This high internal resistance of the cells is a direct result of the lack of any ambient temperature solid with fast ion conduction. The most ionic conducting material at that time was AgI with a conductivity value of about 10^{-6} S/cm at 25 °C. Table 1 shows the five solid electrolyte batteries that were under development and as indicated the very high internal resistance ranging from 50 k Ω up to 40 M Ω . This restricted the development of solid electrolyte devices in a number of laboratory cells, used for thermodynamic studies, and of little interest in power sources.

At room temperature solid electrolytes did not conduct current very well. A value of 10^{-6} S/cm was a high value of conductivity for a solid electrolyte. A striking development occurred towards the end of 1960 with the discovery of a series of solids of general formula $M\text{Ag}_4\text{I}_5$ (M=Rb, K ...) having exceptionally high ionic conductivity ($> 10 \text{ Sm}^{-1}$ at room temperature).

Table 1. Solid state batteries as of the year 1960

System	Cell potential	Development organization
Ag/AgI/V ₂ O ₅	0.46	National Carbon
Ag/AgBr/CuBr ₂	0.74	General Electric
Ag/AgBr–Te/CuBr ₂	0.80	Patterson–Moos Research
Ag/AgCl/KICl ₄	1.04	Sprague Electric
Ni–Cr/SnSO ₄ /PbO ₂	1.2-1.5	P.R. Mallory & Rayovac

A number of structural features have been found to characterize solids with high ionic conductivity and to distinguish them from the more usual ionic crystals. Ionic conductivities of some solid state electrolytes are shown in Fig.2.

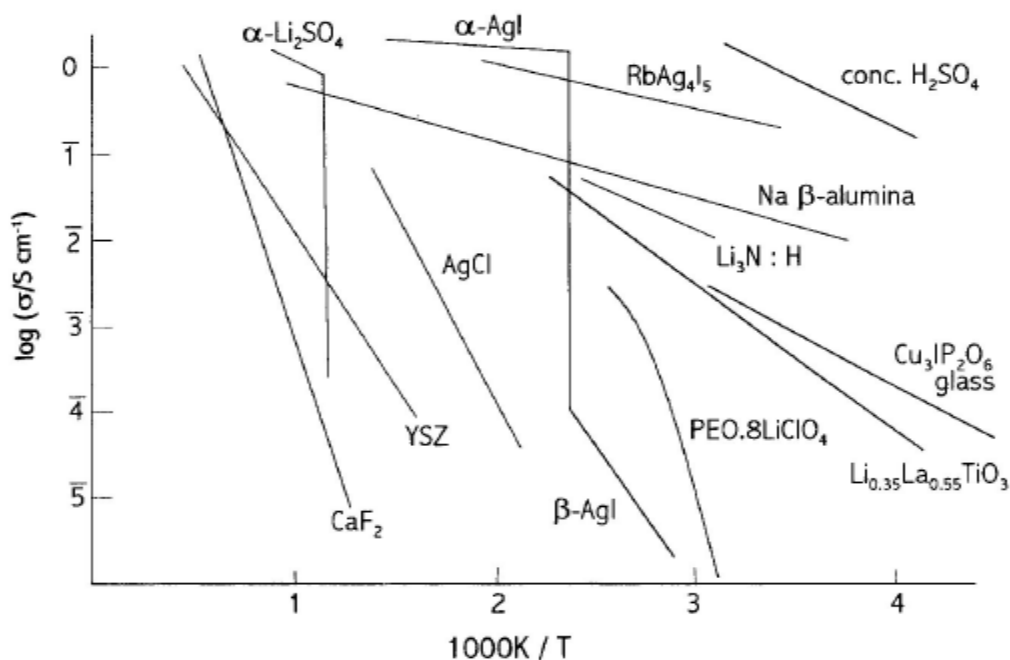

Fig.2. Ionic conductivity of some good solid electrolytes

The electrolyte is a solid fast ion conductor. The blocking of the anions prevents passivation, corrosion and solvent electrolysis reactions. Consequently there is no gas formation. It is therefore possible to design totally sealed batteries, eliminating the deterioration of the electrolyte and the electrodes by the outside environment. Under these conditions, the electrolyte can coexist with couples which are highly reducing at the negative electrodes and highly oxidizing at the positive electrode. In such systems higher energy densities can be achieved.

2.1. Ionic conductivity in solids electrolytes (Fast ion conductors)

Point defects are responsible for possible movements of atoms or ions through the structure. If a crystal structure is perfect it would be difficult to envisage how the atoms move, either by diffusion through the lattice or ionic conductivity (ion transport under the influence of an external electric field). There are two possible mechanisms for the movement of ions through a lattice: vacancy mechanism (it can be described as the

movement of a vacancy rather than the movement of the ion) or interstitial mechanism where an interstitial ion jumps or hops to an adjacent equivalent site. This simple picture of movement in an ionic lattice are known as the hopping model (Fig.3.).

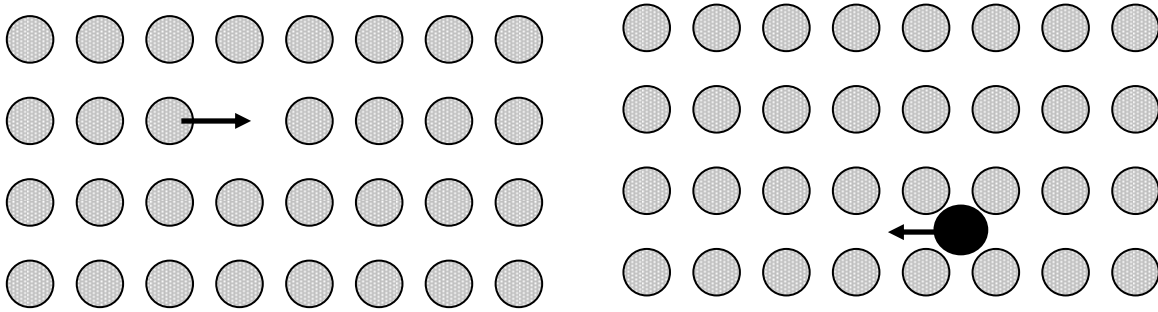

Fig.3. Ion motion via point defects (a) mobile vacancy (b) mobile interstitial

Ionic conductivity σ is defined in the same way as electronic conductivity

$$\sigma = n q \mu$$

where n is the number of charge carriers per unit volume, q is their charge and μ is their mobility, which is a measure of the drift velocity in a constant electric field. This equation is a general equation defining conductivity in all conducting materials. In order to understand why some ionic solids conduct better than others it is useful to look at the definition more closely in terms of the hopping model. In the case of crystals where the ionic conductivity is carried by vacancy or interstitial mechanism, the concentration of charge carrier n will be closely related to the concentration of defects in the crystal, and μ will thus refer to the mobility of these defects in such cases. Fast ion transport in crystalline solids appears to be limited to compounds in which either Group IA or IB cations or Group VI-A or VII-A anions are mobile, with cation conductors being far more numerous. Typical examples of compounds in each of these categories include α -AgI, Na β -Al₂O₃, cubic stabilized ZrO₂ and β -PbF₂ respectively.

3. Solid state batteries

A solid-state battery is an energy converter transforming chemical energy into electrical energy by means of internal electron exchange. The electron transfer is mediated by mobile ions released from an ion source, the anode, and neutralized in the electron exchanger, the cathode. The positive ion is transmitted through a dielectric, which is a

good electronic insulator, the separator. The ideal solid-state battery should be based on one unique material in which three regions, corresponding to the ion source, the separator and the electron exchanger, are separated only by internal homo junctions. The conventional structure of the battery available today is shown in Fig.4.

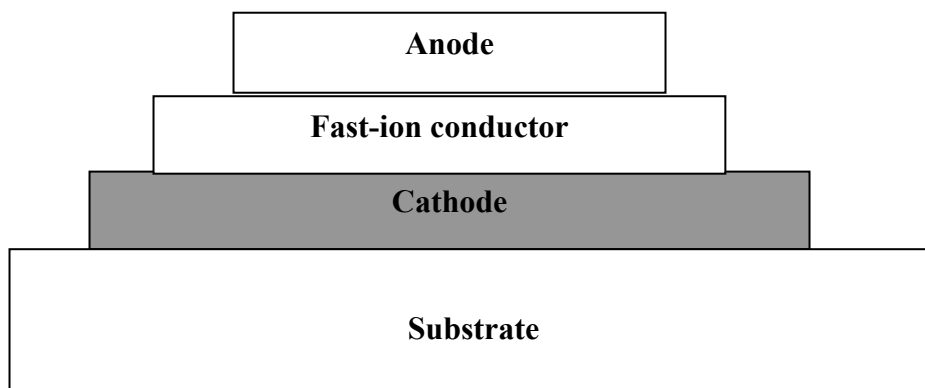

Fig.4. Schematic representation of the construction of a solid-state micro battery.

The materials constituting the electrochemical cell are the ion source (anode), the separator and the electron exchanger (cathode). The anode emits positive ions into the separator and supplies the external circuit with electrons obtained from the oxidation process. The ion-conducting separator is permeable only to the positive ions. The electron exchanger allowing the reduction process accepts electrons from the external circuit and positive ions through intercalation.

The discharge of the battery occurs when the battery is connected to an external load with the metal ion source as negative and the intercalation compound as positive. An electrochemical cell is then formed and the spontaneous oxidation-reduction reaction is a source of electrical energy.

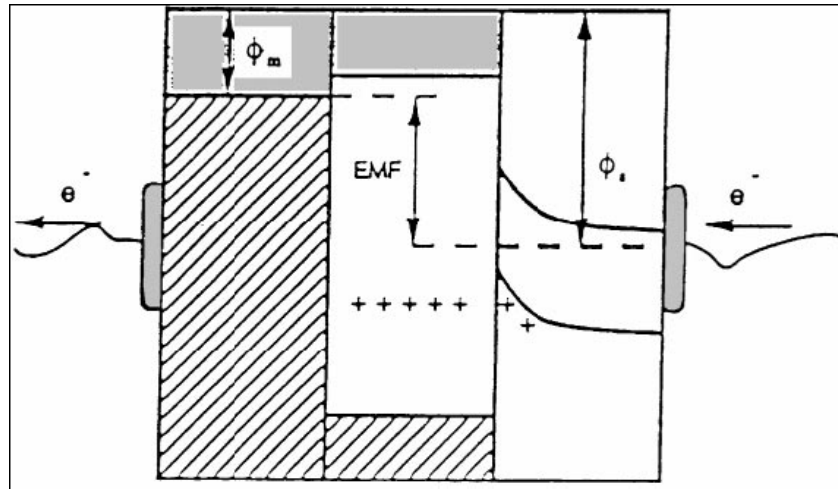

Fig.5. Schematic representation of the energy band diagram of a solid-state battery.

Table 2. Chronology of solid electrolyte batteries (1950-1990)

Date	Electrolyte	Log (S/cm)	Typical cell system
1950-60	AgI	-5	Ag/V ₂ O ₅
1960-65	Ag ₃ SI	-2	Ag/I ₂
1965-70	RbAg ₄ I ₅	-0.5	Li/Me ₄ NI ₅
1970-75	LiI	7	Li/I ₂ (P2VP)
1970-75	LiI(Al ₂ O ₃)	5	Li/PbI ₂
1970-75	β-alumina	1.5	Na-Hg/I ₂ ,PC
1980-85	LiI _a O _b S _c P _d	-3	Li/TiS ₂
1978-85	LiX-PEO	-7	Li/V ₂ O ₅
1983-87	MEEP	-4	Li/TiS ₂
1985-90	Plasticized SPE	-3	Li/V ₆ O ₃

When the cell is connected to an external load, electrons are extracted from the metal and flow into the external circuit. Positive ions are injected into the separator and diffuse toward the insertion material cathode. Once transferred into the cathode the positive ions are distributed near the surface to form a space charge layer. The quasi-Fermi level now depends on the distribution of charges in each material. A very thin layer of negative

charge is formed at the metal-insulator surface to compensate for the positive charges distributed throughout the insulator. A space charge layer is formed in the semiconductor interface to account for the ion injection into the intercalation compound. The energy band diagram for a solid-state battery is represented in Fig.5.

It is convenient to classify solid state batteries into four classes: high temperature, polymeric, lithium and silver. A summary of the chronology of solid state electrolytes and ambient temperature solid state batteries that were investigated during 1950 to 1990 is given in Table 2.

3.1. High temperature cells

The alkali metals lithium and sodium are attractive as battery anodes on account of their high electrode potentials and low atomic masses, which together result in excellent values for the battery specific energy. Batteries that consists of solids (fast ion conductors) or fused salts as electrolytes and which operate at temperatures of 200-500 °C are considered.

3.2. Silver ion batteries

AgI exhibits an unusually high ionic conductivity at elevated temperatures which decreases ~20% upon melting. Silver iodide is known to go through a phase transition at 146 °C to the high conducting phase, which is accompanied by an increase in conductivity of three orders of magnitude. Attempts to stabilize the high temperature α -AgI phase to room temperature by substituting foreign ions or complexes for either silver or iodine have been rather successful. These modified AgI conductors are classified in the following categories,

- (a) Anion substituted; e.g., S^{2-} , PO_4^{3-} , $P_2O_7^{4-}$, SO_4^- , WO_4^- ,
- (b) Cation substituted; e.g., K^+ , Rb^+ , or NH^+ ions to produce the MAg_4I_5 class of compounds,
- (c) Mixed ion substituted; e.g., the ternary system AgI-HgI₂-Ag₂S.

Other Ag conducting FICs based on the silver chalcogenides (Ag_2X , X = S, Se, Te) have been developed in a like manner.

The first commercial solid-state battery was manufactured at the end of the 1960's in the USA by Gould Ionics: this was a silver-iodine battery using $RbAg_4I_5$. Silver halides and rubidium silver iodide provide a very high Ag^+ ion conductivity. $RbAg_4I_5$ exhibits a

conductivity of $27 \Omega^{-1}\text{cm}^{-1}$ at 25°C , which is the highest value for all solid electrolytes at room temperature. A schematic diagram of the cell providing power to an external circuit is shown in Fig. 6.

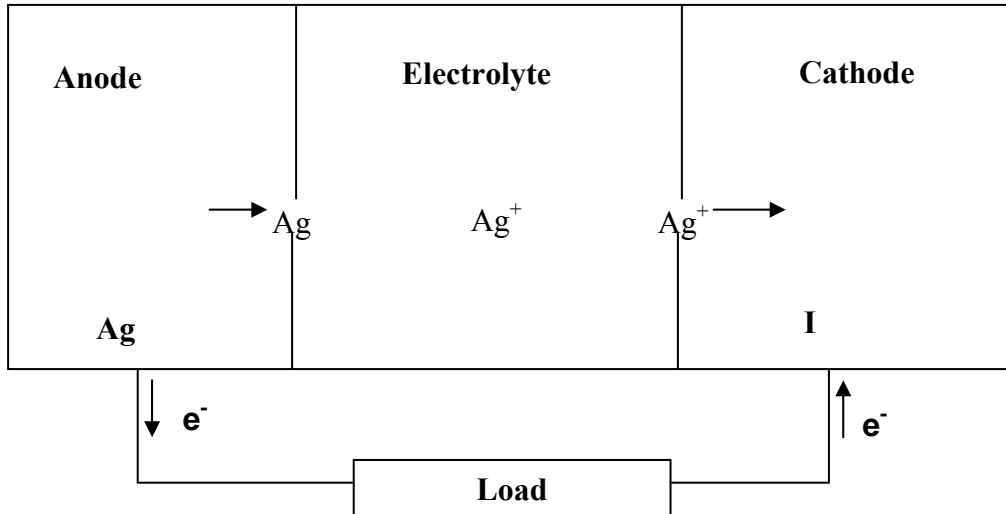
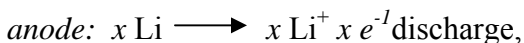

Fig. 6. Schematic diagram of silver ion, solid-state battery

3.3. Solid-state primary lithium batteries

A major shortcoming of silver-based solid electrolytes, which limits galvanic cell voltages, is their low decomposition potentials. An electrolyte with room temperature conductivity approaching that of the silver compounds and possessing a high decomposition potential would open up a wide range of applications. Many compounds have been studied with that goal in mind. One such material is lithium iodide.

With its low density (0.53 g cm^{-3}), low electro negativity, and high electron/atom mass ratio, lithium has become the preferred choice for the active element of the anode, which on discharge functions as an electron donor according to



where Li enters the electrolyte and the electron exits the anode to the external circuit to power the load. The elemental lithium is typically present in a host insertion material; most commonly a lithiated carbon such as Li_xC_6 . Fig. 7 shows a schematic representation of a lithium battery in discharge mode.

The *lithium-iodine battery* has been used to power millions of cardiac pacemakers since its introduction in 1972. The lithium-iodine has established a record of reliability and performance unsurpassed by any other electrochemical power source. This battery has a solid anode of lithium and a polyphase cathode of poly-2-vinylpyridine which is largely iodine (at 90% by weight). The solid electrolyte is a thin LiI film. The cell has an open-circuit voltage of 2.8 V and the energy density is 100 – 200 Wh kg⁻¹. These batteries have extended life time of 10 years for 150 to 250 mA h capacities.

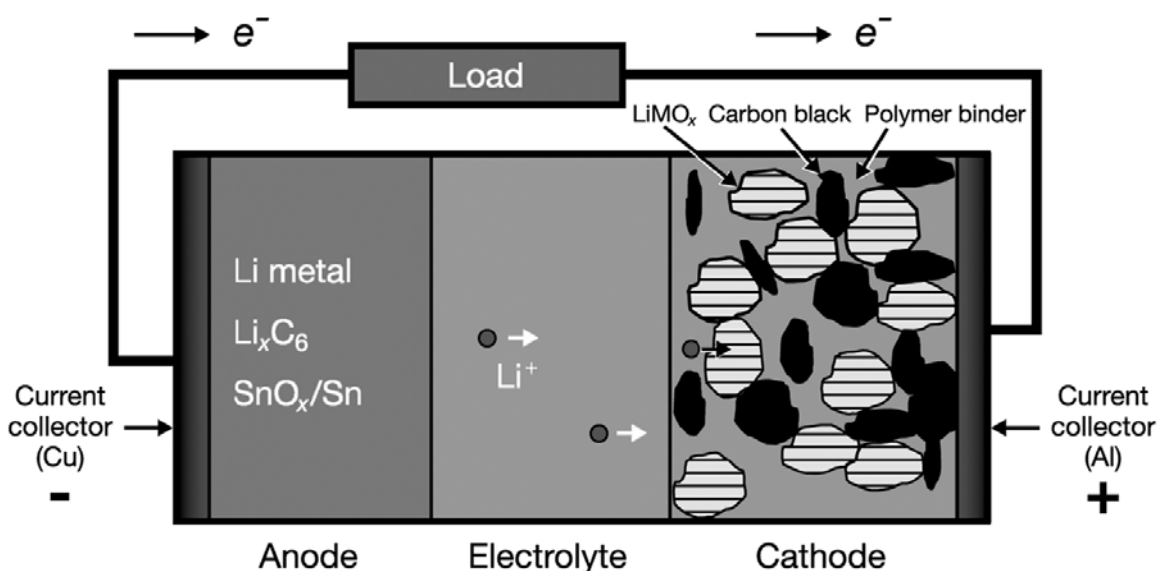

Fig. 7. Schematic representation of a rechargeable lithium battery in discharge mode.

The main problem areas in primary solid state batteries have been identified as: (i) volume changes, (ii) electrolyte impedance, (iii) discharge product impedance, (iv) materials compatibility and (v) manufacturability. Solid-state primary batteries can provide generally very long-life at low currents. Another example of such batteries is the lithium-glass batteries whose envisaged applications are mainly as power sources in electronic computers for CMOS memory back up.

3.4. Sodium batteries

Sodium is most attractive as a negative electrode reactant on account of its high electrochemical reduction potential of 2.271 V. When coupled with an appropriate electropositive material, it is capable of giving a cell of voltage >2 V. Moreover, sodium

is abundant in nature, cheap and non-toxic. It is also of low atomic mass (23.0) and the combination of high voltage and low mass leads to the possibility of a battery of high specific energy. The realization of a practical battery based on sodium depended upon identifying a suitable non aqueous electrolyte. The sodium sulphur battery is the best developed solid electrolyte battery. It comprises a molten sodium negative electrode and a molten sulphur positive electrode separated by a sodium ion conducting solid. Sodium β - and β' -alumina are non stoichiometric aluminates, that typically are synthesized from NaO and alumina.

Sodium beta alumina is highly conductive towards Na^+ ions at 300 °C, while being a good electronic insulator. This gave rise to the possibility of a solid ceramic electrolyte.

The cell discharges in two steps as Na^+ ions pass through the beta alumina to the sulphur electrode:

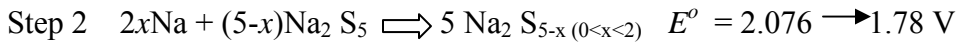

In the first step, sodium polysulphide (Na_2S_5) is formed as a liquid, immiscible with liquid sulphur. The open circuit voltage is therefore invariant at 2.076 V. Once all the sulphur has been converted to Na_2S_5 , an ionic conducting liquid, further discharge to Na_2S_3 takes place in a single phase and therefore the voltage declines linearly to 1.78 V at the composition Na_2S_3 . These reactions are fully reversible on recharge. The sodium aluminum oxide phase diagram is complex and a great deal of work has gone into optimizing sodium beta alumina ceramic for this application.

The sodium sulphur cell, shown schematically in Fig. 8, can store several times more energy per weight and volume than a conventional lead acid battery. Typical characteristics at 300 °C are with an open circuit Voltage of 2.18 V, an energy density of 200 W h kg^{-1} and a capacity of 15 A h. When cells are assembled into a battery, this figure will be degraded and a value of 150 W h kg^{-1} for a complete battery should be attainable. Despite their very intensive development, sodium sulphur batteries are essentially dead because of the inability to maintain a consistent quality. It is possible to replace β -alumina by a Na--conducting borate glass and other materials such as Nasicon of composition $\text{Na}_{1-x}\text{Si}_x\text{Zr}_2\text{P}_{3-x}\text{O}_{12}$ (with $1.8 < x < 2.4$) have been crystal engineered to maximize conductivity and ease of fabrication .

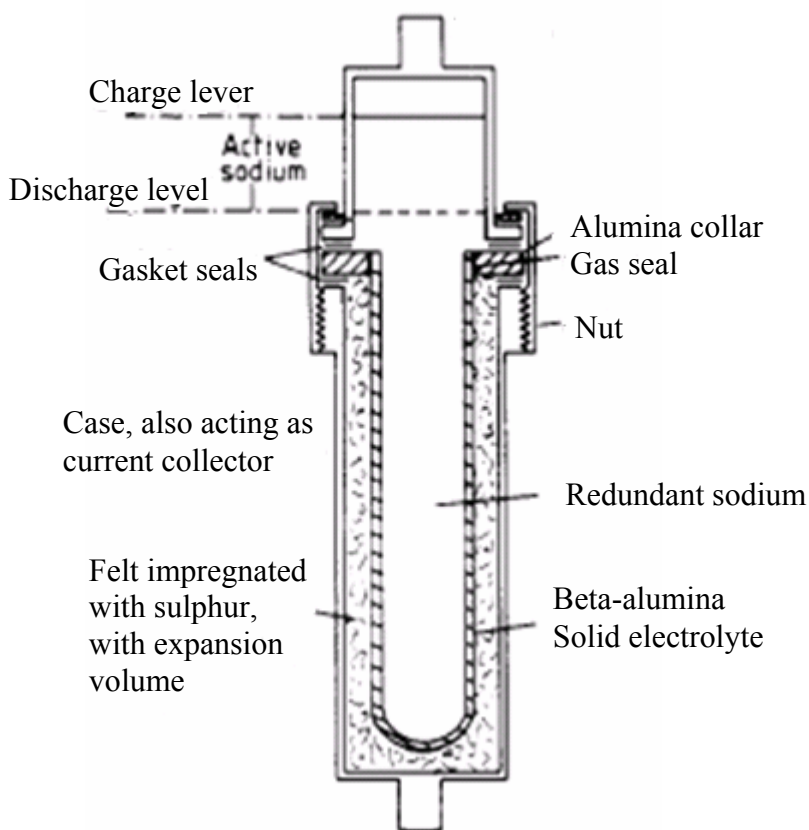

Fig.8. Schematic of sodium/ sulphur cell

3.5. Solid state secondary lithium batteries

3.5.1. Lithium iron sulphide batteries

One of the very few examples of a commercial solid state battery is the lithium heart pacemaker power source, but many systems of potential applicability have been proposed during the last 15 years. The Solid-state rechargeable batteries are with very low capacity, generally of the order of mille Ampere hours, and yet research and development effort are engaged, the target is the CMOS memory back up. Variety of solid electrolytes and intercalation cathode materials are used. The general structure of the cell is solid lithium anode, fast- ion conducting glass electrolyte and layered intercalation compound cathode. An example is the cell $\text{Li}/\text{LiBF}_4 - \text{PC}/\text{CF}_x$ with a cell voltage of 2.8 V and energy density 320 Wh kg^{-1}

The lithium iron sulphide battery operates at 400-500 °C using a fused halide eutectic electrolyte immobilized in the pores of a suitable separator. The most commonly used electrolytes are the LiCl-KCl binary eutectic and the LiF-LiCl-LiI ternary lithium halides. With Li-Al alloy anodes, two distinct voltage plateaus are observed at 1.6 and 1.35 V. Most development work has concentrated on the LiAl/FeS couple and the Varta Battery Company has produced a series of 140 A h cells with a specific energy of 100 W h kg⁻¹ at low discharge rates of 80 mA cm⁻², falling to 50 W h kg⁻¹ at high rates of 250 mA cm⁻². There are still a number of unresolved scientific questions on the chemistry of LiAl/FeS cells and the mechanism of the degradation and failure. In this system the separator is clearly a crucial component which must not only keep the electrode materials apart but also allow good permeation of the electrolyte and the most suitable materials are found to be boron nitride and zirconia in the form of woven cloths but there are obviously very expensive options.

3.5.2 Polymeric batteries

Polymer electrolyte batteries have been under development for cells operable at elevated temperatures (60-140°C). An experimental battery uses a thin electrolyte film made from a polymer such as polyethylene oxide (PEO) to separate the lithium electrode from an ion-insertion-type electrode such as V₆O₁₃, TiS₂ or V₃O₈.

In many developmental cells, the positive electrode (cathode) is a composite and consists of small particles of insertion compound bound together with polymer electrolyte and carbon which improves its electronic conductivity (Fig. 9). The composite electrode (50-75 μm thick) is deposited on a thin copper or nickel current collector less than 25 μm and a film (25-50 μm) of [(C₂H₄O)₉ LiF₃CSO₃]_n, polymer electrolyte completes the lithium cell. Another possibility is to roll the cell assembly. A cell of this type using V₆O₁₃ as the composite positive electrode would have a potential of about 2.8 V. During discharge, at currents of around 1 mA cm⁻² the voltage stabilizes around 2 V. The practical energy density is in the order of 200 W h kg⁻¹, the power density reaching 0.1 W g⁻¹. The main application envisaged is storage batteries for all electric vehicles.

The immediate advantages, expected from polymer technology in electrochemistry, are good mechanical properties, easy processing and lightweight materials.

The polymer salt phases transform to resistive phases at lower temperatures and consequently little development has been reported at normal ambient temperatures. Cells have been reported, operated at 26 °C with MoO₂ cathodes from which it is projected that energy densities in the range 0.1-0.2 W h cm⁻³ may be achieved

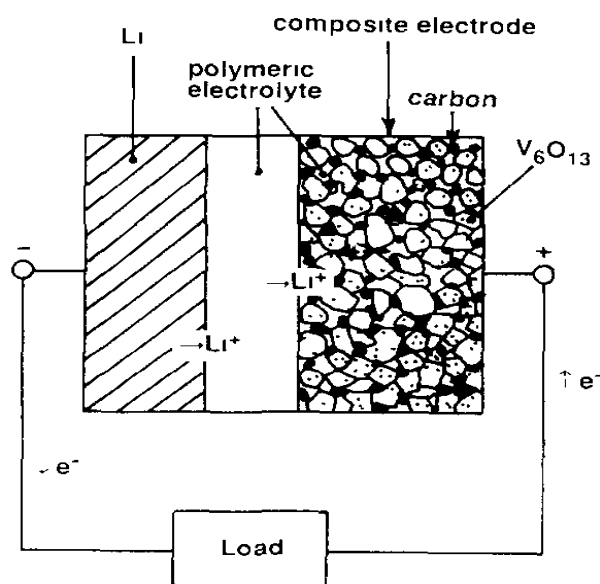
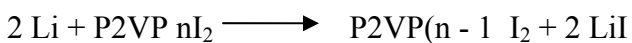

Fig.9. Schematic representation of a polymeric lithium cell using a composite electrode.

3.5.3. Lithium halogen batteries

The theoretical specific energy for the Li/LiI/I₂ (P2VP) cell is 1.9 W h cm⁻³ commercially available lithium/iodide batteries have a solid anode of lithium and a polyphase cathode (poly-2-vinyl pyridine) which is largely iodide (at 90% by weight). The discharge reaction is



This cell has an open circuit voltage of 2.8 V. The electrolyte ionic conductivity is $6.5 \times 10^{-7} \text{ S cm}^{-1}$ at 25 °C, and the energy density is 100-200 W h kg⁻¹.

Batteries of medium capacities (up to around 1 A h) can be used for random access memory power supplies in electronics. Similar batteries using Li/Br have also been built. The greater electronegative bromine gives rise to voltages of the order of 3.5 V and

energy densities are as high as 1.25 W h cm^{-3} . Their practical application is however limited by the limited conductivity of the LiBr films formed.

3.6. Thin film batteries using copper ion conductors

Although copper ion conducting materials are well known, applications in thin film micro batteries are very rare. One example is a battery with bimetal electrodes sandwiching a Cu- conductor. The latter was prepared by an electrolytic deposition method giving a CuI- CuCl mixture on a copper anode surface. Many other metals could be used on the other side. In all cases a low voltage was obtained, between 0.26 V (chromium) and 1.3 V (magnesium).

3.7. Lead-cupric fluoride thin layer batteries

This is a system which is interesting mainly because of its concentration and its method of fabrication. The cell is based on the fluoride ion solid conductor, $\beta\text{-PbF}_2$. The ionic conductance of this material is low at room temperature ($\sim 5 \times 10^{-5} \text{ Sm}^{-1}$). In this cell lead metal used is the negative electrode, PbF_2 is the electrolyte and CuF_2 is the positive electrode. Because of the high resistivity of CuF_2 , it was co-deposited with PbF_2 , to form a more conductive mixed layer. The reactions lead to a voltage of 0.7 V. A current density of up to 10 mA cm^{-2} could be obtained. This cell was not rechargeable. Other works are reported on micro batteries using PbFe (or derived structures) or other F conductors as the electrolyte.

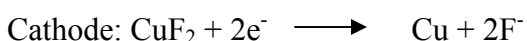
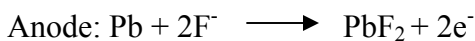

Lead was always the negative electrode and BiF_3 often the positive electrode. In these cases the system was rechargeable. Current densities of $40 \mu\text{A cm}^{-2}$ at 0.2 V were obtained. More recently the use of an evaporated mixture of PbF_2 , and LiF as the electrolyte was mentioned.

So far, the diverse research activities that led to the development of cathode and anode active materials, separator, electrolyte, current collector (metal foil; cathode is aluminum foil and anode Cu foil), material optimization and possible materials for use in a lithium ion battery have been described.

4. Manufacturing process

The manufacturing processes consist of (1) mixing the cathode or anode materials with binder and conductive additive, (2) painting on the current collector (metal foil), (3) drying and (4) pressing. The next step involves (1) assembly of cathode, anode and the simultaneous rolling-up with separator, (2) electrode insertion, (3) electrolyte injection into the battery case and (4) sealing.

In the electrode manufacturing process, a mixture of active materials with conductive additive such as acetylene black or Ketjen black, and a binder such as Teflon or polyvinylidene fluoride (PVF) dissolved in *n*-methyl-2-pyrrolidinone (NMP) are made in the form of a paste. The paste is painted over both sides of metal foil, dried and roll-pressed. Then it is cut to the desired width. In the case of polymer lithium batteries, after carrying out direct polymerization of the gel electrolyte sheet, roll-press is carried out over the cathode and anode sheets which are then cut a suitable size, wrapped in aluminum lamination film and heat welded at the edges (Fig.10).

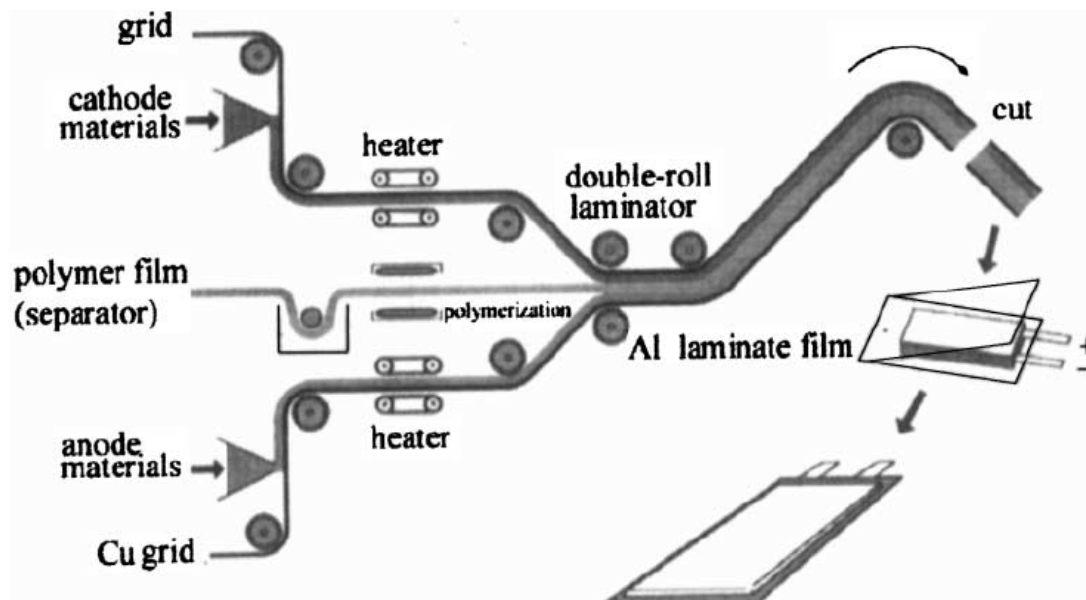

Fig.10. Schematic manufacture processing of lithium polymer battery

Finally, the battery is checked for short-circuit over 2–4 weeks. A protective thin film (SEI) will form at the anode–carbon interface during this period. Shipment inspection has to be conducted and the products shipped. Many battery manufacturing companies

worldwide have announced their involvement in large-scale production of lithium secondary batteries. However, the level of information released is limited and thus, it is impossible to evaluate the status of the different batteries at this stage.

References

1. A. Levasseur, M. Menetrier, R. Dormoy and G. Meunier, *Material Science and Engineering B*, 3 (1989) 512.
2. B. B. Owens P. M. Skarstad, *Solid State Ionics*, 53-56 (1992) 665-672
3. R.M. Dell, *Solid State Ionics*, 134 (2000) 139-158.
4. Vincent C.A., *Modern Batteries* (2nd Edition), Edward Arnold, London (1998).
5. Gabano J.-P. (Ed.), *Lithium Batteries*, Academic Press (1983)

Chapter – 9

FUEL CELLS

Ch. Venkateswara Rao

1. Introduction

During the past decade, fuel cells received enormous attention all over the world as novel electrical energy conversion systems. The major factor that influences the development of fuel cells over the last few years is the world wide concern on the environmental consequences of the use of fossil fuels in the production of electricity and for the propulsion of vehicles. The dependence of the industrialized nations on oil crisis and, recently, pressure on fossil fuels reserves is a cause of anxiety. More importantly however, is the increasing social awareness, over the last few decades, concerning issues of environmental pollution. The combustion of fossil fuels releases harmful emissions into air which influence the greenhouse effect as well as direct health problems of human beings. Major emissions of NO_x , SO_x , CO_2 and particulate matter are the cause of majority of the concern for pollution of the environment resulting in the increase of ozone level in the lower atmosphere, acid rain and warming of the atmosphere. Particulate matter or soot produced from combustion in vehicle engines, power plants and industrial processes can penetrate into the lungs and cause variety of health problems. There are several ways in which the emission by the human activities can be curbed and the dependence on the fossil fuels reduced without diminishing the standard of living. Besides, the enormous potential of saving energy, the efficiency of the end-use equipment, of vehicle propulsion engines as well as power generation facilities can be improved. The contribution of renewable energy sources from wind, sun and water could increase but the complete generation process should be taken into account when comparing different systems and these sources are not suited to cover the base load. Therefore, it appears that the solar energy or other renewable sources cannot meet the energy demand substantially. The future of the world is critically energy dependent. Many consider the effect of new technologies leading to the better utilization of the fuels, in addition to the use of solar and other renewable energies including the proper use of

atomic energy. The higher efficiencies and lower emissions make the fuel cells a valuable contribution to the power generation facilities, even though its contribution to the total energy demand may be minimal. All these issues indicate that the fuel cells appear to be one of the alternate energy sources that can cater to the needs of future world. The 19th century was considered to be the age of the Steam Engine while the 20th century is considered as the age of the Internal Combustion Engine and 21st century may come to be recognized as the age of the Fuel Cells.

The invention of fuel cells as an electrical energy conversion system is attributed to Sir William Grove; however, the principle was discovered by Christian Friedrich Schönbein. Sir William Grove mixed hydrogen and oxygen in the presence of an electrolyte, and produced electricity and water and called it as a gaseous voltaic battery. The invention, which later came to be known as a fuel cell did not produce enough electricity to be useful. In 1889, the term ‘fuel cell’ was first given by Ludwig Mond and Charles Langer, who attempted to build a working fuel cell using air and industrial coal gas. Although William Grove first demonstrated in 1839, it was used only in 1960 for space applications.

2. What is a fuel cell?

A fuel cell is an electrochemical energy converter that converts chemical energy of fuel into DC electricity, heat and water. Typically, a process of electricity generation from fuels involves several energy conversion steps, namely:

1. combustion of fuel converts chemical energy of fuel into heat,
2. this heat is then used to boil water and generate steam,
3. steam is used to run a turbine in a process that converts thermal energy into mechanical energy, and finally
4. mechanical energy is used to run a generator that generates electricity.

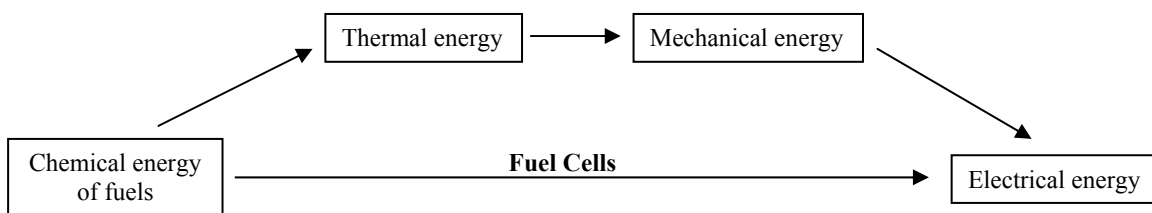

Scheme 1. Direct energy conversion with fuel cells in comparison to conventional indirect technology

A fuel cell circumvents all these processes and generates electricity in a single step without involving any moving parts. Such a device must be simpler, thus less expensive and far more efficient than the four-step process previously depicted.

Unlike conventional internal combustion engine, higher efficiencies are achievable in fuel cells as they do not suffer from Carnot's limitations. A fuel cell is in some aspects similar to a battery. It has an electrolyte, and negative and positive electrodes, and it generates DC electricity through electrochemical reactions. However, unlike a battery, a fuel cell requires a constant supply of fuel and oxidant. Also, unlike a battery, the electrodes in a fuel cell do not undergo chemical changes. Batteries generate electricity by the electrochemical reactions that involve the materials that are already in batteries. Because of this, a battery may be discharged, which happens when the materials that participate in the electrochemical reactions are depleted. Some batteries are rechargeable, which means that the electrochemical reactions may proceed in reverse when external electricity is applied - a process of recharging the battery. A fuel cell cannot be recharged as long as the reactants-fuel and oxidant-are supplied.

Fuel cells have many applications that make them attractive when compared with the existing conventional energy conversion technologies, namely:

- (i) Promise of high efficiency
- (ii) Promise of low or zero emissions
- (iii) Simplicity
- (iv) No moving parts and promise of long life
- (v) Quiet

Fuel and size flexibility

Because of their attractive properties, fuel cells have already been developed and come into widespread commercial use through three main applications: transportation, stationary power generation and portable applications.

3. Choice of fuel and oxidant

The choice and design of the fuel cell depend on the kind of fuel and oxidant adopted, operating temperature, power rating/conditioning and other usage requirements. A fuel-cell system that includes a fuel reformer can utilize the hydrogen from any hydrocarbon fuel, from natural gas to methanol, and even gasoline. Gaseous hydrogen has become the

fuel of choice for most applications, because of its high reactivity when suitable catalysts are used, its ability to be produced from hydrocarbons for terrestrial applications, and its high energy density (32 kWh/kg) when stored cryogenically for closed-environment applications, such as in space. Similarly, the most common oxidant is gaseous oxygen, which is readily and economically available from air for terrestrial applications and is also easily stored in a closed environment. In general, the oxygen needed by a fuel cell is generally supplied in the form of air.

4. How does a fuel cell works?

The basic physical structure or building block of most fuel cells consists of an electrolyte layer in contact with porous anode and cathode electrodes on either side. All fuel cells have similar basic operating principle. The input fuel is catalytically reacted (electrons removed from the fuel) in the fuel cell to create an electric current. The input fuel passes over the anode is catalytically split into electrons and ions. Air/oxygen passes over the

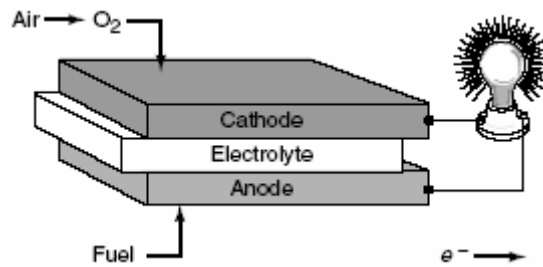

Fig.1. Schematic of a fuel cell

cathode is reduced by the electrons which are generated at anode and passed on to the cathode by external circuit. At cathode, the ions which are formed at anode and transported to cathode through the electrolyte, combine with the oxide ions and generate the oxidized product. If the fuel happens to be hydrogen, then water is formed.

4.1. Thermodynamical and kinetic aspects of electrochemical energy transformation

The energy storage and power characteristics of electrochemical energy conversion systems follow directly from the thermodynamic and kinetic formulations for chemical reactions as adapted to electrochemical reactions.

4.2. Thermodynamics

The basic thermodynamic equations for a reversible electrochemical transformation are given as

$$\Delta G = \Delta H - T\Delta S$$

where ΔG is the Gibbs free energy, or the energy of a reaction available for useful work, ΔH is the enthalpy, or the energy released by the reaction, ΔS is the entropy, and T is the absolute temperature, with $T\Delta S$ being the heat associated with the organization/disorganization of materials. The terms ΔG , ΔH , and ΔS are state functions and depend only on the identity of the materials and the initial and final states of the reaction.

Effect of temperature on free energy change (Gibbs–Helmholtz equation) is given by

$$\Delta G = \Delta H + T(\partial(\Delta G)/\partial T)_p$$

or

$$(\partial(\Delta G/T)/\partial T)_p = -\Delta H/T^2$$

Effect of pressure on free energy change is given by

$$(\partial(\Delta G)/\partial P)_T = \Delta nRT/P$$

The maximum electrical work (W_{el}) obtainable in a fuel cell operating at constant temperature and pressure is given by the change in Gibbs free energy (ΔG) of the electrochemical reaction:

$$\Delta G = -nFE \quad \text{---- (1)}$$

and

$$\Delta G^{\circ} = -nFE^{\circ} \quad \text{---- (2)}$$

where n is the number of electrons transferred per mole of reactants, F is the Faraday constant, being equal to the charge of 1 equiv of electrons, and E is the voltage of the cell with the specific chemical reaction; in other words, E is the electromotive force (emf) of the cell reaction. The voltage of the cell is unique for each reaction couple. The amount of electricity produced, nF , is determined by the total amount of materials available for reaction and can be thought of as a capacity factor; the cell voltage can be considered to be an intensity factor. The usual thermodynamic calculations on the effect of temperature, pressure, etc., apply directly to electrochemical reactions. Spontaneous processes have a negative free energy and a positive emf with the reaction written in a reversible fashion, which goes in the forward direction. The van't Hoff isotherm identifies the free energy relationship for bulk chemical reactions as

$$\Delta G = \Delta G^{\circ} + RT \ln(Q); Q = A_p/A_R$$

where R is the gas constant, T the absolute temperature and Q is the term dependent on the activity of reactants (A_R) and products (A_P).

Combining eq (1) and (2) with the van't Hoff isotherm, one obtain the Nernst equation for electrochemical reactions:

$$E = E^{\circ} - \frac{RT}{nF} \ln(Q)$$

According to the Nernst equation for hydrogen-oxygen reaction, the ideal cell potential depends on the cell temperature, pressure of reactants, etc. The impact of temperature on the ideal voltage, E , for the oxidation of hydrogen is shown in Fig. 2.

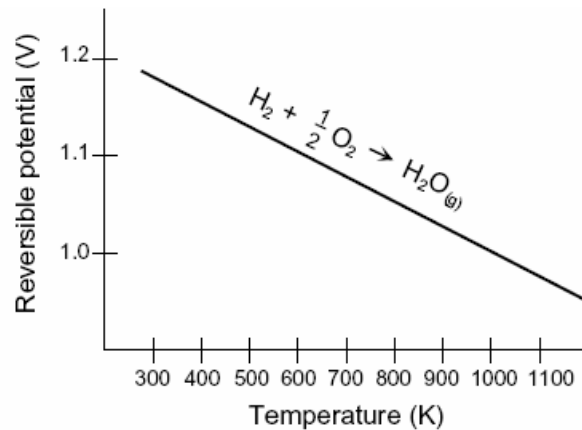

Fig.2. H_2/O_2 fuel cell ideal potential as a function of temperature

At a given temperature, the ideal cell potential can be increased by operating at higher reactant pressures, according to the equation

$$E = E^{\circ} + \frac{RT}{2F} \ln \left[\frac{P_{H_2}}{P_{H_2O}} \right] + \frac{RT}{2F} \ln \left[P^{1/2} O_2 \right]$$

and improvements in fuel cell performance have, in fact, been observed at higher pressures.

4.3. Kinetics

Thermodynamics describe reactions at equilibrium and the maximum energy release for a given reaction. Useful work (electrical energy) is obtained from a fuel cell only when a reasonable current is drawn, but the actual cell potential is decreased from its equilibrium potential because of irreversible losses. Figure 3 shows a typical voltage-current ($E - I$) discharge curve for a fuel cell with an open-circuit voltage E_{oc} . The overpotential $\eta = (E_{oc} - E)$ reflects the resistive IR losses due to the surface reaction kinetics, the resistance to transport of the working ion, H^+ or O^{2-} between the reductant and the oxidant reactive

sites, and the resistance to diffusion of the oxidant and/or reductant to the catalytic sites and their products away from these sites. At low currents, the performance of a fuel cell is dominated by kinetic losses. These losses mainly stem from the high overpotential of the reactions occurred at anode and cathode. At intermediate currents, ohmic losses arise from ionic losses in the electrodes and separator, although contact and electronic resistances can be important under certain operating conditions. At high currents, mass transport limitations become increasingly important. These losses are due to reactants not being able to reach the electrocatalytic sites. Typically, oxygen is the problem due to flooding of the cathode by liquid water, but protons and electrons can also cause mass-transfer limitations.

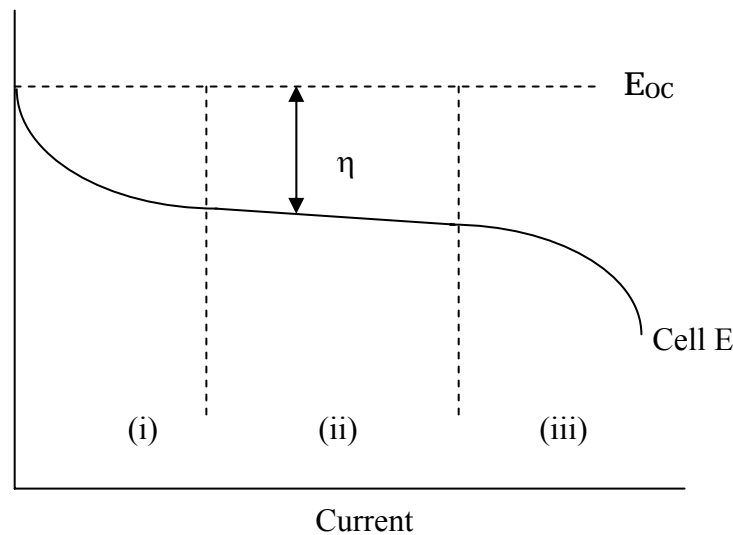

Fig.3. Typical polarization curve for a fuel cell: voltage drops due to: (i) surface reaction kinetics; (ii) electrolyte resistance; and (iii) reactant/product diffusion rates

At low current densities ($i_0 < 1 \text{ mA cm}^{-2}$), electrodes give a larger R_{tr} and therefore overpotential, η should be greater than 400 mV (at room temperature). An extremely active electrocatalyst is needed to overcome this initial voltage drop in the E versus current discharge curve. The goal of fuel cell developers is to minimize the polarization so that E_{cell} approaches E_{oc} . This goal is approached by modifications to fuel cell design (improvement in electrode structures, better electrocatalysts, more conductive electrolyte, thinner cell components, etc.). For a given cell design, it is possible to improve the cell

performance by modifying the operating conditions (e.g., higher gas pressure, higher temperature, change in gas composition to lower the gas impurity concentration). However, for any fuel cell, compromises exist between achieving higher performance by operating at higher temperature or pressure and the problems associated with the stability/durability of cell components encountered at the more severe conditions.

4.4. Fuel cell efficiency

The ideal or maximum efficiency of an electrochemical energy converter depends upon electrochemical thermodynamics whereas the real efficiency depends on electrode kinetics. The thermal efficiency of an energy conversion device is defined as the amount of useful energy produced relative to the change in stored chemical energy (commonly referred to as thermal energy) that is released when a fuel is reacted with an oxidant.

$$\varepsilon = \text{Useful energy}/\Delta H$$

In the ideal case of an electrochemical converter, such as a fuel cell, the change in Gibbs free energy, ΔG , of the reaction is available as useful electric energy at the temperature of the conversion. The ideal efficiency of a fuel cell, operating irreversibly, is then

$$\varepsilon = \Delta G/\Delta H$$

The most widely used efficiency of a fuel cell is based on the change in the standard free energy for the cell reaction, for example,

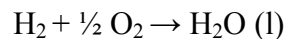

given by

$$\Delta G^{\circ} = G_{\text{H}_2\text{O}}^{\circ} - G_{\text{H}_2}^{\circ} - \frac{1}{2} G_{\text{O}_2}^{\circ}$$

where the product water is in liquid form. At standard conditions of 25 °C (298 K) and 1 atmosphere, the chemical energy (ΔH) in the hydrogen/oxygen reaction is 285.8 kJ/mole, and the free energy available for useful work is 237.1 kJ/mole. Thus, the thermal efficiency of an ideal fuel cell operating reversibly on pure hydrogen and oxygen at standard conditions would be:

$$\varepsilon_{\text{ideal}} = 237.1/285.8 = 0.83$$

The efficiency of an actual fuel cell can be expressed in terms of the ratio of the operating cell voltage to the ideal cell voltage. The actual cell voltage is less than the ideal cell

voltage because of the losses associated with cell polarization and the iR loss. The thermal efficiency of the fuel cell can then be written in terms of the actual cell voltage,

$$\begin{aligned}\varepsilon &= \text{Useful energy}/\Delta H = \text{Useful power}/(\Delta G/0.83) \\ &= (\text{Volts}_{\text{actual}} \times \text{Current})/(\text{Volts}_{\text{ideal}} \times \text{Current}/0.83) \\ &= 0.83 (\text{Volts}_{\text{actual}})/(\text{Volts}_{\text{ideal}})\end{aligned}$$

As mentioned, the ideal voltage of a cell operating reversibly on pure hydrogen and oxygen at 1 atm pressure and 25 °C is 1.229 V. Thus, the thermal efficiency of an actual fuel cell operating at a voltage of E_{cell} , based on the higher heating value of hydrogen, is given by

$$\varepsilon_{\text{ideal}} = 0.83 \times E_{\text{cell}}/E_{\text{ideal}} = 0.83 \times E_{\text{cell}}/1.229 = 0.675 \times E_{\text{cell}}$$

A fuel cell can be operated at different current densities, expressed as mA/cm² or A/ft². The corresponding cell voltage then determines the fuel cell efficiency. Decreasing the current density increases the cell voltage, thereby increasing the fuel cell efficiency. The trade-off is that as the current density is decreased, the active cell area must be increased to obtain the requisite amount of power. Thus, designing the fuel cell for higher efficiency increases the capital cost, but decreases the operating cost.

5. What are the various types of fuel cells?

A variety of fuel cells are in different stages of development. They can be classified by use of diverse categories, depending on the combination of type of fuel and oxidant, whether the fuel is processed outside (external reforming) or inside (internal reforming) the fuel cell, the type of electrolyte, the temperature of operation, whether the reactants are fed to the cell by internal or external manifolds. The most common classification of fuel cells is by the type of electrolyte used in the cells and includes 1) alkaline fuel cell (AFC), 2) phosphoric acid fuel cell (PAFC), 3) proton exchange membrane fuel cell (PEMFC), 4) direct methanol fuel cell (DMFC) 5) molten carbonate fuel cell (MCFC), and 6) solid oxide fuel cell (SOFC). These fuel cells are listed in the order of approximate operating temperature, ranging from ~353 K for PEMFC, 333-353 K for DMFC, ~373 K for AFC, ~273 K for PAFC, ~923 K for MCFC, and 1273 K for SOFC. The operating temperature and useful life of a fuel cell dictate the physicochemical and thermomechanical properties of materials used in the cell components (i.e., electrodes, electrolyte, interconnect, current collector.).

Aqueous electrolytes are limited to temperatures of about 200 °C or lower because of their high water vapor pressure. The operating temperature also plays an important role in dictating the type of fuel that can be used in a fuel cell. The low-temperature fuel cells with aqueous electrolytes are, in most practical applications, restricted to hydrogen as a fuel. In high-temperature fuel cells, CO and even CH₄ can be used because of the inherently rapid electrode kinetics and the lesser need for high catalytic activity at high temperature.

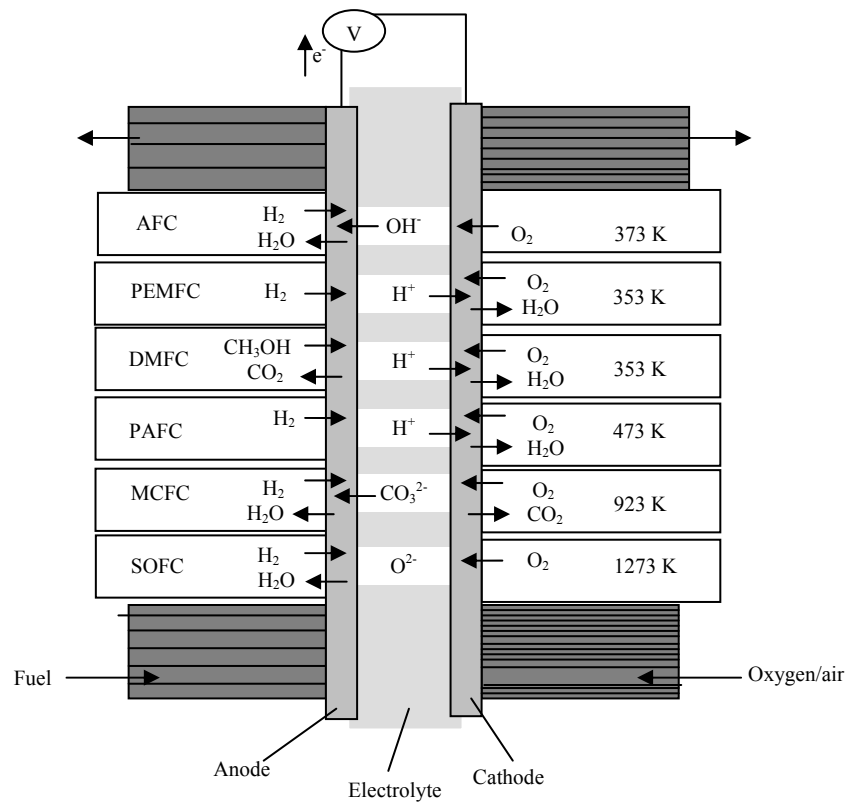

Fig. 4. Various types of fuel cells

The characteristic features of various types of fuel cells are shown in Table 1.

The heart of the fuel cell is membrane electrode assembly (MEA). The important components and their tasks are given in Table 2. A significant problem is the control of the interface at the junction of the reactant phase, the electrolyte medium, and the catalyzed conducting electrode, the so-called “three-phase boundary”, where the electrolyte, electrode, and reactant all come together. A stable three-phase boundary is

critical to good performance and long operation. Therefore, the porosity and the wetting behavior with electrolyte and the electrode surface must be precisely adjusted.

Table 1. Characteristic features of various fuel cells

Electrochemical device	Operating temp (K)	Electrolyte	Charge carrier	Electrolyte state	Fuel for cell	Oxidant for cell
Alkaline fuel cell (AFC)	333-423	45% KOH	OH ⁻	Immobilized liquid	Hydrogen	O ₂ /Air
Phosphoric acid fuel cell (PAFC)	453-493	H ₃ PO ₄	H ⁺	„	Hydrogen	O ₂ /Air
Proton exchange membrane fuel cell (PEMFC)	333-353	Ion exchange membrane (e.g., Nafion)	H ⁺	Solid	Hydrogen	O ₂ /Air
Direct methanol fuel cell (DMFC)	333-353	„	H ⁺	Solid	Methanol	O ₂ /Air
Molten carbonate fuel cell (MCFC)	923-973	Alkali carbonate mixture	CO ₃ ²⁻	Immobilized liquid	Hydrogen	O ₂ /Air
Solid oxide fuel cell (SOFC)	1073-1273	Yttria-stabilized zirconia	O ²⁻	Solid	Hydrogen	O ₂ /Air

The electrodes have to be gas (or liquid) permeable and therefore possess a porous structure. The structure and content of the gas diffusion electrodes is quite complex and requires considerable optimization for the practical application. The functions of porous electrodes in fuel cells are: 1) to provide a surface site where gas/liquid ionization or de-ionization reactions can take place, 2) to conduct ions away from or into the three phase interface once they are formed (so an electrode must be made of materials that have good electrical conductance), and 3) to provide a physical barrier that separates the bulk gas phase and the electrolyte. A corollary of first one is that, in order to increase the rates of reactions, the electrode material should be catalytic as well as conductive, porous rather than solid. The catalytic function of electrodes is more important in lower temperature fuel cells and less so in high temperature fuel cells because ionization reaction rates increase with temperature. It is also a corollary that the porous electrodes must be permeable to both electrolyte and gases, but not such that the media can be easily "flooded" by the electrolyte or "dried" by the gases in a one-sided manner.

Porous electrodes are key to good electrode performance.

Table 2. MEA (Membrane electrode assembly) components and their tasks

MEA component	Task/effect
Anode substrate	Fuel supply and distribution (hydrogen/fuel gas) Electron conduction Heat removal from reaction zone Water supply (vapour) into electrocatalyst
Anode catalyst layer	Catalysis of anode reaction Ion conduction into membrane Electron conduction into substrate Water transport Heat transport
Proton exchange membrane	Ion conduction Water transport Electronic insulation
Cathode catalyst layer	Catalysis of cathode reaction Oxygen transport to reaction sites Ion conduction from membrane to reaction sites Electron conduction from membrane to reaction sites Water removal from reactive zone into substrate Heat generation/removal
Cathode substrate	Oxidant supply and distribution (air/oxygen) Electron conduction towards reaction zone Heat removal Water transport (liquid/vapour)

The reason for this is that the current densities obtained from smooth electrodes are usually in the range of a single digit mA/cm² or less because of rate-limiting issues such as the available area of the reaction sites. Porous electrodes, used in fuel cells, achieve much higher current densities. These high current densities are possible because the electrode has a high surface area, relative to the geometric plate area that significantly increases the number of reaction sites, and the optimized electrode structure has favorable mass transport properties. In an idealized porous gas fuel cell electrode, high current densities at reasonable polarization are obtained when the electrolyte layer on the electrode surface is sufficiently thin so that it does not significantly impede the transport of reactants to the electroactive sites, and a stable three-phase (gas/electrolyte/electrode

surface) interface is established. When an excessive amount of electrolyte is present in the porous electrode structure, the electrode is considered to be "flooded" and the concentration polarization increases to a large value.

The porous electrodes used in low-temperature fuel cells (AFC, PAFC, PEMFC and DMFC) consist of a composite structure that contains platinum (Pt) electrocatalyst on a high surface area carbon black and a PTFE (polytetrafluoroethylene) binder. Such electrodes for acid and alkaline fuel cells are described by Kordesch et al [2]. In these porous electrodes, PTFE is hydrophobic (acts as a wet proofing agent) and serves as the gas permeable phase, and carbon black is an electron conductor that provides a high surface area to support the electrocatalyst. Platinum serves as the electrocatalyst, which promotes the rate of electrochemical reactions (oxidation/reduction) for a given surface area. The carbon black is also somewhat hydrophobic, depending on the surface properties of the material. The composite structure of PTFE and carbon establishes an extensive three-phase interface in the porous electrode, which is the benchmark of PTFE bonded electrodes.

In MCFCs, which operate at relatively high temperature, no materials are known that wet-proof, are retains porous structure against ingress by molten carbonates. Consequently, the technology used to obtain a stable three-phase interface in MCFC porous electrodes is different from that used in PAFCs. In the MCFC, the stable interface is achieved in the electrodes by carefully tailoring the pore structures of the electrodes and the electrolyte matrix (LiAlO_2) so that the capillary forces establish a dynamic equilibrium in the different porous structures. In a SOFC, there is no liquid electrolyte present that is susceptible to movement in the porous electrode structure, and electrode flooding is not a problem. Consequently, the three-phase interface that is necessary for efficient electrochemical reaction involves two solid phases (solid/electrolyte/electrode) and a gas phase. A critical requirement of porous electrodes for SOFC is that they are sufficiently thin and porous to provide an extensive electrode/electrolyte interfacial region for electrochemical reaction.

The essential criteria for a better electrode material are:

- high electronic conductivity
- high adsorption capacity of reactant and oxidant

- chemical and structural stability under the conditions employed in devices i.e., operating temperature, wide range of partial pressures of reactant and oxidant, concentration of electrolyte
- chemical and thermomechanical compatibility to electrolyte and interconnector materials
- high ionic conductivity
- ability to decompose the intermediate species formed during the oxidation/reduction process
- tolerant to contaminants e.g., halide ions, NO_x , CO_x , SO_x
- low cost of materials

Oxygen reduction reaction (ORR), which is a common cathodic reaction to all the fuel cell devices, has been studied over the years because of its fundamental complexity, great sensitivity to the electrode surface, and sluggish kinetics. The sluggish kinetics of ORR under the conditions employed in electrochemical devices is due to the low partial pressure of oxygen in air, slow flow rate of oxygen (i.e., less residence time for oxygen molecules on active sites) under ambient conditions. The main disadvantage in this important electrode reaction is the exchange current density (j_0) value in the region of 10^{-10} A/cm² in acidic medium and 10^{-8} A/cm² at 298 K in alkaline solution which is lower than the j_0 value of anodic reaction (10^{-3} A/cm²) in all the electrochemical devices. Hence (from the equation $\eta = RT/nF \ln(j/j_0)$) the oxygen reduction reaction usually contributes considerably to the overpotential and therefore results in a low efficiency in the functioning of electrochemical energy devices using air as oxidant. Understanding and exploitation of electrocatalysis for this reaction is needed more than any other reactions in electrochemical devices. Oxygen undergoes a two-step indirect reduction reaction. On most of the electrocatalysts, oxygen reduction takes place by the formation of high energy intermediate, H_2O_2 followed by further reduction to H_2O . The stable H_2O_2 intermediate is undesirable, as it lowers the cell voltage and H_2O_2 attacks and corrodes the carbonaceous electrode material commonly used. Better catalysts are needed to speed the decomposition of H_2O_2 to reduce its impact on the overall reaction. Similarly, a catalyst can enhance the fuel dissociation rate at the anode. In order to obtain maximum efficiency and to avoid corrosion of carbon supports and other materials by peroxide, it is

desired to achieve a four electron reduction. Finding suitable electrocatalysts that can promote the direct four electron reduction of oxygen molecule is an important task.

The characteristic features, advantages and limitations of various types of fuel cells are given below.

5.1. Alkaline fuel cells (AFCs)

The first commercial fuel cell systems were the AFCs that became available in the 1950s. AFCs were used to power the Apollo spacecrafts and are currently used in the Space Shuttles. The electrolyte in AFCs is a concentrated KOH solution. For low temperature applications (60-90 °C) the KOH concentration is 35-50 wt%. To achieve optimum performance of AFCs with KOH concentrations of 85 wt% the operating temperature was increased to 200 °C. These high temperature cells are also operated at high pressures (4-6 atm) to prevent the electrolyte solution from boiling.

Pure H₂ and O₂ are input as the fuel and oxidizer in an AFC. The gas diffusion electrodes are constructed of porous carbon and are doped with Pt to catalyze the oxidation and reduction reactions. The anodes contain 20% Pd in addition to the Pt and the cathodes contain 10% Au and 90% Pt. For higher temperature operations, Ni catalysts are also used. Ni is used for the inter connectors in an AFC stack. The AFC operates at up to ~1 A/cm² at 0.7 V.

The mobile ions in the system are the OH⁻ ions in the alkaline solution that are transported from the cathode, where reduction of O₂ occurs, to the anode, where oxidation of H₂ occurs. Water is produced at the anode. The following reactions define the operation of AFCs:

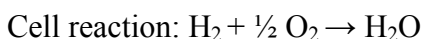

Although AFCs have the highest electrical efficiency of all fuel cell systems (60% LHV), they are extremely sensitive to impurities. The presence of N₂ and impurities in the gas streams substantially reduce the cell efficiency. The presence of even small amounts of CO₂ is detrimental to the long-term performance of AFCs because K₂CO₃ forms and inhibits gas diffusion through the carbon electrodes. The small amounts of CO₂ in air (~300 ppm) preclude the use of air as the oxidant in an AFC. This restriction limits the

use of these fuel cell systems to applications such as space and military programs, where the high cost of providing pure H₂ and O₂ is permissible. Because pure gases are used, AFCs can generate pure, potable water for consumption during space missions.

5.2. Phosphoric acid fuel cells (PAFCs)

Other than the AFCs, PAFCs are closer to commercialization than other fuel cell systems. The two intended commercial uses for PAFCs are 1) distributed power using reformed natural gas as a fuel; and 2) for small-scale, on-site cogeneration. Air is used as the oxidant. In contrast to the AFC, PAFCs are tolerant of CO₂ because concentrated phosphoric acid (H₃PO₄) is used as the electrolyte. Compared to other inorganic acids, phosphoric acid has relatively low volatility at operating temperatures of 150-220 °C. Protons migrate from the anode to the cathode through 100% H₃PO₄ that is immobilized in a SiC-poly(tetrafluoroethylene) matrix. Electrodes are made of platinized, gas permeable graphite paper. The water produced at the cathode is removed with the excess O₂ and the N₂. PAFCs have demonstrated excellent thermal, chemical, and electrochemical stability compared to other fuel cell systems. PAFCs are defined by the following reactions:

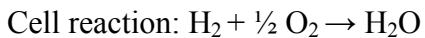
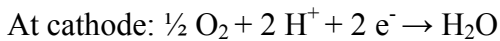
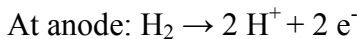

To optimize the ionic conductivity of the electrolyte, operating temperatures are maintained between 150-220 °C at pressures ranging from atmospheric to ~8 atm. Reduction of oxygen is slower in an acid electrolyte than in an alkaline electrolyte, hence the need for Pt metal in the electrodes to help catalyze the reduction reactions. CO poisoning of the Pt electrodes is slower at PAFC operating temperatures than at lower temperatures so up to 1% CO in the fuel gas produced during the reforming process can be tolerated. At lower temperatures CO poisoning of the Pt in the anode is more severe. Currently, Pt based materials were used as anode and cathode. The anode operates at nearly reversible voltage with ~0.1 mg/cm² catalyst loading. The cathode requires a higher catalyst loading of ~1 mg/cm² of catalyst. PAFCs are already semicommercially available in container packages (200 kW) for stationary electricity generation. Hundreds of units have been installed all over the world.

Aside from the CO produced during hydrocarbon reforming, the concentration of other impurities must be low compared to the reactants and diluents. Sulfur gases (mainly H₂S and COS) that originate from the fuel gas can poison the anode by blocking active sites for H₂ oxidation on the Pt surface. Molecular nitrogen acts as a diluent but nitrogen compounds like NH₃, HCN, and NO_x are potentially harmful impurities. NH₃ acts as a fuel, however, the oxidant nitrogen compounds can react with the H₃PO₄ to form a phosphate salt, (NH₄)H₂PO₄. Unacceptable performance losses can occur if the concentration of this phosphate salt in the electrolyte increases above 0.2 mole%.

5.3. Proton exchange membrane fuel cells (PEMFCs)

PEM fuel cells are a serious candidate for automotive applications, but also for small-scale distributed power generation, and for portable power applications as well. PEMFCs contain a proton conducting ion exchange membrane as the electrolyte material. The membrane material is a fluorinated sulfonic acid polymer commonly referred to by the trade name given to a material developed and marketed by DuPont - Nafion®. The acid molecules are immobile in the polymer matrix; however, the protons associated with these acid groups are free to migrate through the membrane from the anode to the cathode, where water is produced. The electrodes in a PEMFC are made of porous carbon cloths doped with a mixture of Pt and Nafion®. The catalyst content of the anode is ~0.1 mg/cm², and that of the cathode is ~0.5 mg/cm². The PEMFC operates at ~1 A/cm² at 0.7 V.

PEMFCs use H₂ as the fuel and O₂ as the oxidant. The PEMFC is insensitive to CO₂ so air can be used instead of pure O₂ and reforming hydrocarbon fuels can produce the H₂. Thermally integrating fuel reformers with operating temperatures of 700-800 °C with PEMFCs that operate at 80 °C is a considerable challenge. The PEMFC is defined by the following reactions:

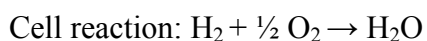
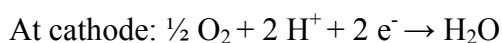
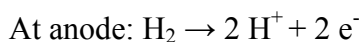

PEMFCs have received considerable attention lately as the primary power source in electric vehicles for several reasons. Since the electrolyte is a polymeric material, there is no free corrosive liquid inside the cell (water is the only liquid), hence material corrosion

is kept to a minimum. PEMFCs are also simple to fabricate and have a demonstrated long life. On the other hand, the polymer electrolyte (Nafion®) is quite expensive and Pt loadings in the electrodes are quite high so the fuel cell cost is high. The power and efficiency of a PEMFC is also dependent on the water content of the polymer electrolyte, so water management in the membrane is critical for efficient operation. The conductivity of the membrane is a function of the number of water molecules available per acid site and if the membrane dries out, fuel cell power and efficiency decrease. If water is not removed from the PEMFC the cathode can become flooded which also degrades cell performance. For high temperature PEMFCs, polybenimidazole based membranes will be preferred.

The required moisture content of the membrane is what limits the operating temperature of a PEMFC to less than 120 °C. This temperature ensures that the by-product water does not evaporate faster than it is produced. Low operating temperatures equates to high Pt loadings in the electrodes to efficiently catalyze the oxidation and reduction reactions. The Pt content of the electrodes also necessitates that the CO content of the fuel gas be very low (< 5 ppm) because CO blocks the active sites in the Pt catalyst. Therefore, if a hydrocarbon reformer is used to produce H₂, the CO content of the fuel gas needs to be greatly reduced. This is usually accomplished by oxidation of CO to CO₂, using a water gas shift reactor, or using pressure swing adsorption to purify the hydrogen.

5.4. Direct methanol fuel cells (DMFCs)

The DMFC uses the same basic cell construction as for the PEMFC. It has the advantage of a liquid fuel in that is easy to store and transport. There is no need for the reformer to convert the hydrocarbon fuel into hydrogen gas. Methanol is the liquid fuel having high energy density (6.2 kWh/kg) among all the liquid fuels and next to hydrogen. The anode feedstock is a methanol and water mixture or neat methanol, depending on cell configuration. The DMFC is under development as a power source for portable electronic devices such as notebook computers and cellular phones. The pure methanol or a methanol-water mixture would be stored in a cartridge similar to that used for fountain pens. Refueling would involve the quick replacement of the cartridge. The reaction for the direct conversion of methanol has a similar voltage as for hydrogen.

DMFCs use CH_3OH as the fuel and O_2 as the oxidant. Due to the chemical similarity of water and methanol, the methanol has considerable solubility in the polymer membrane, leading to significant crossover from the anode side to the cathode side of the cell. On reaching the cathode, the methanol is oxidized. This significantly lowers the cathode voltage and the overall efficiency of cell operation. The typical DMFC yields ~ 0.5 V at 400 mA/cm^2 at 60°C . The DMFC is defined by the following reactions:

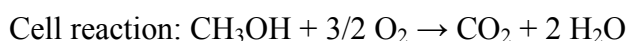
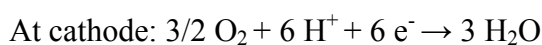
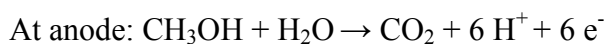

The main disadvantage of the DMFC system is the relative low power density, which has to be significantly improved if the DMFC should be a viable alternative to the PEMFC plus reformer system. The lower cell performance of a DMFC is caused by the poor kinetics of the anode reaction. The oxidation reaction proceeds through the formation of carbon monoxide as an intermediate which strongly adsorbs on the surface of a Pt catalyst. Therefore, a potential, which is more anodic than the thermodynamic value, is needed to obtain a reasonable reaction rate. In contrast to the PEMFC, where it is mainly the cathode that is kinetically hindered, both electrodes of a DMFC suffer from kinetic losses. Consequently, numerous materials were studied to find an electrode material that displays an enhanced catalytic activity and therefore lower overpotentials towards the methanol oxidation. At present, the most active anode catalysts are based on Pt–Ru alloys. Ruthenium reduces the poisoning effect by lowering the overpotentials at the anode and thus increases considerably the catalytic activity of pure platinum. The platinum-ruthenium catalyst loadings for the anode are higher than for the PEMFC and are in the range of $1\text{--}3 \text{ mg/cm}^2$. Cathode catalysts are based on Pt and Pt alloys (Pt-M where $\text{M} = \text{Cr}, \text{Co}, \text{Fe}$ and Ni).

5.5. Molten carbonate fuel cells (MCFCs)

MCFCs contain an electrolyte that is a combination of alkali (Li, Na, and K) carbonates stabilized in a LiAlO_2 ceramic matrix. The electrolyte should be pure and relatively free of alkaline earth metals. Contamination by more than 5-10 mole % of CaCO_3 , SrCO_3 , and BaCO_3 can lead to performance loss. Electrons are conducted from the anode through an external circuit to the cathode and negative charge is conducted from the cathode through

the electrolyte by CO_3^{2-} ions to the anode. Water is produced at the anode and removed with CO_2 . The CO_2 needs to be recycled back to the fuel cell to maintain the electrolyte composition. This adds complexity to the MCFC systems. The oxidation and reduction reactions that define MCFC operation are as follows:

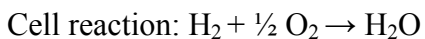
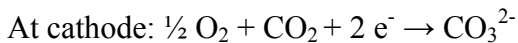
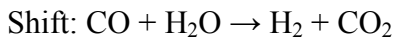
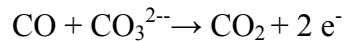
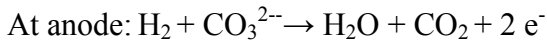

MCFCs typically operate at temperatures between 600-700 °C providing the opportunity for high overall system operating efficiencies, especially if the waste heat from the process can be utilized in the fuel reforming step or for cogeneration. Operating temperatures higher than 700 °C lead to diminishing gains in fuel cell performance because of electrolyte loss from evaporation and increased high temperature materials corrosion. Typical operating parameters are $\sim 150 \text{ mA/cm}^2$ at 0.8 V at 600 °C.

The high operating temperature of a MCFC system also provides for greater fuel flexibility; a variety of hydrocarbon fuels (natural gas, alcohols, landfill gas, syn gas from petroleum coke, coal and biomass, etc.) can be reformed to generate hydrogen for the fuel cell. The CO from biomass and coal gasification product gas and reformed hydrocarbons is not used directly as a fuel but when mixed with water vapor can produce additional hydrogen via the water-gas shift reaction. Oxygen or air is used as the oxidant. An attractive design incorporates an internal fuel reformer within the fuel cell eliminating the need for a separate fuel processor.

A higher operating temperature also means that less expensive materials can be used for the electrocatalysts in the electrodes; Pt is not required and Ni is used as the catalyst. The Ni in the cathode becomes oxidized and lithiated (from contact with the electrolyte) during initial operation of a MCFC so that the active material is Li-doped NiO. Unfortunately, NiO is soluble in molten carbonates leading to the possible dissolution of the cathode and dispersion of metallic nickel in the electrolyte, which can eventually short-circuit the electrodes. This is one of the materials issues that is being investigated to

improve the long-term operability of MCFC systems. Recently, LiCoO_2 and Li_2MnO_3 were found to be alternative materials as cathode.

The anode contains Ni doped with 10% Cr to promote sintering. An external methane reformer is not needed in a MCFC system because the presence of Ni in the anode at MCFC operating temperatures is very effective for internal CH_4 reforming at the anode. Internal methane reforming can increase overall system efficiencies, but can also induce unwanted temperature gradients inside the fuel cell that may cause materials problems. Catalyst poisoning is also an issue if the sulfur content of the reagent gases is greater than 10 ppm, similar to all Ni-based fuel-reforming systems. Coke formation on the anode from fuel reforming can also be an issue.

5.6. Solid oxide fuel cells (SOFCs)

SOFC systems operate between 900-1000 °C, higher than any other fuel cell system. At these operating temperatures, fuel composition is not an issue because in the presence of enough water vapor and oxygen complete oxidation will be achieved, even in the absence of catalytic materials. High overall system efficiencies are possible with waste heat recovery. The electrolyte material in a SOFC is yttrium (8-10 mol%) stabilized zirconia (YSZ). This material is a solid with a stable cubic structure and very high oxide conductivity at SOFC operating temperatures. The mobile O^{2-} ions migrate from the cathode to the anode where water is produced. The electrochemical reactions occurring in a SOFC system are as follows:

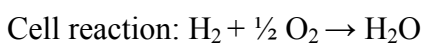
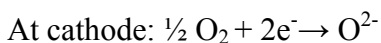
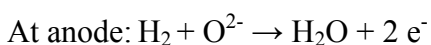

Similar to the MCFC systems, the high operating temperatures of the SOFCs provides fuel flexibility without the need for expensive catalysts in the electrodes. The cathode in a SOFC consists of mixed oxides with a perovskite crystalline structure, typically Sr-doped lanthanum manganate (LaMnO_3). The anode material is a Ni cermet (ceramic and metal composite). It contains metallic Ni for catalytic activity in an YSZ support. The YSZ adds mechanical, thermal, and chemical stability, chemical and thermal compatibility between the anode and the electrolyte is not an issue. Like the MCFC systems, internal

methane steam reforming at the Ni-based anode in the presence of water vapor is possible in SOFC systems. The cells operate at $\sim 1 \text{ A/cm}^2$ at 0.7 V.

Overall, SOFC systems can tolerate impurities because of their high operating temperatures. Sulfur tolerances can be up to two orders of magnitude higher in SOFCs than in other fuel cell systems because of the high operating temperatures. Energy efficient, high temperature sulfur removal methods are used to lower the sulfur content of the gas to less than 10 ppm. At the same time, the high operating temperatures of SOFCs can cause considerable materials issues like material incompatibilities (thermal and chemical) and corrosion.

Significant research and development efforts have gone into technically and cost-effectively addressing materials issues in SOFC systems for commercial applications. This is reflected in the variety of designs for SOFC systems. There are three general types of designs for SOFC systems: tubular, bipolar monolithic, and bipolar planar. The bipolar designs have a bipolar plate that prevents reactant gases in adjacent cells from mixing and provides serial electrical interconnectivity between cells. The single cells are stacked with interconnectors, gas channels, and sealing elements in between. There are two types of tubular designs: seal-less and segmented cell in-series. A single cell in a tubular SOFC consists of a long porous YSZ ceramic tube that acts as a substrate. The cathode, followed by the electrolyte, and finally the anode are deposited on the outer surface of the tube. A portion of the tube is left with a strip of the cathode covered by the interconnector material to make the electrical connection. Individual tubes are arranged in a case and air flows inside the tubes while fuel flows around the outside of the tubes.

Developments in SOFC systems that operate at intermediate temperatures (550-800 °C) are currently receiving considerable attention. Reducing the operating temperature of SOFC systems is being pursued in an attempt to reduce the cost of these systems. Some of the benefits of a reduced operating temperature include: better thermal integration with fuel reformers and sulfur removal systems, reduced material issues such as less thermal stress and more material flexibility, lower heat loss, shorter time to achieve operating temperature, and less corrosion. Capitalizing on the benefits of lower SOFC operating temperatures is an area of continued and future research and development.

References

1. B. Viswanathan and M. Aulice Scibioh, Fuel Cells – Principles and Applications, Universities Press (India) Private Limited, 2006.
2. W. Vielstich, Fuel Cells, Wiley/Interscience, London, 1965.
3. K. Kordesch and G. Simader, Fuel Cells and their Applications, VCH, Weinheim, Germany 1996.
4. L. Carrette, K. A. Friedrich and U. Stimming, Fuel Cells 1 (2001) 1.
5. M. Winter and R. J. Brodd, Chem. Rev. 104 (2004) 4245.
6. W. Vielstich, H. Gasteiger and A. Lamm. (Eds), Hand book of Fuel Cells – Fundamentals, Technology and Applications, Vol. 2: Electrocatalysis, John Wiley & Sons, Ltd, 2003.

Chapter - 10

SUPERCAPACITORS

T. Meialagan

1. Introduction

Supercapacitors have received considerable attention due to their remarkable properties, specifically higher cyclability and power density in comparison with batteries, and higher energy density in comparison with common capacitors. Supercapacitors are electrical storage devices that can deliver a higher amount of energy in a short time. Hybrid-electric and fuel-cell powered vehicles need such a surge of energy to start, more than can be provided by regular batteries. Supercapacitors are also needed in a wide range of electronic and engineering applications, wherever a large, rapid pulse of energy is required. Capacitors which store the energy within the electrochemical double-layer at the electrode/electrolyte interface are known under various names which are trade marks or established colloquial names such as ‘double-layer capacitors’, ‘supercapacitors’, ‘ultracapacitors’, ‘power capacitors’, ‘gold capacitors’ or ‘power cache’. ‘Electrochemical double-layer capacitor’ is the name that describes the fundamental charge storage principle of such capacitors. However, due to the fact that there are in general additional contributions to the capacitance other than double layer effects, these capacitors are termed as electrochemical capacitors (EC).

Electrochemical capacitors have been known since many years. First patents date back to 1957 where a capacitor based on high surface area carbon was described by Becker. Later in 1969 first attempts to market such devices were undertaken by SOHIO. However, only in the nineties electrochemical capacitors became famous in the context of hybrid electric vehicles. A DOE ultracapacitor development program was initiated in 1989, and short terms as well as long term goals were defined for 1998–2003 and after 2003, respectively. The EC was supposed to boost the battery or the fuel cell in the hybrid electric vehicle to provide the necessary power for acceleration, and additionally allow for recuperation of brake energy. Today several companies such as Maxwell Technologies, Siemens Matsushita (now EPCOS), NEC, Panasonic, ELNA, TOKIN, and several others invest in electrochemical capacitor development. The applications

envisaged principally boost the components supporting batteries or replacing batteries primarily in electric vehicles. In addition alternative applications of EC not competing with batteries but with conventional capacitors are coming up and show considerable market potential. Such applications will also be discussed in detail. The reason why electrochemical capacitors were able to raise considerable attention is visualized in Fig. 1 where typical energy storage and conversion devices are presented in the so called ‘**Ragone plot**’ in terms of their specific energy and specific power. Electrochemical capacitors fill in the gap between batteries and conventional capacitors such as electrolytic capacitors or metallized film capacitors. In terms of specific energy as well as in terms of specific power this gap covers several orders of magnitude.

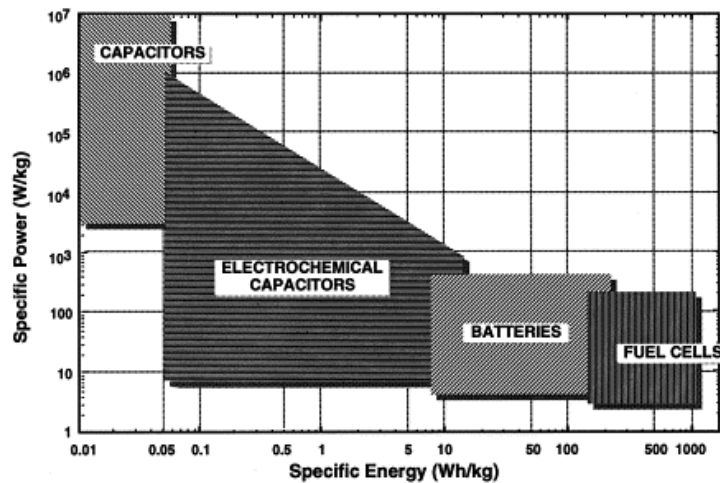

Fig.1. **Sketch** of Ragone plot for various energy storage and conversion devices. The indicated areas are rough guide lines.

2. Principle of operation

In a conventional capacitor (condenser), the charge accumulation is achieved electrostatically by positive and negative charges residing on two interfaces separated by a vacuum or a molecular dielectric (a film of mica, a space of air, or an oxide film). Supercapacitors store the electric energy in an electrochemical double layer formed at the interface between the polarizable electrodes and compensate for the electronic charges at the electrode surface, as shown in Figure 2. This charge distribution layer is called the electric double layer (or electrochemical double layer). Figure 2 presents the principle of an electrochemical capacitor.

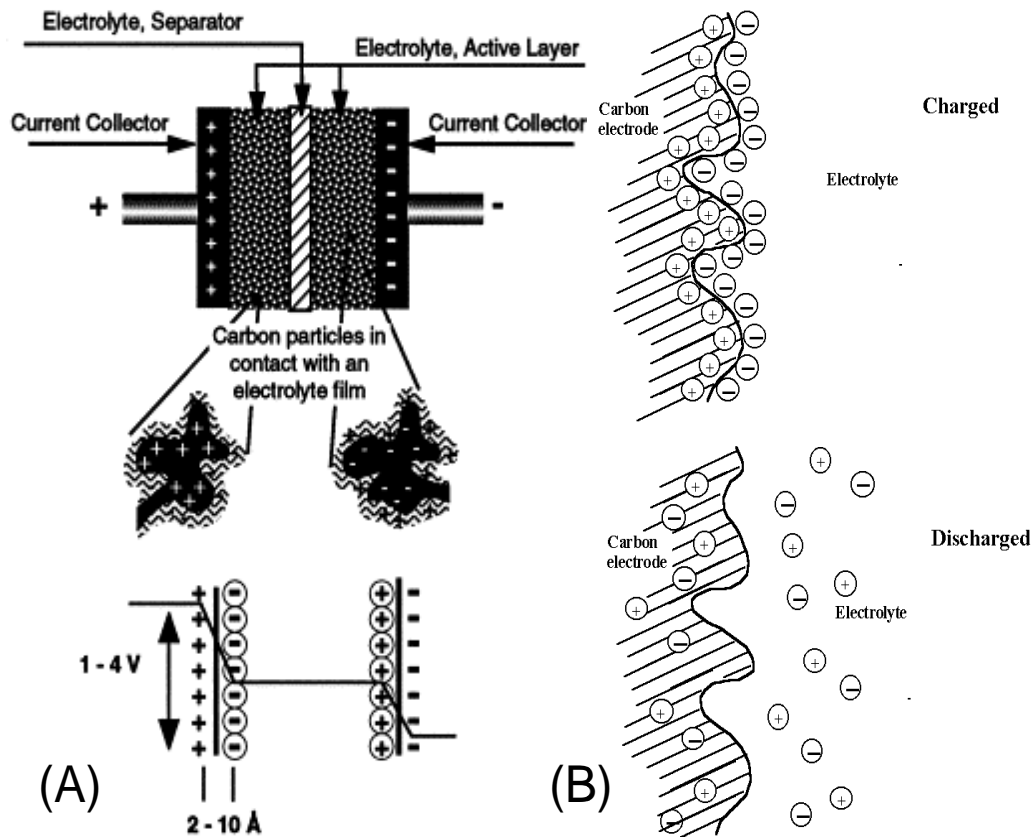

Fig.2. (A) Principle of a single-cell double-layer capacitor and illustration of the potential drop at the electrode/electrolyte interface (B) Function of carbon electrode in an electrochemical capacitor

The thickness of the double layer depends on the concentration of the electrolyte and on the size of the ionic clusters and is typically of the order of $5-10 \text{ \AA}$ for concentrated electrolytes. The capacitance, C , accumulated in the electric double layer formed at the interface between the polarizable electrodes and the electrolyte solution is defined by

$$C = \epsilon / 4 \pi d \delta \int dS$$

Where ϵ is the dielectric constant of the electrolyte, δ is the distance from the electrode interface to the center of the ion, and S is the surface area of the electrode interface. The corresponding electric field in the electrochemical double layer is high and is assumed to be 10^6 V/cm . Compared to conventional capacitors where a total capacitance is typically on the order of pico-farads and microfarads, the capacitance and the energy density stored

in the supercapacitor by the electrochemical double layer is higher. To achieve a higher capacitance the surface area of the electrode is additionally enlarged by using porous electrodes, where an extremely large internal surface area is expected.

There are several techniques for determining the specific capacitance, such as a unit cell test (two electrode system), a half cell test (three electrode system), and an impedance test. The unit cell and half-cell tests are mainly used to determine the specific capacitance of the supercapacitor. The specific capacitances reported in the literature are not consistent, mainly due to the experimental methods used to determine them. For the sake of consistency, it is worth specifying the electrochemical technique for calculating the specific capacitance between the two electrode and three electrode systems. Figure 3 shows the double layer of electrodes used in the two-electrode system (2E), which represents a real double layer supercapacitor device and its equivalent circuit. Figure 3 b shows the double layer of electrodes used in the three-electrode system (3E), which is used in the laboratory cell with a reference electrode and its equivalent circuit. Assuming that the weight of each individual electrode is m , then $C_1=C_2=C$. The capacitance measured for the two electrode system is $C_{2E}=1/2C$. The specific capacitance turns out to be $C_{spec-2E}=C_{2E}/(2m)=1/4(C/m)$. However, for the three electrode system, the double layer capacitance measured is $C_{3E}=C$ and the specific capacitance is $C_{spec-3E}=C_{3E}/(m)=(C/m)$. Thus the relationship between the specific capacitance measured with the two electrode and three electrode techniques is $C_{spec-3E}=4 C_{spec-2E}$

In the double layer at plane electrodes, charge densities of about 16-50 $\mu\text{F}/\text{cm}^2$ are commonly realized. Taking an average value of 30 $\mu\text{F}/\text{cm}^2$, the capacitance of a single Polarizable electrode with a typical surface area of 1000 m^2/g for porous materials leads to a specific capacitance 300 F/g. At 1 V in an aqueous electrolyte, the maximum storage energy, E , is $E=CV_i^2/2=(300 \times 1^2)/2=150 \text{ W-s/g}$, 150kJ/kg or 42 W-h/kg, theoretically. This value is considerably lower than that obtained for available batteries but higher than that for conventional capacitors. It should be mentioned that the above value depends on the double layer capacitance, the specific surface area of the respective electrode material, the wetting behaviour of the pores and the nominal cell voltage.

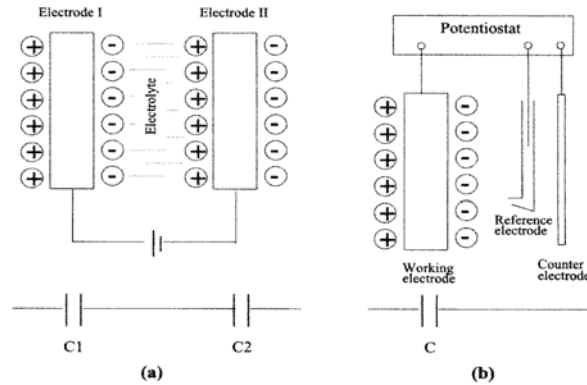

Fig.3. **Electric** double layer and its equivalent circuit in (a) two-dimensional electrode system and (b) three -electrode system

The maximum power density of a supercapacitor is given by $P_{max}=V_i^2/4R$ [V_i = initial voltage, R = equivalent series resistance (ESR)]. Therefore, the key factors determining the power of supercapacitors are the resistivity of the electrode itself, the resistivity of the electrolyte within the porous layer of electrode, and the contact resistance between the electrode and the current collector, as shown in Fig 4.

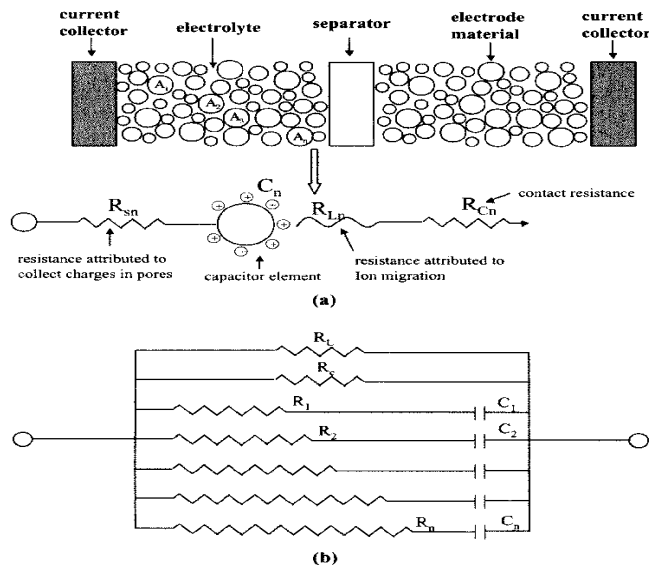

Fig.4. Equivalent circuit of an electrochemical capacitor

In evaluating the performance of supercapacitors, the characterization of their energy density and power density are the most important factors of rating electrochemical power

devices. In addition, from practical and fundamental points of view, there is a question of how the energy density and power density are related to various types of electrochemical power sources, including fuel cells and rechargeable batteries.

3. Differences between a Supercapacitor and Battery

The most important difference between a supercapacitor and a battery is the principle of electrochemical energy storage. Electrochemical energy can be stored in two fundamentally different ways. In a battery, the potentially available chemical energy storage requires Faradaic oxidation and reduction of electrochemically active reagents to release charges that can perform electric work when they flow between two electrodes having different potentials; that is, the charge storage is achieved by electron transfer that produces a redox reaction in the electroactive material according to Faraday's law.

Table 1. Advantages and disadvantages of supercapacitor energy storage devices

Advantages	Disadvantages
(1) Long cycle life , > 100,000 cycles (2) Excellent power density , > 10 ⁶ W/Kg (3) Simple principle and mode of construction (4) Combines state of charge indication (5) Can be combined with secondary battery for hybrid applications (electric vehicles)	(1) Limited energy density (2) Poor volume energy density (3) Low working voltage (4) Requires stacking for high potential operation (electric vehicles)

With an electric double-layer capacitor (EDLC), the charge storage process is non-Faradaic; that is, ideally, no electron transfer takes place across the electrode interface and the storage of electric charge and energy is electrostatic. Actual electron charges are accumulated on the electrode surface with lateral repulsion and involvement of redox chemical changes. Table 1 summarizes the perceived advantages and disadvantages of such EDLC energy storage. Because the charging and discharging of such EDLCs involve no chemical phase and composition changes, such capacitors have a high degree of cyclability on the order of 10⁶ times and a high specific power density , although the specific energy density is rather small. However in some cases of the supercapacitor based on pseudocapacitance (redox type of supercapacitor), the essential process is

Faradaic; that is the charge storage is achieved by an electron transfer that produces a redox reaction (Faradaic reaction) in the electroactive materials according to Faraday's law. The supercapacitors based on pseudocapacitance have higher specific capacitance than the EDLCs, due to the redox reaction as in a battery, although the redox reaction gives rise to high internal resistance in supercapacitors, resulting in a decrease in specific power density. The typical electrodes of supercapacitors based on pseudocapacitance are metal oxides (i.e., RuO_2 , IrO_2 , Co_3O_4) and conducting polymers (i.e., Polypyrrole, polyaniline, Poly thiophene).

Table 2. Overall comparison of supercapacitor and battery characteristics

Item	Supercapacitor	Battery
Slope of charge and discharge curve	Declining slope	Constant slope
Intrinsic stage of charge indication	Good	Bad
Energy density	Poor	Good
Power density	Good	Poor
Cyclability and cycle life	Excellent	Bad
Origin of internal IR	High area matrix + electrolyte	Active electrode materials + electrolyte
Life time	Long	Poor
Cell stacking by bipolar system	Possible	Impossible

A supercapacitor requires two equivalent electrodes, one of which is charged negatively with respect to the other, the charge storage and separation being electrostatic. At each electrode, the charge storage and separation are established across the electrode interface. Usually, the electrodes of supercapacitors have high surface area and porous matrices. However, batteries have bipolar electrode configuration for high voltage series combinations.

For a battery, the maximum Gibbs energy is the product of charge Q and the difference of potential, ΔE , between the Nernstian reversible potentials of the two electrodes, that is, $G = Q \cdot \Delta E$. In the capacitor case, for a given charge Q , G is $1/2 QV$. For a given electrode potential difference, $\Delta E = V$, it is evident that the energy stored by a two-electrode cell accommodating a given Faradaic charge Q at voltage $\Delta E = V$, is twice that stored in a capacitor charged with the same Q at the same voltage. In the process of charging, a pure electric double layer capacitor, every additional element of charge has to do electrical work (Gibbs energy) against the charge density already accumulated on the electrodes, progressively increasing the interelectrode potential difference.

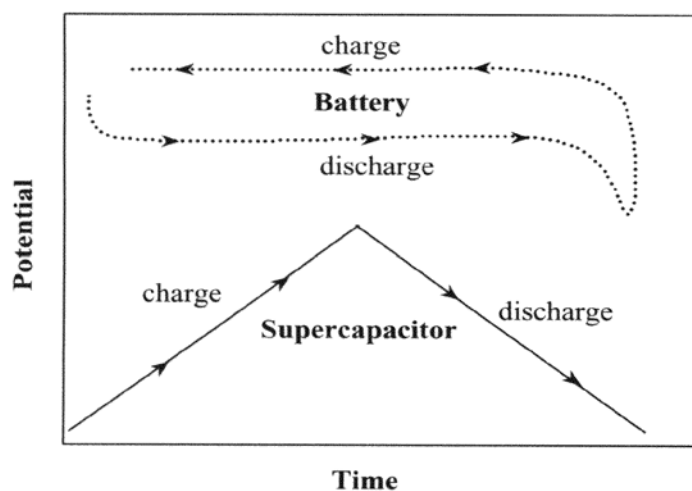

Fig.5. Difference in discharge and recharge relationships for a supercapacitor and a battery

In a battery cell being charged, a thermodynamic potential (ideally) exists independent of the extent of charge Q added, as long as two components (reduced and oxidized forms) of the electroactive material remain existing together. Thus, the potential difference (electromotive force) of the battery cell is ideally constant throughout the discharge or recharge half cycles, so that $G = Q \cdot \Delta E$ rather than $Q \cdot 1/2 \Delta E$ (or $1/2 V$). This difference can be illustrated by the discharge curves shown schematically in Fig. 5, where the voltage in the capacitor declines linearly with the extent of charge, while that for an ideal battery it remains constant as long as two phases remain in equilibrium. The decline in the supercapacitor voltage arises formally since $C = Q/V$ or $V = Q/C$; therefore,

$dV/dQ=1/C$. The ideal battery cell voltages on discharge and recharge, as a function of state of charge, are shown as parallel lines of zero slope in Fig. 5. In the slope of the discharge and recharge lines for the supercapacitor in Fig. 5, there is significant IR drop, depending on the discharging and recharging rates. An overall comparison of electrochemical capacitor and battery characteristics is given in Table 2.

4. Componentets of a Supercapacitor

A. Electrolyte

The electrolyte can be of solid state, organic or aqueous type. Organic electrolytes have a very high dissociation voltage of around 4 V where as aqueous electrolytes (KOH or H_2SO_4) has a dissociation voltage of around 1 V. Thus for getting an output of 12 V, using aqueous electrolyte one would require 12 unit cells where as with organic electrolyte one would require 3 unit cells. This clearly shows that for high voltage requirement one should opt for organic electrolyte. There is added requirement using organic electrolyte, as ions of organic electrolyte are larger, they require large pore size of electrode material.

B. Separator

The type of separator depends upon the type of electrolyte used. If the electrolyte is organic then polymer or paper separator are used. If the electrolyte is aqueous then ceramic separators are used.

C. Electrode

As the energy storage capacity is directly proportional to the surface area of the electrode, electrochemical inert material with high surface area are used. The common electrode materials are metal oxides, Nanoporous carbon and graphite. Carbon based electrode can be made of activated carbon, carbon fibers, carbon black, active carbon, carbon gel, skeleton carbon or mesocarbon. Carbon electrode has very high surface area (as high as $3000\text{ m}^2/\text{gm}$). Recent work has explored the potential of carbon nanotubes as electrode material.

5. Electrode materials for supercapacitors

5.1. Metal oxides:

The concept and use of metal oxide as an electrode material in electrochemical capacitors was introduced by Trassatti and Buzzanca based on ruthenium dioxide (RuO_2) as a new interesting electrode material. Some other oxides, such as, IrO_2 , Co_3O_4 , MoO_3 , WO_3 and TiO_2 , as electrode materials in electrochemical capacitors have been discovered

The cyclic voltammogram of the metal oxide electrodes has almost rectangular shape and exhibits good capacitor behaviour. However, the shape of the cyclic voltammogram is not a consequence of pure double-layer charging, but a consequence of the redox reactions occurring in the metallic oxide, giving rise to the redox pseudo capacitance.

A very high specific capacitance of up to 750 F/g was reported for RuO_2 prepared at relatively low temperatures. Conducting metal oxides such as RuO_2 or IrO_2 were the favored electrode materials in early electrochemical capacitors used for space or military applications. The high specific capacitance in combination with the low resistance resulted in very high specific power. An energy density of 8.3 W-h/kg and a power density of 30 kW/kg were achieved in a prototype 25 –V electrochemical capacitor but only with $\text{RuO}_2 \cdot x \text{H}_2\text{O}$ material and electrolyte. These capacitors however turned out to be too expensive.

A rough calculation of the capacitor cost showed that 90 % of the cost resides in the electrode material. In addition, these capacitor materials are only suitable for aqueous electrolytes, thus limiting the nominal cell voltage to 1 V. several studies have attempted to take advantage of the material properties of such metal oxides at a reduced cost. The dilution of the costly noble metal by the formation of perovskites was investigated by Guthier et al. Other forms of metal compounds such as nitrides were investigated by Liu et al. However, these materials are not yet commercially available in the electrochemical capacitor market.

5.2. Conducting polymers

The discovery of conducting polymers has given rise to a rapidly developing field of electrochemical polymer science. Conducting polymers, such as polyacetylene, polyaniline, polypyrrole, have been suggested by several authors for electrochemical capacitors. The conducting polymers have fairly high electronic conductivities, typically of magnitudes of 1-100 S/cm. The electrochemical processes of conducting polymers are electrochemical redox reactions associated with sequential Lewis acid or Lewis base

production steps so that the polymer molecules are converted to multiply charged structure through electrochemical Lewis-type reactions involving electron withdrawal or electron donation. Therefore, the pseudo capacitance by Faradaic redox processes in conducting polymer based electrochemical capacitors is dominant, although about 2-5 % of double-layer capacitance is included in the total specific capacitance

Such polymer electrode materials are cheaper than RuO_2 or IrO_2 and can generate comparably large specific capacitance. However, the polymer electrode materials do not have the long term stability and cycle life during cycling, which may be a fatal problem in applications. Swelling and shrinking of electro-active conducting polymers is well known and may lead to degradation during cycling. Therefore, these electro active conducting polymers are also far from being commercially used in electrochemical capacitors.

5.3. Carbon

Carbon materials for electrochemical energy devices, such as secondary batteries, fuel cells and supercapacitors, have been extensively studied. However, each type of electrochemical energy device requires different physical properties and morphology. For supercapacitors, the carbon material for the EDLC type must have (i) high specific surface area, (ii) good intra and inter-particle conductivity in porous matrices, (iii) good electrolyte accessibility to intrapore surface area, and (iv) the available electrode production technologies. Carbons for supercapacitors are available with a specific surface area of up to $2500 \text{ m}^2/\text{g}$ as powders, woven cloths, felts or fibers. The surface conditioning of these carbon materials for supercapacitor fabrication is of substantial importance for achieving the best performance, such as good specific surface area, conductivity, and minimum self discharge rates.

5.4 Activated carbon

Carbons with high specific surface area have many oxygen functional groups, such as ketone, phenolic, carbonyl, carboxylic, hydroquinoid, and lactone groups, introduced during the activation procedure for enlarging the surface area. These oxygen functional groups on activated carbons or activated carbon fibers give rise to one kind of electrochemical reactivity, oxidation or reduction. Oxidation or reduction of the redox functional groups shows pseudocapacitance, which amounts to about 5-10 % of the total

realizable capacitance. However, the various surface functionalities in activated carbons are one of the factors that increase the internal resistance (equivalent series resistance; ESR) due to the redox reaction. Activated carbons are cheaper than metal oxides and conducting polymers and they have larger specific surface than the others. Activated carbon based supercapacitors have been commercialized for small memory backup devices. However, activated carbons show lower conductivity than metal oxides and conducting polymers, resulting in a large ESR, which gives smaller power density.

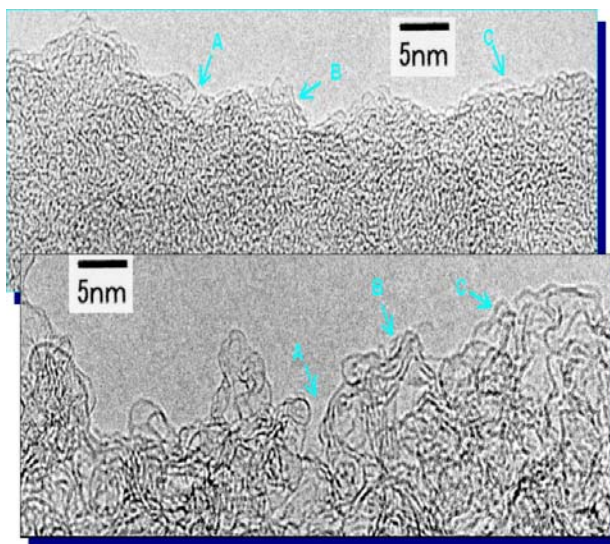

Fig.6. Pores before and after activation of carbon as observed by TEM

In addition, the observed specific capacitances of the carbon based supercapacitors are about one-fourth the theoretical capacitance in spite of their high specific surface area, which is attributed to the existence of micropores. This is a weak point of active carbons as electrode materials in supercapacitors with high energy density and power density. Activated carbons are famous for their surface areas of 1000 to 3000m²/g. Fig. 6 shows an observation with a TEM (Transmission Electron Microscope) magnified to 2,000,000 times using phase-contrast method. In the upper photo, each black line identifies a graphite layer with the space between two adjacent lines measuring 0.34 nano-meters. After activation as shown in the lower picture, the space has swollen to make the surface area for double layer.

6. Carbon nanotube (CNT) based supercapacitors

During the last decade, the application of activated carbons as the electrode materials in supercapacitors has been intensively investigated because of their high specific surface area and relatively low cost. Since the specific capacitance of a supercapacitor is proportional to the specific surface area, the effective surface area of the electrode materials is important. Theoretically, the higher the specific surface area of an activated carbon, the higher the specific capacitance should be. Unfortunately, the theoretical capacitance of the activated carbons is not in good agreement with the observed value, because of significant part of the surface area remains in the micropores ($< 20\text{\AA}^0$), which are not accessible to the electrolyte ions. Therefore, the pore size distribution together with the surface area is important for the determination of the electric double layer capacitance. From this point of view, carbon nanotubes have several advantages as the electrode materials for supercapacitors. CNTs have a narrow distribution of mesopores sizes, highly accessible surface area, low resistivity, and high stability, attracting great interest world wide for building supercapacitors.

6.1 Carbon nanotube electrodes

In recent years, high power supercapacitors based on the CNT electrodes using aqueous electrolytes have been reported. , Niu et al .have reported that supercapacitor electrodes, prepared from catalytically grown multiwalled CNTs whose surface area is $430\text{ m}^2/\text{g}$, show a maximum specific capacitance of 113 F/g and a power density of 8 kW/kg at an energy density of 0.56 Wh/kg in a solution of $38\text{ wt. \% H}_2\text{SO}_4$ used as the electrolyte. Ma et al., also used CNT electrodes based on CNTs that were prepared as in previous publications but with a binder introduced to form solid electrodes. They obtained specific capacitances of $15\pm 25\text{ F/g}$ in a solution of $38\text{ wt. \% H}_2\text{SO}_4$. Frackowiak et al., investigated the electrochemical characteristics of supercapacitors built from MWNT electrodes with the specific surface area of $430\text{ m}^2/\text{g}$, in 1 M KOH aqueous solution as well as the correlation of micro texture with the elemental composition of the materials. They argued that the presence of mesopores due to the central canal and or the entanglement of CNTs are the reasons for the easy access of the ions to the electrode/electrolyte interface for charging the electric double layer. They detected pure electrostatic attraction of ions as well as quick Faradaic reactions upon varying surface

functionality, which was induced during acidic oxidation. The values of specific capacitance varied from 4 to 135 F/g, depending on the type of nanotubes and their post treatments (acidic oxidation).

Zhang et al. studied supercapacitors using MWNT electrodes in organic electrolyte systems. The MWNT electrodes exhibited a specific surface area of 100 m²/g and a measured specific capacitance of up to 18.2 F/g (16.6 F/cm³) with 1M LiClO₄ in a mixture of ethylene carbonate and propylene carbonate (1:1 volume ratio) as the organic electrolyte solution. They found that the specific capacitance was lower than that reported by other groups using aqueous electrolytes, due to the low specific surface area of the MWNT electrode and the organic electrolyte solution used. However, the energy density of the supercapacitor can reach 20 Wh/Kg at 10 mA discharge current density, depending on the organic electrolyte solution system. The relative volume of mesopores and macropores of the used electrode exceeds 92 % and micropores are nearly negligible. In the case of the organic electrolytes, because of their large molecular structures, only mesopores and macropores are accessible and are larger than those of activated carbons for supercapacitors.

Since the sizes of hydrated ions are in the range of 6±7.6 Å the minimum effective pore size should be greater than 15 Å. It is known that, in general, pore sizes in the range of 30±50 Å are required to maximize the capacitance in the electrical double-layer capacitor. In macropores (> 50 Å) the hydrated ions are usually loosely bound to the surface layer and do not particularly contribute to the capacitance.

Fig.7a shows the specific capacitances of the heat-treated electrodes at various temperatures as a function of the charging time. Capacitances increase abruptly and reach about 80 % of the maximum capacitance during the initial 10 min, regardless of the heat-treatment temperatures. The capacitances gradually increase further and saturate to the maximum values at long charging times. Persistent increase of the capacitance over a long time is generally observed from the porous electrodes and is attributed to the existence of various forms of pores and pore diameters in the electrode. The saturated capacitance increases with increasing heat-treatment temperatures and saturates to 180 F/g at 1000 °C. High-temperature annealing of CNT electrodes improves the quality of

the sample not only by increasing the specific surface area but also by redistributing the CNT pore sizes to the smaller values near $30\pm 50 \text{ \AA}$.

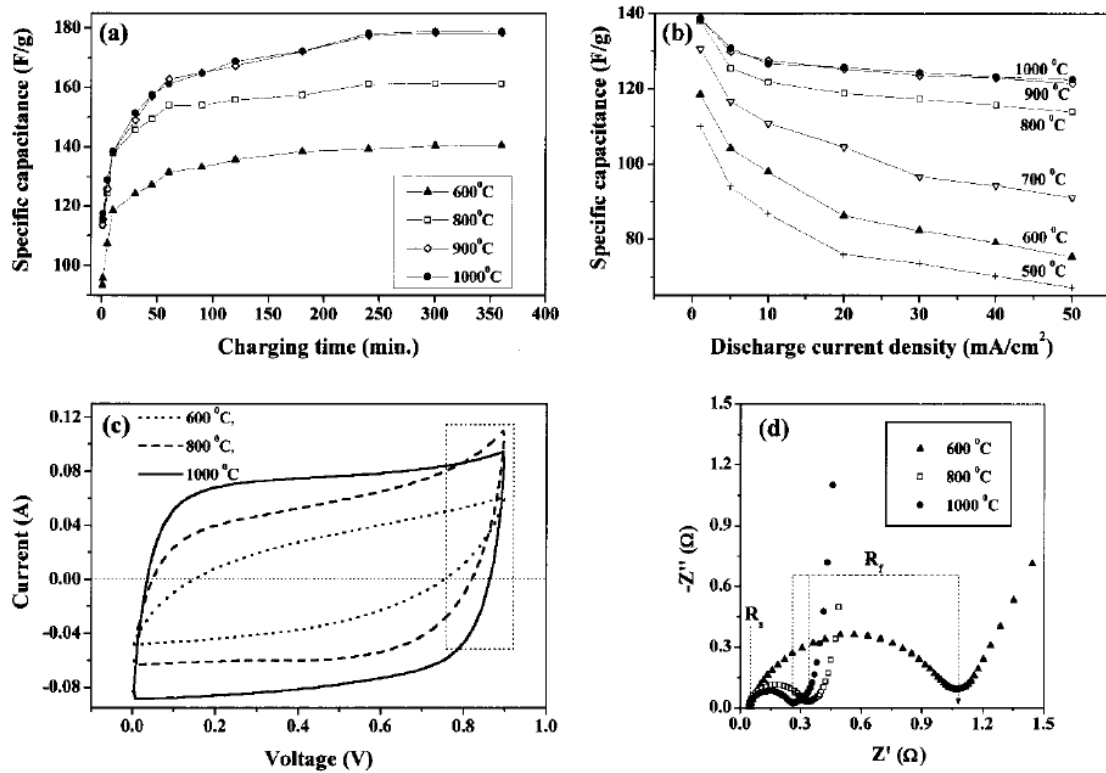

Fig.7. Electrochemical properties of the supercapacitor using the CNT electrodes. a) The specific capacitances of the heat-treated electrodes at various temperatures as a function of the charging time at a charging voltage of 0.9 V, where the capacitance was measured at a discharging current of 1 mA/cm². b) The specific capacitances of the heat-treated electrodes at various temperatures as a function of the discharging current density at a charging voltage of 0.9 V for 10 min. c) The cyclic voltammetric (CV) behaviors (sweep rate, 100 mV/s) for the CNT electrodes at various heat-treatment temperatures. d) The complex-plane impedance plots for the CNT electrodes for various heat-treatment temperatures at an ac-voltage amplitude of 5 mV, Z'' : imaginary impedance, Z' : real impedance.

Fig.7b shows the specific capacitance as a function of discharge current density at various heat-treatment temperatures, where the data were taken from the samples charged at 0.9 V for 10 min. At low temperatures below 700 °C, the specific capacitance at a discharging current density of 50 mA/m² drops by about 30 % of the capacitance at 1 mA/cm². However, at high annealing temperature (1000 °C), the capacitance drops only by about 10 % even for large discharging current density. The existence of the long flat region in the discharging current density is of practical importance for applications of

supercapacitors to various realistic devices. Large capacitance drops at low annealing temperatures are caused by the internal resistance of the CNT electrode. Figure 7c shows the cyclic voltammetric (CV) behavior with a sweep rate of 100 mV/s at various temperatures. The inner integrated area (current x voltage) is the power density, which increases with increasing heat-treatment temperatures. This power density will be larger if the ESR, the slope of V/I (indicated by the dotted box in Fig. 7c), is smaller. The CV curve at 1000 °C is close to the ideally rectangular shape, indicating the smallest ESR in the CNT electrode. The magnitude of the ESR can be more clearly shown in the complex-plane impedance plots, as shown in Fig. 7d. The electrolyte resistance, R_s , is constant and varies with the electrolyte. The sum of the resistance of the electrode itself and the contact resistance between the electrode and the current collector is represented by R_f . The electrolyte resistance and the contact resistance are identical in all samples. Therefore, a decrease of the R_f indicates a decrease of the CNT-electrode resistance. The CNT electrode resistance decreases rapidly at high temperatures of 800 and 1000 °C. The R_f is closely related to the power density, as evidenced by comparing two curves in Figures 7c and 7d. The ideally polarizable capacitance will give rise to a straight line along the imaginary axis (Z^2). In real capacitors with a series resistance, this line has a finite slope, representing the diffusive resistivity of the electrolyte within the pore of the electrode. With increasing heat-treatment temperature, the diffusive line comes closer to an ideally straight line, as shown in Figure 7d. The formation of abundant pore diameters of 30 ± 50 Å with increasing temperature may also enhance the diffusivity of the hydrated ions in the pore, which in turn reduces the CNT-electrode resistance and increase the capacitance.

6.2. Carbon nanotube-composite electrodes

To increase the capacitance of nanotubes, it is possible to increase the electrode surface area or to increase the pseudo capacitance effects obtained by addition of special oxides or electrically conducting polymers (ECP) like polypyrrole (PPy). The ECPs have the advantage of lower costs compared to oxides. Another advantage is that the pseudo capacitance effects of ECPs are quite stable. The modification of carbon material by a specific additive providing quick pseudo-capacitance redox reactions is another way to enhance capacitance. This is possible with metal oxides, but in this case the addition of

ECP is used. ECP itself has a capacitance of about 90 F/g. Pseudo capacitance effects of ECP are relatively stable. If one can coat a nanotube with, for instance, polypyrrole the profit of the good electronic conducting properties and keep the advantage of ionic conductivity in the opened mesoporous network of the nanotube. These are perfect conditions for a supercapacitor.

Frackowiak *et al.* took three types of electrically conducting polymers (ECPs), i.e. polyaniline (PANI), polypyrrole (PPy) and poly-(3,4-ethylenedioxythiophene) (PEDOT) have been tested as supercapacitor electrode materials in the form of composites with multiwalled carbon nanotubes (CNTs).

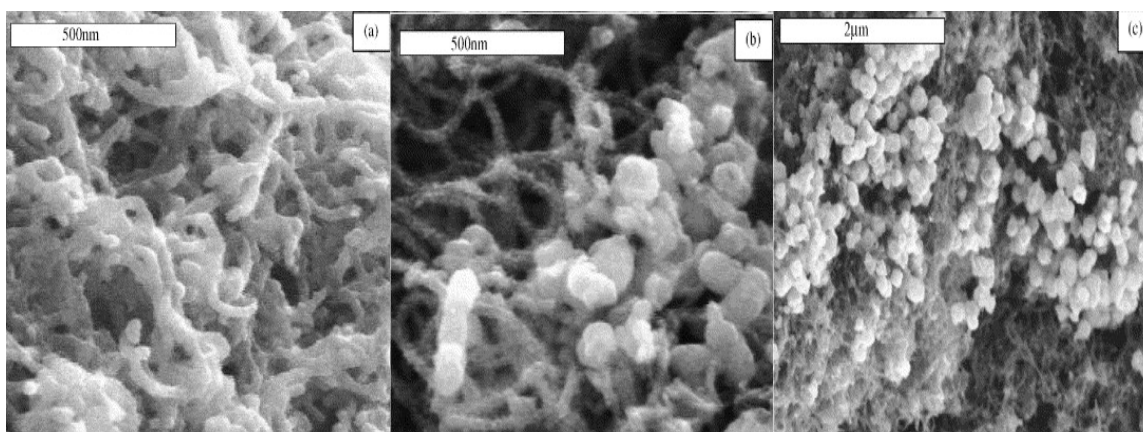

Fig. 8. SEM of composites from CNTs with PANI (a), PPy (b) and PEDOT (c) prepared by chemical polymerization

In the case of polyaniline (Fig.8a), the nanocomposite is homogenous and CNTs are equally coated by conducting polymer. The average diameter of the PANI coated nanotubes is up to 80 nm. By contrast, for the PPy composite (Fig. 8b) a globular structure and irregular deposits are observed. In the case of the PEDOT/CNTs composite a strong tendency for polymerization on the polymer itself appears.

The results of capacitance measurements on the different combinations of ECPs composites working in their optimal potential range were also tested and are given in Table 3. It can be concluded that the nanotubes with electrochemically deposited polypyrrole gave a higher values of capacitance than the untreated samples. Electrochemical behaviour of PANI dictates its choice as a positive electrode because of

a rapid loss of conductivity in the negative potential range. On the other hand PPy as well as PEDOT could serve as both electrodes (+) and (-) taking into account a suitable voltage range. Higher performance is observed for a PANI/CNTs (+)//PPy/CNTs (-) capacitor which supplies 320 F g^{-1} . An additional increase of the supercapacitor power and energy density through enhancement of the operating voltage can be easily realized by application of activated carbon as a negative electrode. Instead of CNTs, acetylene black could be also used as carbon additive in such composites; however, nanotubes act as a more convenient backbone and allow a better dispersion of the conducting polymer.

Table 3. Combination of different materials for positive and negative electrodes of supercapacitor

Positive (+)	Negative (-)	C (F g^{-1})	U (V)
PANI	PPy	320	0.6
PANI	PEDOT	160	0.8
PANI	Carbon (PX21)	330	1.0
PPy	Carbon (PX21)	220	1.0
PEDOT	Carbon (PX21)	120	1.8

Electrolyte: $1 \text{ mol L}^{-1} \text{ H}_2\text{SO}_4$; ECPs/CNTs composites (80 wt%/20 wt%)

7. Future of energy storage devices using carbon nanotubes

One of the important challenges is to realize optimal energy conversion, Storage and distribution. These are clearly related to the development of several key technologies such as transport, communications, and electronics. The environmental problems and economic aspects related to the development and use of electrochemical energy storage devices are of significance.

In particular, the new application and development of supercapacitors and Li-ion batteries are directly related to technologies for manufacturing electric vehicles (EVs) and hybrid

electric vehicles (HEVs). The supercapacitor in EVs or HEVs will serve as short- time energy storage device with high power density. It will also reduce the size of the primary source (batteries (EVs), internal combustion engine (HEVs), fuel cell) and keep them running at an optimized operation point. High power supercapacitors for EVs or HEVs will require a high working voltage of 100 to 300 V with low resistance and large energy density by series and parallel connections of elemental capacitors, in which very uniform performance of each supercapacitor unit is essential.

Another prospect is the micro-supercapacitor and micro battery for use in micro- (or nano)-electromechanical systems (MEMS or NEMS). In recent years MEMS (or NEMS) technologies have attracted attention worldwide for their potential applications that include medical communication equipment, sensors and actuators. Many technical problems have to be solved for the successful development of these types of micro-devices. One of the most important challenges is to develop an optimal micro-power source for operating these devices. The MEMS (or NEMS) has, in many cases, low current and power requirements. This may be realized by using Micro-supercapacitors and micro batteries as power sources for these devices.

References

1. B. E. Conway, *Electrochemical Supercapacitors*, Kluwer Academic Publishers, Norwell, MA (1999)
2. Y. H. Lee, K. H. An, J. Y. Lee, and S. C. Lim, 'Carbon nanotube-based supercapacitors', *Encyclopedia of Nanoscience and Nanotechnology*, edited by H. S. Nalwa, American Scientific Publishers, 625 (2004)
3. Y. H. Lee, K. H. An, S. C. Lim, W. S. Kim, H. J. Jeong, C. H. Doh, and S. I. Moon, "Applications of carbon nanotubes to energy storage devices", *New Diamond & Frontier Carbon Technology* **12(4)**, 209 (2002).
4. P. M. Wilde, T. J. Guther, R. Oesten, and J. Garche, *J. Electroanal. Chem.*, **461**, 154 (1999).
5. T.-C. Liu, W. G. Pell, B. E. Conway, and S. L. Robeson, *J. Electrochem. Soc.* **145**, 1882 (1998).
6. E. Frackowiak, K. Jurewicz, S. Delpeux, F. Beguin, *J. Power Sources* **97**, 822 (2001).
7. E. Frackowiak, V. Khomenko, K. Jurewicz, K. Lota and F. Béguin,

- J. Power Sources* **153**, 413 (2006).
8. B. Zhang, J. Liang, C. L. Xu, B. Q. Wei, D. B. Ruan and D. H. Wu, *Mater. Lett.*, 51 539 (2001).
9. C. Niu, E. K. Sichel, R. Hoch, D. Moy and H. Tennent, *Appl. Phys. Lett.*, **70**, 1480 (1997).
10. R. Z. Ma, J. Liang, B. Q. Wei, B. Zhang, C. L. Xu and D. H. Wu, *J. Power Sources.*, **84**, 126 (1999).
11. K. H. An, W. S. Kim, K. K. Jeon, Y. S. Park, J. M. Moon, S. C. Lim, D. J. Bae, and Y. H. Lee, *J. Electrochem. Soc.*, **149(8)**, A1058 (2002).
12. K. H. An, W. S. Kim, Y. C. Park, D. J. Bae, Y. C. Choi, S. M. Lee, D. C. Chung, S. C. Lim, and Y. H. Lee, *Adv. Mater.*, 13(7), 497 (2001).

Chapter - 11

PHOTOVOLTAICS

M. Sathish

1. Introduction

Photovoltaic devices use semiconducting materials to convert sunlight directly into electricity. It was first observed in 1839 by the French scientist Becquerel who detected that when light was directed onto one side of a simple battery cell, the current generated could be increased. In the late 1950s, the space programme provided the impetus for the development of crystalline silicon solar cells. The first commercial production of photovoltaic modules for terrestrial applications began in 1953 with the introduction of automated photovoltaic production plants.

Conventional photovoltaic cells are made of crystalline silicon that has atoms arranged in a three dimensional array, making it an efficient semiconductor. While this material is most commonly used in converting light energy into electricity, it has associated drawbacks, like high material costs for silicon, costly processes for purifying silicon and manufacturing wafer, additional processes for assembly of modules, and bulky and rigid nature of the photovoltaic panels.

2. How does this device work?

Photovoltaic cells convert sunlight directly into electricity without creating any air or water pollution. Photovoltaic cells are made of at least two layers of semiconductor material. One layer has a positive charge, the other negative. When light enters the cell, some of the photons from the light are absorbed by the semiconductor atoms, freeing electrons from the cell's negative layer to flow through an external circuit and back into the positive layer. This flow of electrons produces electric current. To increase their utility, many number of individual photovoltaic cells are interconnected together in a sealed, weatherproof package called a module (Figure 1). When two modules are wired together in series, their voltage is doubled while the current stays constant. When two modules are wired in parallel, their current is doubled while the voltage stays constant. To achieve the desired voltage and current, modules are wired in series and parallel into

what is called a PV array. The flexibility of the modular PV system allows designers to create solar power systems that can meet a wide variety of electrical needs, no matter how large or small.

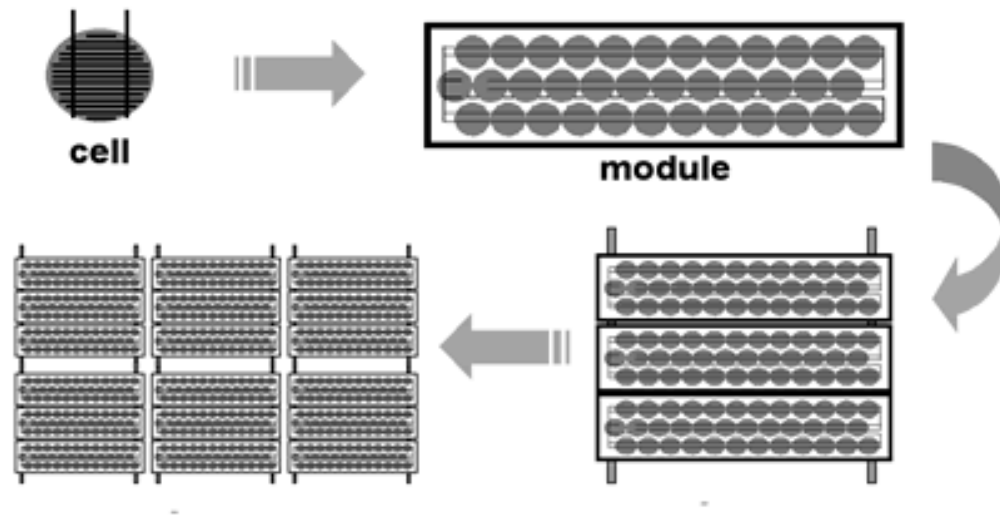

Fig.1. Photovoltaic cells, modules, panels and arrays

Photovoltaic modules are usually installed on special ground or pole mounting structures. Modules may be mounted on rooftops provided that proper building and safety precautions are observed. For more output, modules are sometimes installed on a tracker - a mounting structure that moves to continually face the sun throughout the day.

The performance of photovoltaic modules and arrays are generally rated according to their maximum DC power output under Standard Test Conditions (STC). Standard Test Conditions are defined by a module operating temperature of 250 °C, and incident solar irradiance level of 1000 W/m² and under Air Mass 1.5 spectral distribution. Since these conditions are not always typical of how PV modules and arrays operate in the field, actual performance is usually 85 to 90 % of the STC rating.

3. Fabrication of photovoltaic cells

3.1. Silicon based photovoltaic cells

The process of fabricating conventional single- and polycrystalline silicon photovoltaic cells begins with very pure semiconductor-grade polysilicon - a material processed from quartz and used extensively throughout the electronics industry. The polysilicon is then

heated to melting temperature, and trace amounts of boron are added to the melt to create a p-type semiconductor material. Next, an ingot, or block of silicon is formed, commonly using one of two methods: (1) by growing a pure crystalline silicon ingot from a seed crystal drawn from the molten polysilicon or (2) by casting the molten polysilicon in a block, creating a polycrystalline silicon material. Individual wafers are then sliced from the ingots using wire saws and then subjected to a surface etching process. After the wafers are cleaned, they are placed in a phosphorus diffusion furnace, creating a thin N-type semiconductor layer around the entire outer surface of the cell. Next, an anti-reflective coating is applied to the top surface of the cell, and electrical contacts are imprinted on the top (negative) surface of the cell. An aluminized conductive material is deposited on the back (positive) surface of each cell, restoring the p-type properties of the back surface by displacing the diffused phosphorus layer. Each cell is then electrically tested, sorted based on current output, and electrically connected to other cells to form cell circuits for assembly in PV modules.

3.2 Band gap energies of semiconductors

When light shines on crystalline silicon, electrons within the crystal lattice may be freed. But not all photons, only photons with a certain level of energy can free electrons in the semiconductor material from their atomic bonds to produce an electric current. This level of energy, known as the "band gap energy," is the amount of energy required to dislodge an electron from its covalent bond and allow it to become part of an electrical circuit. To free an electron, the energy of a photon must be at least as great as the band gap energy. However, photons with more energy than the band gap energy will expend that extra amount as heat when freeing electrons. So, it is important for a photovoltaic cell to be "tuned" through slight modifications to the silicon's molecular structure to optimize the photon energy. A key to obtaining an efficient PV cell is to convert as much sunlight as possible into electricity.

Crystalline silicon has band gap energy of 1.1 eV. The band gap energies of other effective photovoltaic semiconductors range from 1.0 to 1.6 eV. In this range, electrons can be freed without creating extra heat. The photon energy of light varies according to the different wavelengths of the light. The entire spectrum of sunlight, from infrared to ultraviolet, covers a range of about 0.5 eV to about 2.9 eV. For example, red light has an

energy of about 1.7 eV, and blue light has an energy of about 2.7 eV. Most PV cells cannot use about 55 % of the energy of sunlight, because this energy is either below the band gap of the material or carries excess energy.

3.3. Doping silicon to create n-Type and p-Type silicon

In a crystalline silicon cell, we need to contact p-type silicon with n-type silicon to create the built-in electrical field. The process of doping, which creates these materials, introduces an atom of another element into the silicon crystal to alter its electrical properties. The dopant, which is the introduced element, has either three or five valence electrons, which is one less or one more than silicon's four.

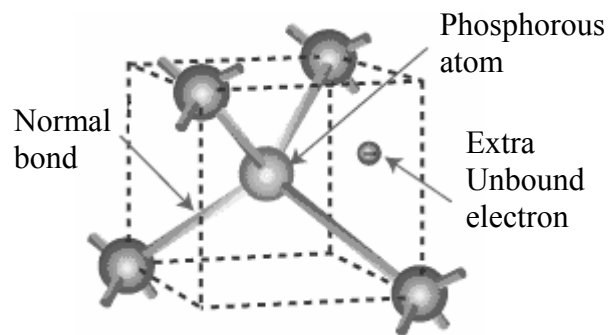

Fig.2. Phosphorus substituted n-type silicon

Phosphorus atoms, which have five valence electrons, are used in doping n-type silicon, because phosphorus provides its fifth free electron. A phosphorus atom occupies the same place in the crystal lattice formerly occupied by the silicon atom it replaces (Figure. 2). Four of its valence electrons take over the bonding responsibilities of the four silicon valence electrons that they replaced. But the fifth valence electron remains free, having no bonding responsibilities. When phosphorus atoms are substituted for silicon in a crystal, many free electrons become available.

The most common method of doping is to coat a layer of silicon material with phosphorus and then heat the surface. This allows the phosphorus atoms to diffuse into the silicon. The temperature is then reduced so the rate of diffusion drops to zero. Other methods of introducing phosphorus into silicon include gaseous diffusion, a liquid dopant spray-on process, and a technique where phosphorus ions are precisely driven into the surface of the silicon.

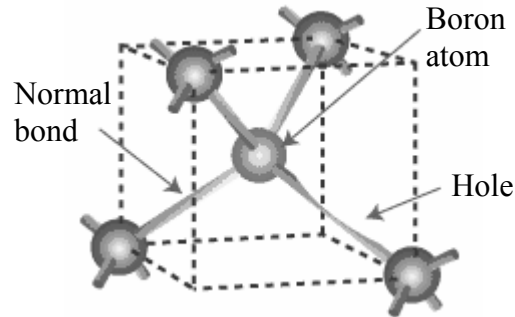

Fig.3. Boron substituted p-type silicon

The n-type silicon doped with phosphorus cannot form an electric field by itself. One also needs p-type silicon. Boron, which has only three valence electrons, is used for doping p-type silicon (Figure 3). Boron is introduced during silicon processing when the silicon is purified for use in photovoltaic devices. When a boron atom takes a position in the crystal lattice formerly occupied by a silicon atom, a bond will be missing an electron. In other words, there is an extra positively charged hole.

3.4. Absorption and Conduction

In a photovoltaic cell, photons are absorbed in the p-layer. And it's very important to "tune" this layer to the properties of incoming photons to absorb as many as possible, and thus, to free up as many electrons as possible. Another challenge is to keep the electrons from meeting up with holes and recombining with them before they can escape from the photovoltaic cell. To do all this, we design the material to free the electrons as close to the junction as possible, so that the electric field can help send the free electrons through the conduction layer (the n-layer) and out into the electrical circuit (Figure 4). By optimizing all these characteristics, one improves the photovoltaic cell's conversion efficiency, which is how much of the light energy is converted into electrical energy by the cell.

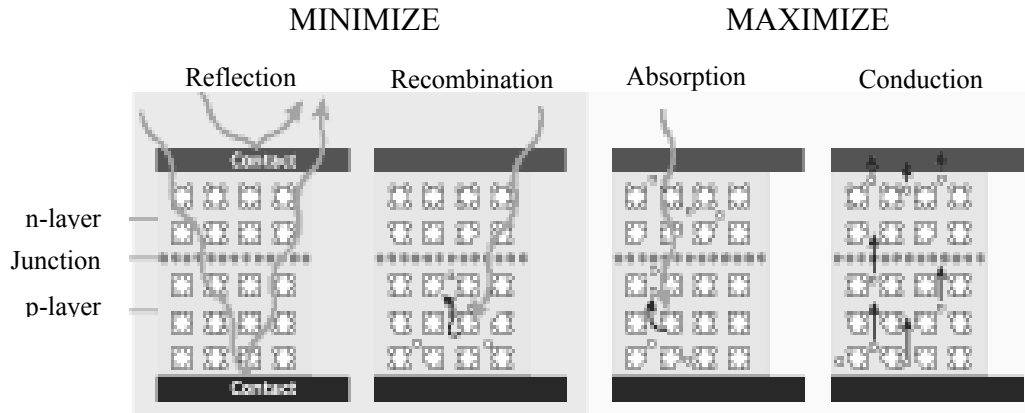

Fig.4. Adsorption and conduction in the photovoltaic systems

3.5. Electrical contacts

Electrical contacts are essential to a photovoltaic cell because they bridge the connection between the semiconductor material and the external electrical load, such as a light bulb. The back contact of a cell, *i.e.*, on the side away from the incoming sunlight *i.e.* is relatively simple. It usually consists of a layer of aluminum or molybdenum metal. But the front contact, on the side facing the sun, *i.e.* is more complicated. When sunlight is shined on the photovoltaic cell, electron current flows all over its surface. If we attach contacts only at the edges of the cell, it will not work well because of the great electrical resistance of the top semiconductor layer. Only a small number of electrons would make it to the contact.

To collect the maximum current, one must place contacts across the entire surface of a photovoltaic cell. This is normally done with a "grid" of metal strips or "fingers." However, placing a large grid, which is opaque, on the top of the cell shades active parts of the cell from the sun. The cell's conversion efficiency is thus significantly reduced. To improve the conversion efficiency, we must minimize these shading effects. Another challenge in cell design is to minimize the electrical resistance losses when applying grid contacts to the solar cell material. These losses are related to the solar cell material's property of opposing the flow of an electric current, which results in heating the material. Therefore, in designing grid contacts, we must balance shading effects against electrical resistance losses. The usual approach is to design grids with many thin, conductive fingers spreading to every part of the cell's surface. The fingers of the grid must be thick

enough to conduct well (with low resistance), but thin enough not to block much of the incoming light. This kind of grid keeps resistance losses low while shading only about 3% to 5% of the cell's surface.

Grids can be expensive to make and can affect the cell's reliability. To make top-surface grids, we can either deposit metallic vapors on a cell through a mask or paint them on via a screen-printing method. Photolithography is the preferred method for the highest quality, but has the greatest cost. This process involves transferring an image via photography, as in modern printing. An alternative to metallic grid contacts is a transparent conducting oxide (TCO) layer such as tin oxide (SnO_2). The advantage of TCOs is that they are nearly invisible to incoming light, and they form a good bridge from the semiconductor material to the external electrical circuit. TCOs are very useful in manufacturing processes involving a glass superstrate, which is the covering on the sun-facing side of a PV module. Some thin-film PV cells, such as amorphous silicon and cadmium telluride, use superstrates. In this process, the TCO is generally deposited as a thin film on the glass superstrate before the semiconducting layers are deposited. The semiconducting layers are then followed by a metallic contact that will actually be the bottom of the cell. The cell is actually constructed "upside down," from the top to the bottom. But the construction technique is not the only thing that determines whether a metallic grid or TCO is best for a certain cell design. The sheet resistance of the semiconductor is also an important consideration. In crystalline silicon, for example, the semiconductor carries electrons well enough to reach a finger of the metallic grid. Because the metal conducts electricity better than a TCO, shading losses are less than losses associated with using a TCO. Amorphous silicon, on the other hand, conducts very poorly in the horizontal direction. Therefore, it benefits from having a TCO over its entire surface.

3.6. Antireflective coating

Since, silicon is a shiny gray material and can act as a mirror, reflecting more than 30% of the light that shines on it. To improve the conversion efficiency of a solar cell, to minimize the amount of light reflected so that the semiconductor material can capture as much light as possible to use in freeing electrons. Two techniques are commonly used to

reduce reflection. The first technique is to coat the top surface with a thin layer of silicon monoxide (SiO). A single layer reduces surface reflection to about 10%, and a second layer can lower the reflection to less than 4%. A second technique is to texture the top surface. Chemical etching creates a pattern of cones and pyramids, which capture light rays that might otherwise to deflect away from the cell. Reflected light is redirected down into the cell, where it has another chance to be absorbed.

4. Photovoltaic module performance ratings

Generally, the performances rating of photovoltaic are expressed in terms of peak watt. The peak watt (W_p) rating is determined by measuring the maximum power of a PV module under laboratory conditions of relatively high light level, favorable air mass, and low cell temperature. But these conditions are not typical in the real world. Therefore, one may uses a different procedure, known as the NOCT (Normal Operating Cell Temperature) rating. In this procedure, the module first equilibrates with a specified ambient temperature so that maximum power is measured at a nominal operating cell temperature. This NOCT rating results in a lower watt value than the peak-watt rating, but it is probably more realistic. Neither of these methods is designed to indicate the performance of a solar module under realistic operating conditions. Another technique, the AMPM Standard, involves considering the whole day rather than "peak" sunshine hours. This standard, which seeks to address the practical user's needs, is based on the description of a standard solar global-average day (or a practical global average) in terms of light levels, ambient temperature, and air mass. Solar arrays are designed to provide specified amounts of electricity under certain conditions. The following factors are usually considered when determining array performance: characterization of solar cell electrical performance, determination of degradation factors related to array design and assembly, conversion of environmental considerations into solar cell operating temperatures, and calculation of array power output capability.

4.1. Power output.

Power available at the power regulator, specified either as peak power or average power produced during one day.

4.2. Energy output.

The energy is expressed as watt-hour or Wh. This indicates the amount of energy produced during a certain period of time. The parameters are output per unit of array area (Wh/m²), output per unit of array mass (Wh/kg), and output per unit of array cost (Wh/\$).

4.3. Conversion efficiency.

This parameter is defined as

$$\frac{\text{Energy output from array}}{\text{Energy input from sun}} \times 100$$

This last parameter is often given as a power efficiency, equal to "power output from array" / "power input from sun" x 100%. Power is typically given in units of watts (W), and energy is typical in units of watt-hours (Wh). To ensure the consistency and quality of photovoltaic systems and increase consumer confidence in system performance, various groups such as the Institute of Electrical and Electronics Engineers (IEEE) and the American Society for Testing and Materials (ASTM) are working on standards and performance criteria for photovoltaic systems.

5. *Reliability of photovoltaic Systems*

Reliability of photovoltaic arrays is an important factor in the cost of systems and in consumers accepting this technology. The photovoltaic cell itself is considered a "solid-state" device with no moving parts, and therefore, it is highly reliable and long-lived. Therefore, reliability of photovoltaic usually focuses not on cells, but on modules and systems. One way to measure reliability is the rate of failure of particular parts. The failure of solar cells mostly involves cell cracking, interconnect failures (resulting in open circuits or short circuits), and increased contact resistance. Module-level failures include glass breakage, electrical insulation breakdown, and various types of encapsulate failures.

Fault-tolerant circuit design involves using various redundant features in the circuit to control the effect of partial failure on overall module yield and array power degradation. Degradation can be controlled by dividing the modules into a number of parallel solar cell networks called branch circuits. This type of design can also improve module losses due to broken cells and other circuit failures. Bypass diodes or other corrective measures can mitigate the effects of local cell hot-spots. Replacement of the entire module is a final

option in dealing with photovoltaic array failures. However, today's component failure rates are low enough that, with multiple-cell interconnects, series/paralleling, and bypass diodes; it is possible to achieve high levels of reliability.

6. Classification of photovoltaic systems

Photovoltaic power systems are generally classified according to their functional and operational requirements, their component configurations, and how the equipment is connected to other power sources and electrical loads. The two principle classifications are grid-connected or utility-interactive systems and stand-alone systems. Photovoltaic systems can be designed to provide DC and/or AC power service, can operate interconnected with or independent of the utility grid, and can be connected with other energy sources and energy storage systems.

6.1. Grid-Connected (Utility-Interactive) PV Systems

Grid-connected or utility-interactive photovoltaic systems are designed to operate in parallel with and interconnected with the electric utility grid. The primary component in grid-connected photovoltaic systems is the inverter, or power conditioning unit (PCU). The PCU converts the DC power produced by the photovoltaic array into AC power consistent with the voltage and power quality requirements of the utility grid, and automatically stops supplying power to the grid when the utility grid is not energized (Figure 5). A bi-directional interface is made between the photovoltaic system AC output circuits and the electric utility network, typically at an on-site distribution panel or service entrance. This allows the AC power produced by the photovoltaic system to either supply on-site electrical loads, or to back feed the grid when the photovoltaic system output is greater than the on-site load demand. At night and during other periods when the electrical loads are greater than the photovoltaic system output, the balance of power required by the loads is received from the electric utility. This safety feature is required in all grid-connected photovoltaic systems, and ensures that the photovoltaic system will not continue to operate and feed back onto the utility grid when the grid is down for service or repair.

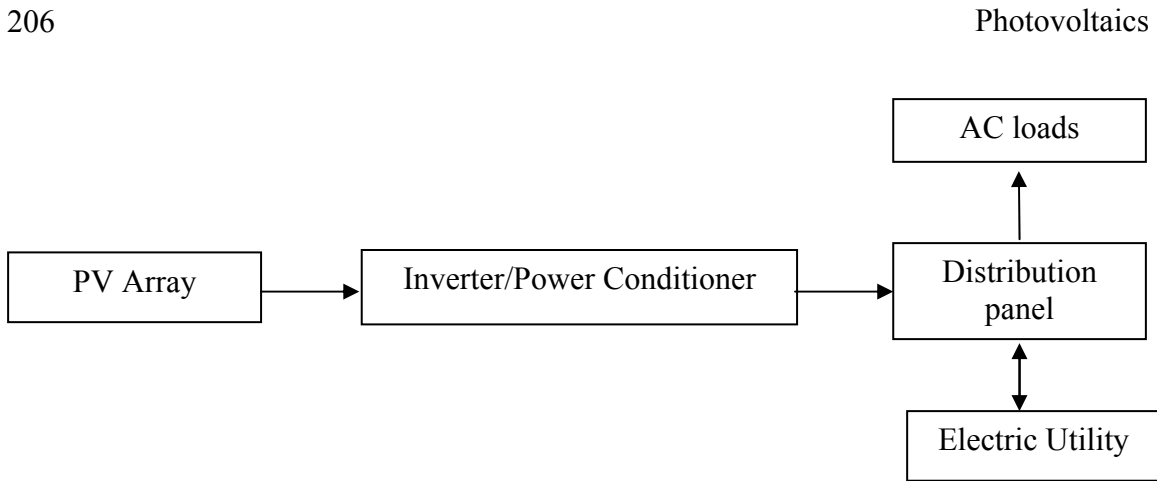

Fig.5. Diagram of grid-connected photovoltaic system

6.2. Stand-Alone photovoltaic systems

Stand-alone photovoltaic systems are designed to operate independent of the electric utility grid, and are generally designed and sized to supply certain DC and/or AC electrical loads. These types of systems may be powered by a photovoltaic array only, or may use wind, an engine-generator or utility power as an auxiliary power source in what is called a photovoltaic -hybrid system. The simplest type of stand-alone photovoltaic system is a direct-coupled system, where the DC output of a photovoltaic module or array is directly connected to a DC load (Figure 6). Since there is no electrical energy storage (batteries) in direct-coupled systems, the load only operates during sunlight hours, making these designs suitable for common applications such as ventilation fans, water pumps, and small circulation pumps for solar thermal water heating systems. Matching the impedance of the electrical load to the maximum power output of the photovoltaic array is a critical part of designing well-performing direct-coupled system. For certain loads such as positive-displacement water pumps; a type of electronic DC-DC converter, called a maximum power point tracker (MPPT) is used between the array and load to help better utilize the available array maximum power output.

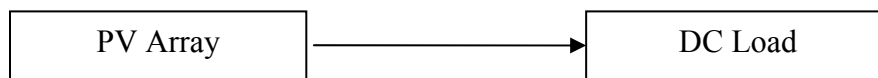

Fig.6. Simplest type of stand-alone PV system

In many stand-alone photovoltaic systems, batteries are used for energy storage. Figure 7 shows a diagram of a typical stand-alone PV system powering DC and AC loads. Figure 8 shows how a typical photovoltaic hybrid system might be configured.

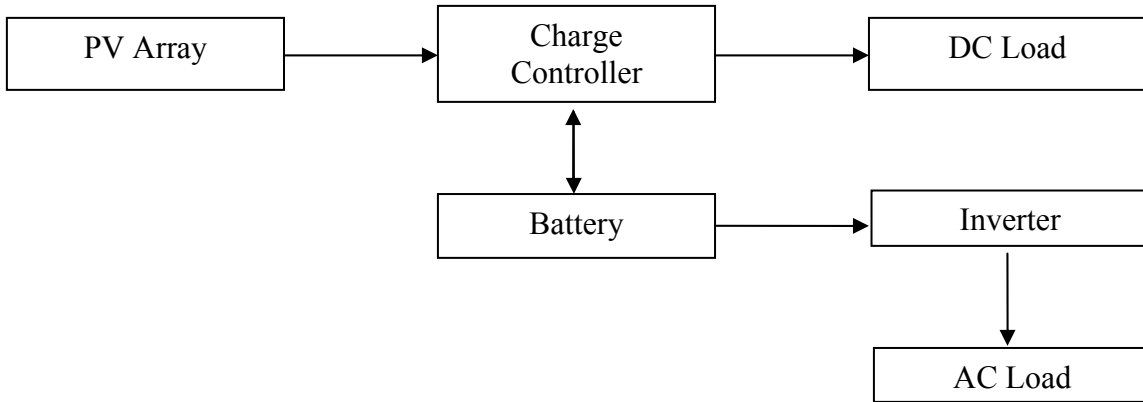

Fig.7. Diagram of stand-alone PV system with battery storage powering DC and AC loads

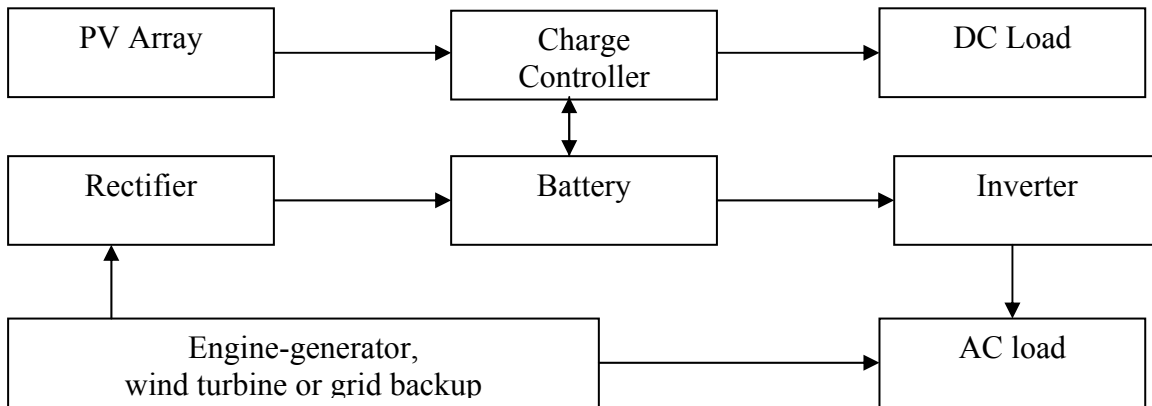

Fig.8. Diagram of photovoltaic hybrid system

7. Non-silicon based photovoltaic systems

The alternative material and technology used in manufacturing photovoltaic components, termed as second and third generation photovoltaic technologies include less-costly raw material and manufacturing techniques. Second generation photovoltaic imply thin-film solar cells, that use amorphous silicon or other compounds with semi-conducting properties, which are deposited on flexible substrates ranging from glass to plastics and other polymers. Third generation technologies include Organic, Nano and Spheral

technologies. Most of these are presently in the process of development and are soon expected to be commercially produced

7.1. Thin film technology

Thin-film silicon solar cells offset many of the disadvantages of the conventional silicon cells by using a fraction of the pure silicon required in manufacturing solar cells. They are also easier to manufacture and easy to use in a variety of applications.

Thin film solar cells are made by depositing a thin layer of semiconductor on a supporting material (substrates) such as glass, stainless steel or polyimide through a process called Chemical Vapor deposition. The materials selected for deposition are strong light absorbers, most commonly amorphous silicon (a-Si), cadmium telluride (CdTe) and copper indium (gallium) diselenide (CIS or CIGS). These materials are suitable for deposition over large substrate areas (up to 1 meter) and hence allow high volume manufacturing. In terms of costs, amorphous silicon thin film solar cells use less than 1% of the silicon used in conventional cells, and the material costs are also lower for cells using CdTe or CIS technologies. These cells also do not require assembling and are flexible, hence having versatile applications. The efficiency levels of these cells range between 6 to 8 %. The market share for thin-film technology based solar cells ranged between 7 and 8 % in 2002

7.2. Amorphous Silicon (a-Si)

Used mostly in consumer electronic products, which require lower power output and cost of production, amorphous silicon has been the dominant thin-film PV material since it was first discovered in 1974. Amorphous silicon is a non-crystalline form of silicon *i.e.* its silicon atoms are disordered in structure. A significant advantage of a-Si is its high light absorptivity, about 40 times higher than that of single-crystal silicon. Therefore only a thin layer of a-Si is sufficient for making PV cells (about 1 micrometer thick as compared to 200 or more micrometers thick for crystalline silicon cells). Also, a-Si can be deposited on various low-cost substrates, including steel, glass and plastic, and the manufacturing process requires lower temperatures and thus less energy. So the total material costs and manufacturing costs are lower per unit area as compared to those of crystalline silicon cells.

Despite the promising economic advantages, a-Si still has two major roadblocks to overcome. One is the low cell energy conversion efficiency, ranging between 5%, and the other is the outdoor reliability problem in which the efficiency degrades within a few months of exposure to sunlight, losing about 10 to 15%. The average price for a a-Si module cost about \$7 per watt in 1995.

7.3. Cadmium Telluride (CdTe)

As a polycrystalline semiconductor compound made of cadmium and tellurium, CdTe has a high light absorptivity level, only about a micrometer thick can absorb 90% of the solar spectrum. Another advantage is that it is relatively easy and cheap to manufacture by processes such as high-rate evaporation, spraying or screen printing. The conversion efficiency for a CdTe commercial module is about 7%, similar to that of a-Si. The instability of cell and module performance is one of the major drawbacks of using CdTe for PV cells. Another disadvantage is that cadmium is a toxic substance. Although very little cadmium is used in CdTe modules, extra precautions have to be taken in manufacturing process.

7.4. Copper Indium Diselenide (CuInSe₂, or CIS)

A polycrystalline semiconductor compound of copper, indium and selenium, CIS has been one of the major research areas in the thin film industry. The reason for it to receive so much attention is that CIS has the highest “research” energy conversion efficiency of 17.7% in 1996 is not only the best among all the existing thin film materials, but also came close to the 18% research efficiency of the polycrystalline silicon PV cells. (A prototype CIS power module has a conversion efficiency of 10 %.) Being able to deliver such high energy conversion efficiency without suffering from the outdoor degradation problem, CIS has demonstrated that thin film PV cells are a viable and competitive choice for the solar industry in the future.

CIS is also one of the most light-absorbent semiconductors; 0.5 micrometers can absorb 90% of the solar spectrum. CIS is an efficient but complex material. Its complexity makes it difficult to manufacture. Also, safety issues might be another concern in the manufacturing process as it involves hydrogen selenide, an extremely toxic gas. So far, CIS is not commercially available yet although Siemens Solar has plans to commercialize CIS thin-film PV modules.

7.5. Nanotechnology in photovoltaic

Various nanosize materials are under investigation; the major advantage of nanoparticle in the field of photovoltaics is increases in the charge transfer rate and tunability, which can be achieved by reducing the particle size. By controlling the particle size one can tune the band gap of the material so that it matches well with the solar spectrum and render the nanoparticles ideal for photovoltaic applications. Various attempts have been under investigation and it is believed that the appropriate photovoltaic system with maximum efficiency will be achieved in sooner.

7.6. Organic technology

Organic solar cells are based on the photosynthesis process in plants. The absorption of light in organic cells is done by the 'dye' which substitutes for the silicon in conventional cells. This light causes the dye molecules to excite and release electrons that are converted to electrical energy. The use of chemicals called dyes for the conversion process has led to organic cells also being known as "dye-sensitized solar cells". The absorption of light occurs in dye molecules that are in a highly porous film of Titanium dioxide (TiO_2). This causes the electron to be injected into TiO_2 and is conducted to the transparent conductive oxide layer. The material and manufacturing costs of these cells are relatively much lower than conventional silicon photovoltaic cells. However, the low efficiency rates (3 - 5 %) result in an overall increase in the costs. This technology is presently being developed and expected to be produced commercially.

References

1. http://www.azom.com/details.asp?ArticleID=1156#_From_Cells_to
2. <http://www.fsec.ucf.edu/pvt/pvbasics/index.htm#HistofPV>
3. http://www1.eere.energy.gov/solar/photoelectric_effect.html
4. <http://www.infinitepower.org/pdf/FactSheet-11.pdf>

Chapter – 12

PHOTO ELECTROCHEMICAL CELLS

S. Navaladian

The importance of the energy sector is understood by human beings as the inventions of so many instruments, weapons, equipment according to the requirements for well being. The energy sources like petroleum products, coal, nuclear plants are one way or other are used effectively by mankind. Since these sources are conventional sources, they can not be long lasting sources as long as mankind exists. As far as the prediction about the availability fossil fuels, they can available only up to 50 more years – the world population increase drastically. As a result the mankind is in the critical situation of looking for the alternative fuels. Lot of efforts has been put on the research on the energy sector, particularly the alternative energy source development. Even before a century ago, the efforts on harnessing the sunlight by the scientists in the various countries. The sunlight is an open energy source for all except to the polar regions of earth where sun is seen rarely. By using the photo-active materials trapping the light energy from the sunlight and converting on to fuel or electric power is possible. This has been with solid interfaces of P-N junction. The potential difference created by P-N junction imparts the current in circuit. Instead of solid interface if an electrolyte is interfaced between photoactive material (semiconductor) anode and noble metal cathode in electrolyte medium, the electricity will be generated. This is known as photo electrochemical cells. The electrochemical reaction takes place between the electrodes and electrolytes particularly, oxidation at photo anode and reduction at noble metal cathode.

Electrochemical cells

The cell which contains an anode and cathode in an electrolyte giving or withdrawing electrical energy with chemical reaction at the interface of electrolyte and electrode is called an electrochemical cell. If electrical power is withdrawn from the cell, it is called as Galvanic cell or voltaic cells. If the power is given to the cell, it is electrolytic cell.

Voltaic cell or galvanic cells

In this of cells, the chemical energy is converted to electrical energy. This Zinc more readily loses electrons than copper, so placing zinc and copper metal in solutions of their salts can cause electrons to flow through an external wire which leads from the zinc to the copper.

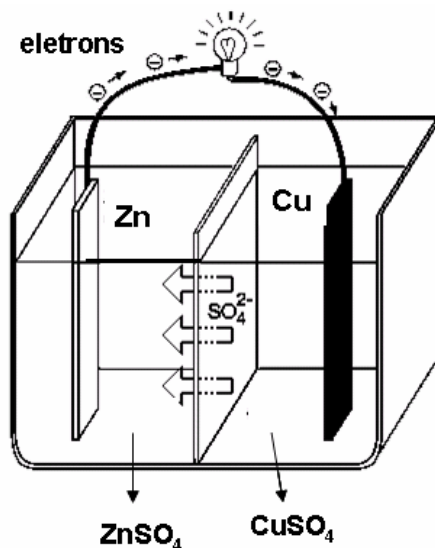
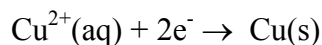
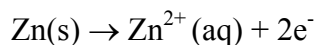

Fig.1. Sketch of a typical Galvanic cell

As a zinc atom provides the electrons, it becomes a positive ion and goes into aqueous solution, decreasing the mass of the zinc electrode. On the copper side, the two electrons received allow it to convert a copper ion from solution into an uncharged copper atom which deposits on the copper electrode, increasing its mass. The two reactions are typically written



The letters in parentheses denote that Zinc goes from a solid state (s) into an aqueous solution (aq) and vice versa for copper. The two reactions represented are called the half cell reactions. This cell is called Daniel cell.

In order for the voltaic cell to continue to produce an external electric current, there must be a movement of the sulfate ions in solution from the right to the left to balance the electron flow in the external circuit. The metal ions themselves must be prevented from moving between the electrodes, so some kind of porous membrane or other mechanism

must provide for the selective movement of the negative ions in the electrolyte from the right to the left.

Energy is required to force the electrons to move from the zinc to the copper electrode, and the amount of energy per unit charge available from the voltaic cell is called the electromotive force (emf) of the cell. Energy per unit charge is expressed in volts (1 volt = 1 joule/coulomb).

Clearly, to get energy from the cell, one must get more energy released from the oxidation of the zinc than it takes to reduce the copper. The cell can yield a finite amount of energy from this process, the process being limited by the amount of material available either in the electrolyte or in the metal electrodes. For example, if there were one mole of the sulfate ions SO_4^{2-} on the copper side, then the process is limited to transferring two moles of electrons through the external circuit. The amount of electric charge contained in a mole of electrons is called the Faraday constant, and is equal to Avogadro's number times the electron charge:

$$\text{Faraday constant} = F = N_A e = 6.022 \times 10^{23} \times 1.602 \times 10^{-19} = 96,485 \text{ Coulombs / mole}$$

The energy yield from a voltaic cell is given by the cell voltage times the number of moles of electrons transferred times the Faraday constant.

$$\text{Electrical energy output} = nFE_{\text{cell}}$$

The cell emf E_{cell} may be predicted from the standard electrode potentials for the two metals. For the zinc/copper cell under the standard conditions, the calculated cell potential is 1.1 volts. This positive cell potential shows that cell is spontaneous.

Electrolytic cells

Water electrolysis cell is coming under electrolytic cells and here the electric power is given to the cell and H_2 and O_2 gases are released at the cathode and anode respectively. The electroplating also comes under this category. In these reactions the electrical energy is converted to chemical energy. Fig.2 . shows the schematic representation of the electrolytic cell for water electrolysis.

During the early history of the earth, hydrogen and oxygen gasses spontaneously reacted to form the water in the oceans, lakes, and rivers we have today. That spontaneous direction of reaction can be used to create water and electricity in a galvanic cell (as it does on the space shuttle). However, by using an electrolytic cell composed of water, two

electrodes and an external source emf one can reverse the direction of the process and create hydrogen and oxygen from water and electricity. The reaction at the anode is the oxidation of water to O_2 and acid while the cathode reduces water into H_2 and hydroxide ion. That reaction has a potential of -2.06 V at standard conditions. However, this process is usually performed with $[H^+] = 10^{-7}\text{ M}$ and $[OH^-] = 10^{-7}\text{ M}$, the concentrations of hydronium and hydroxide ions in pure water. Applying the Nernst Equation to calculate the potentials of each half-reaction, we find that the potential for the electrolysis of pure water is -1.23 V . To make the electrolysis of water to occur, one must apply an external potential (usually from a battery of some sort) of greater than or equal to 1.23 V . In practice, however, it is necessary to use a slightly larger voltage to get the electrolysis to occur on a reasonable time scale. Pure water is impractical to use in this process because it is an electrical insulator. That problem is circumvented by the addition of a minor amount of soluble salts that turn the water into a good conductor. Such salts have subtle effects on the electrolytic potential of water due to their ability to change the pH of water. Such effects from the salts are generally so small that they are usually ignored.

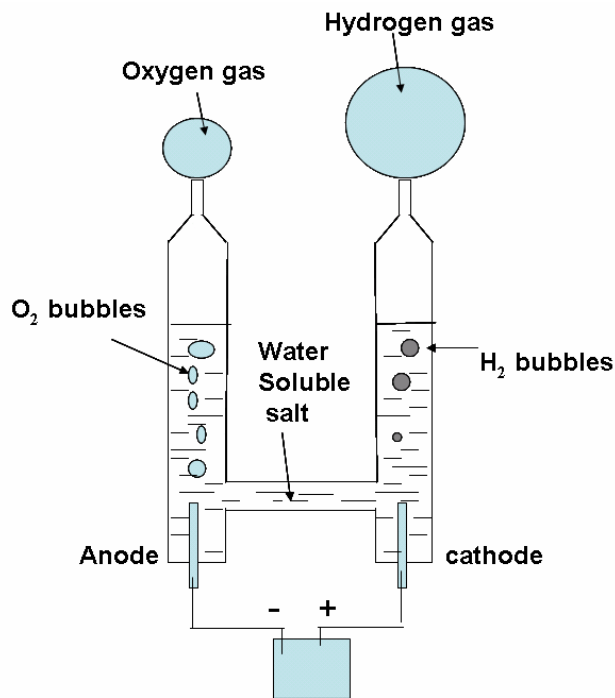

Fig.2. Setup for the electrolysis of Water

Photo electrochemical cells

This photo electrochemical cell is also coming under the voltaic cells. The difference between these galvanic cells and photo electrochemical cell, in principle, is chemical energy is converted into electrical energy in the former, whereas light energy is converted in the electrical energy or chemical energy in the form of fuel (H₂). The schematic representation of photo electrochemical is shown in the Fig.3. a and 3. b. The foundation of modern photo electrochemistry, marking its change from a mere support of photography to a thriving research direction on its own, was laid down by the work of Brattain and Garret and subsequently Gerischer who undertook the first detailed electrochemical and photo electrochemical studies of the semiconductor–electrolyte interface. Research on photo electrochemical cells went through a frantic period after the oil crisis in 1973, which stimulated a worldwide quest for alternative energy sources. Within a few years well over a thousand publications appeared. Investigations focused on Two types of cells whose principle of operation is shown in Fig.3. The first type is the regenerative cell, which converts light to electric power leaving no net chemical change behind. Photons of energy exceeding that of the band gap generate electron–hole pairs, which are separated by the electric field present in the space-charge layer. The negative charge carriers move through the bulk of the semiconductor to the current collector and the external circuit. The positive holes are driven to the surface where they are scavenged by the reduced form of the redox relay molecule (R), oxidizing it:



The oxidized form O is reduced back to R by the electrons that re-enter the cell from the external circuit. Much of the work on regenerative cells has focused on electron-doped (*n*-type) II/VI or III/V semiconductors using electrolytes based on sulphide/polysulphide, vanadium (II) /vanadium (III) or I₂/I⁻ redox couples. Conversion efficiencies of up to 19.6% have been reported for multijunction regenerative cells. The second type, photosynthetic cells, operate on a similar principle except that there are two redox systems: one reacting with the holes at the surface of the semiconductor electrode and the second reacting with the electrons entering the counter-electrode. In the example shown, water is oxidized to oxygen at the semiconductor photoanode and reduced to hydrogen at the cathode.

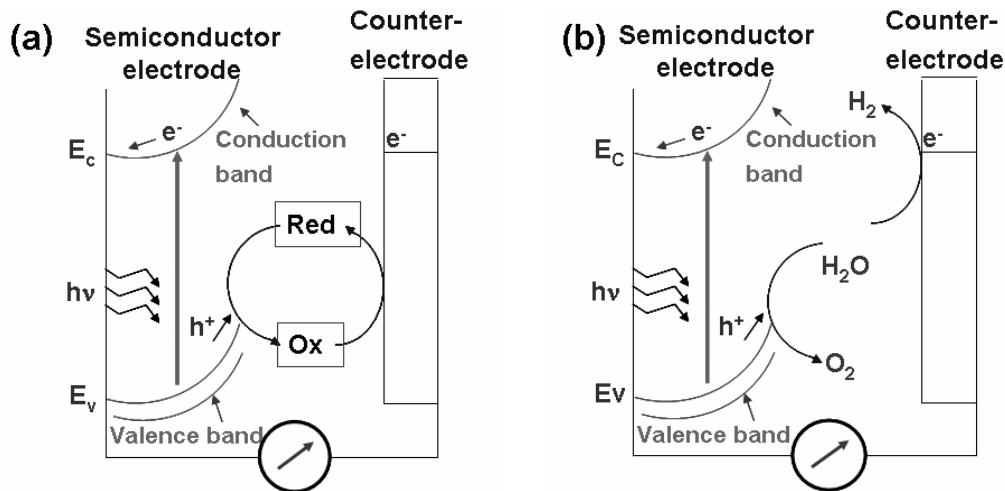

Fig.3. **Schematic** representation of principle of operation of photo electrochemical cells based on n-type semiconductors. **a**, Regenerative-type cell producing electric current from sunlight; **b**, a cell that generates a chemical fuel, hydrogen, through the photo-cleavage of water.

The overall reaction is the cleavage of water by sunlight. Titanium dioxide has been the favoured semiconductor for these studies, following its use by Fujishima and Honda for water photolysis. Unfortunately, because of its large band gap (3–3.2 eV), as shown in Fig.4), TiO₂ absorbs only the ultraviolet part of the solar emission and so has low conversion efficiencies. Numerous attempts to shift the spectral response of TiO₂ into the visible, or to develop alternative oxides affording water cleavage by visible light, have so far failed. In view of these prolonged efforts, disillusionment has grown about the prospects of photo electrochemical cells being able to give rise to competitive photovoltaic devices, as those semiconductors with band gaps narrow enough for efficient absorption of visible light are unstable against photo corrosion. The width of the band gap is a measure of the chemical bond strength. Semiconductors stable under illumination, typically oxides of metals such as titanium or niobium, therefore have a wide band gap, an absorption edge towards the ultraviolet and consequently insensitivity to the visible spectrum. The resolution of this dilemma came in the separation of the optical absorption and charge-generating functions, using an electron

Transfer sensitizer absorbing in the visible to inject charge carriers across the semiconductor–electrolyte junction into a substrate with a wide band gap, and therefore stable. Fig.3.a and 3.b shows the operational principle of such a device.

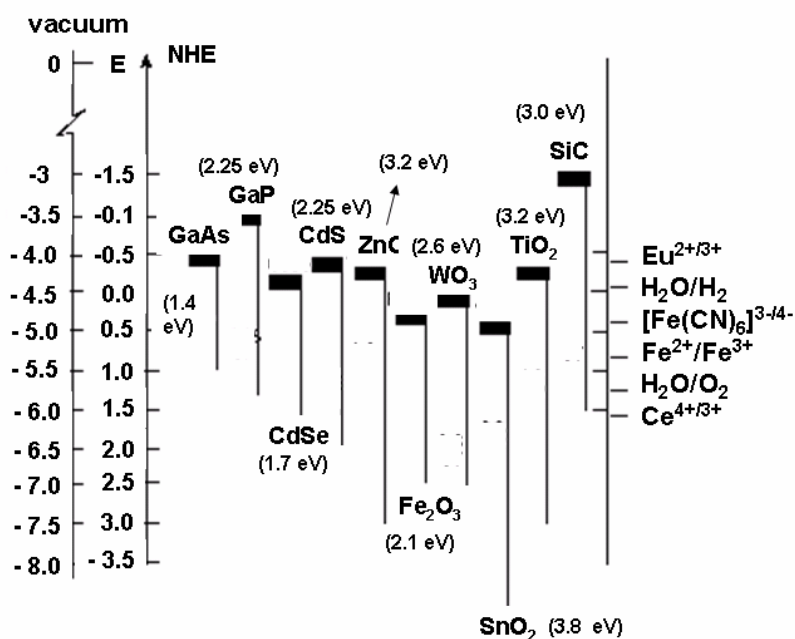

Fig.4. Band positions of several semiconductors in contact with aqueous electrolyte at pH 1.

The lower edge of the conduction band and upper edge of the valence band are presented along with the band gap in electron volts. The energy scale is indicated in electron volts using either the normal hydrogen electrode (NHE) or the vacuum level as a reference. Note that the ordinate presents internal and not free energy. The free energy change of an electron–hole pair is smaller than the band gap energy due to the translational entropy of the electrons and holes in the conduction and valence band, respectively. On the right side the standard potentials of several redox couples are presented against the standard hydrogen electrode potential.

Nanocrystalline junctions and interpenetrating networks

The need for dye-sensitized solar cells to absorb far more of the incident light was the driving force for the development of mesoscopic semiconductor materials — minutely

structured materials with an enormous internal surface area — which have attracted great attention during recent years. Mesoporous oxide films are made up of arrays of tiny crystals measuring a few nanometers across. Oxides such as TiO_2 , ZnO , SnO_2 and Nb_2O_5 , or chalcogenides such as CdSe , are the preferred compounds. These are interconnected to allow electronic conduction to take place. Between the particles are mesoscopic pores filled with a semi conducting or a conducting medium, such as a *p*-type semiconductor, a polymer, a hole transmitter or an electrolyte. The net result is a junction of extremely large contact area between two interpenetrating, individually continuous networks. Particularly intriguing thing is the ease with which charge carriers percolate across the mesoscopic particle network, making the huge internal surface area electronically addressable. Charge transport in such mesoporous systems is under intense investigation today and is best described by a random walk model. The semiconductor structure, typically 10 mm thick and with a porosity of 50%, has a surface area available for dye chemisorption over a thousand times that of a flat, unstructured electrode of the same size. If the dye is chemisorbed as a monomolecular layer, enough can be retained on a given area of electrode to provide absorption of essentially all the incident light. Fig.5. shows an electron micrograph of a nanocrystalline TiO_2 film with a grain size in the range of 10–80 nm. The nanostructure of the semiconductor introduces profound changes in its photo electrochemical properties. Of great importance is the fact that a depletion layer cannot be formed in the solid - the particles are simply too small. The voltage drop within the nanocrystals remains small under reverse bias, typically a few mV. As a consequence there is no significant local electric field present to assist in the separation of photogenerated electron–hole pairs. The photo response of the electrode is determined by the rate of reaction of the positive and negative charge carriers with the redox couple present in the electrolyte. If the transfer of electrons to the electrolyte is faster than that of holes, then a cathodic photocurrent will flow, like in a *p*-type semiconductor/liquid junction. In contrast, if hole transfer to the electrolyte is faster, then anodic photocurrent will flow, as in *n*-type semiconductor photo electrochemical cells.

Striking confirmation of the importance of these kinetic effects came with the demonstration that the same nanocrystalline film could show alternatively *n*- or *p*-type behavior, depending on the nature of the hole or electron scavenger present in the

electrolyte phase. This came as a great surprise to a field where the traditional thinking was to link the photo response to formation of a charge-depletion layer at the semiconductor–electrolyte interface.

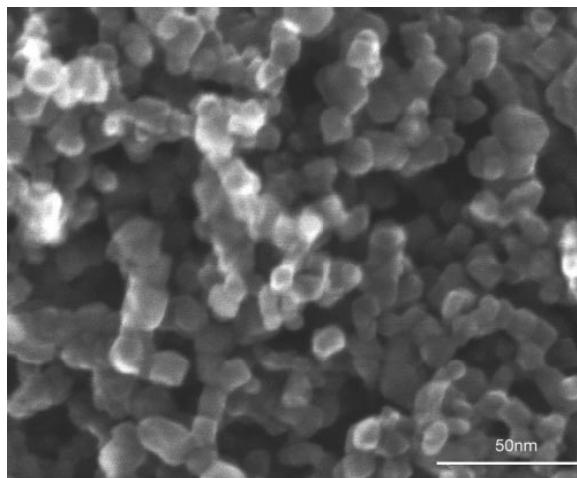

Fig.5. Scanning electron micrograph of the surface of a mesoporous anatase film prepared from a hydro thermally processed TiO_2 colloid. The exposed surface planes have mainly $\{101\}$ orientation.

What, then, is the true origin of the photo voltage in dye-sensitized solar cells? In the conventional picture, the photo voltage of photo electrochemical cells does not exceed the potential drop in the space-charge layer but nanocrystalline cells can develop photo voltages close to 1 V even though the junction potential is in the mV range. It has been suggested that a built-in potential difference at the back contact of the nanocrystalline film with the conducting glass is responsible for the observed photo voltage. Other evidence suggests that under illumination, electron injection from the sensitizer increases the electron concentration in the nanocrystalline electrode, raising the Fermi level of the oxide and thus shifting its potential. From recent electrical impedance studies, it seems that both changes — the potential drop across the back contact and the Fermi level shift of the TiO_2 nanoparticles — contribute to the photo voltage of dye-sensitized solar cells. Accumulations layers can be produced in the nanocrystals under forward bias when majority carriers are injected, rendering the film highly conductive. Under reverse bias the carriers are withdrawn, turning it into an insulator. Thus, by changing the applied

potential, the film can be switched back and forth from a conducting to an insulating state. Space-charge limitation of the current (arising from limitation of the density of charge carriers because they are repelled by each other's electric field) is not observed as the injected majority carriers are efficiently screened by the electrolyte present in the pores surrounding the nanoparticles.

The factors controlling the rate of charge carrier percolation across the nanocrystalline film are under intense scrutiny. A technique known as intensity-modulated impedance spectroscopy has proved to be an elegant and powerful tool, for addressing these and other important questions related to the characteristic time constants for charge carrier transport and reaction dynamics. An interesting feature specific to nanocrystalline electrodes is the appearance of quantum confinement effects. These appear when the films are made up of small quantum dots, such as 8-nm-sized CdTe particles. Such layers have a larger band gap than the bulk material, the band edge position being shifted with respect to the positions indicated in Figure. 4 for macroscopic materials.

The conduction band redox potential is lowered and that of the valence band is increased. As a consequence, electrons and holes can perform reduction and oxidation reactions that cannot proceed on bulk semiconductors. The astounding photo electrochemical performance of nanocrystalline semiconductor junctions is illustrated in Fig. 7. Where the comparison the photo response of an electrode made of single-crystal anatase, one of the crystal forms of TiO_2 , with that of a mesoporous TiO_2 film.

Both electrodes are sensitized by the ruthenium complex $\text{cis-RuL}_2(\text{SCN})_2$ (L is 2,2'-bipyridyl-4-4'-dicarboxylate), which is adsorbed as a monomolecular film on the titania surface.

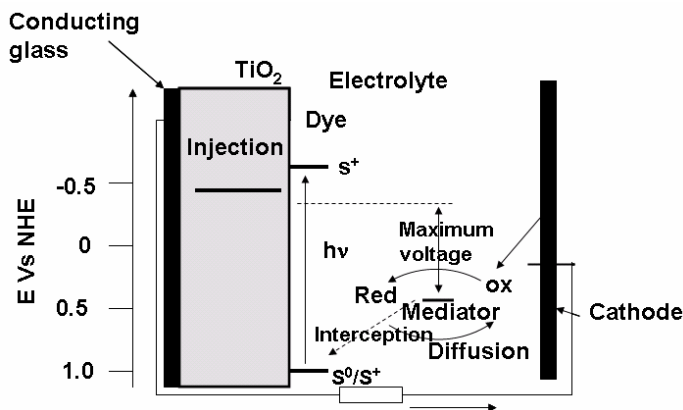

Fig.6. Schematic of operation of the dye-sensitized electrochemical photovoltaic cell.

The incident-photon-to-current conversion efficiency (IPCE) is plotted as a function of wavelength. The photo anode, made of a mesoporous dye-sensitized semiconductor, receives electrons from the photo-excited dye which is thereby oxidized, and which in turn oxidizes the mediator, a redox species dissolved in the electrolyte. The mediator is regenerated by reduction at the cathode by the electrons circulated through the external circuit. The IPCE value obtained with the single-crystal electrode is only 0.13% near 530 nm, where the sensitizer has an absorption maximum, whereas it reaches 88% with the nanocrystalline electrode — more than 600 times as great. The photocurrent in standard sunlight augments 10^3 – 10^4 times when passing from a single crystal to a nanocrystalline electrode (standard, or full, sunlight is defined as having a global intensity (I_s) of $1,000 \text{ W m}^{-2}$, air mass 1.5; air mass is the path length of the solar light relative to a vertical position of the Sun above the terrestrial absorber). This striking improvement is due largely to the far better light harvesting of the dye-sensitized nanocrystalline film as compared with a flat single-crystal electrode, but is also due, at least in part, to the mesoscopic film texture favoring photo generation and collection of charge carriers.

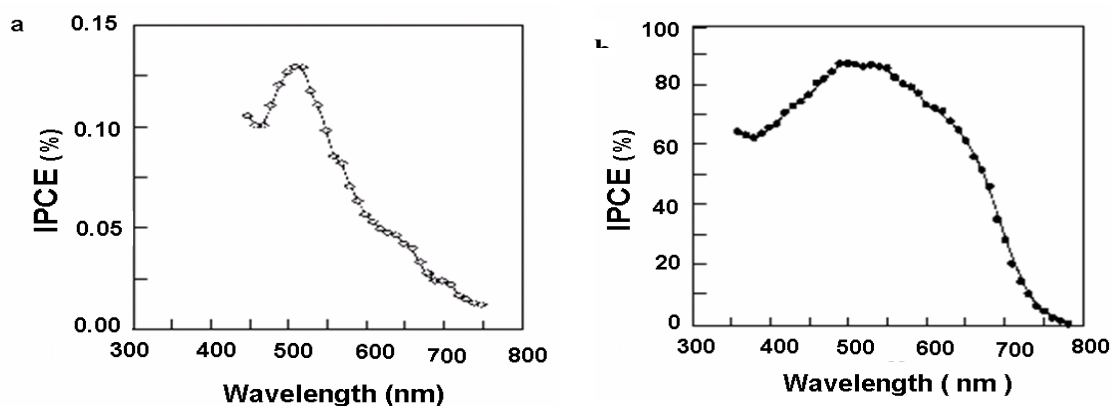

Fig.7. The nanocrystalline effect in dye-sensitized solar cells. In both cases, TiO_2 electrodes are sensitized by the surface-anchored ruthenium complex $\text{cis-RuL}_2(\text{SCN})_2$. The incident-photon-to-current conversion efficiency is plotted as a function of the excitation wavelength. **a**, Single-crystal anatase cut in the (101) plane. **b**, Nanocrystalline anatase film. The electrolyte consisted of a solution of 0.3M LiI and 0.03M I_2 in acetonitrile

The overall conversion efficiency of the dye-sensitized cell is determined by the photocurrent density measured at short circuit (i_{ph}), the open-circuit photo-voltage (V_{oc}), the fill factor of the cell (ff) and the intensity of the incident light (I_s) $ff I_{ph} V_{oc} / I_s$. Under full sunlight, short-circuit photocurrents ranging from 16 to 22 mA cm⁻² are reached with state-of-the-art ruthenium sensitizers, while V_{oc} is 0.7–0.8 V and the fill factor values are 0.65–0.75. A certified overall power conversion efficiency of 10.4% has been attained at the US National Renewable Energy Laboratory³⁰. Although this efficiency makes dye-sensitized cells fully competitive with the better amorphous silicon devices, an even more significant parameter is the dye lifetime achieved under working conditions. For credible system performance, a dye molecule must sustain at least 10⁸ redox cycles of photo-excitation, electron injection and regeneration, to give a device service life of 20 years. The use of solvents such as valeronitrile, or γ -butyrolactone, appropriately purified, in the electrolyte formulation provides a system able to pass the standard stability qualification tests for outdoor applications, including thermal stress for 1,000 h at 85 °C, and this has been verified independently.

Tandem cells for water cleavage by visible light

The advent of nanocrystalline semiconductor systems has rekindled interest in tandem cells for water cleavage by visible light, which remains a highly prized goal of photo electrochemical research. The ‘brute force’ approach to this goal is to use a set of four silicon photovoltaic cells connected in series to generate electricity that is subsequently passed into a commercial-type water electrolyzer. Solar-to-chemical conversion efficiencies obtained are about 7%. Much higher efficiencies in the range of 12–20% have been reported for tandem cells based on III/V semiconductors, but these single-crystal materials cost too much for large-scale terrestrial applications. A low-cost tandem device that achieves direct cleavage of water into hydrogen and oxygen by visible light was developed recently. This is based on two photosystems connected in series as shown in the electron flow diagram of Fig. 8. A thin film of nanocrystalline tungsten trioxide, WO₃, or Fe₂O₃ serves as the top electrode absorbing the blue part of the solar spectrum. The valence band holes (h^+) created by band-gap excitation of the film oxidize water to oxygen and the conduction-band electrons are fed into the second photosystem

consisting of the dye-sensitized nanocrystalline TiO_2 cell discussed above. The latter is placed directly under the WO_3 film, capturing the green and red part of the solar spectrum that is transmitted through the top electrode. The photo voltage generated by the second photosystem enables hydrogen to be generated by the conduction-band electrons.

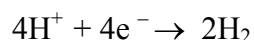
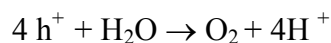

The overall reaction corresponds to the splitting of water by visible light. There is close analogy to the 'Z-scheme' (named for the shape of the flow diagram) that operates in photosynthesis. In green plants, there are also two photosystems connected in series, one that oxidizes water to oxygen and the other generating the compound NADPH used in fixation of carbon dioxide. As discussed above, the advantage of the tandem approach is that higher efficiencies can be reached than with single junction cells if the two photosystems absorb complementary parts of the solar spectrum. At present, the overall conversion efficiency from standard solar light to chemical energy achieved with this device stands at 4.5%, and further improvements are underway.

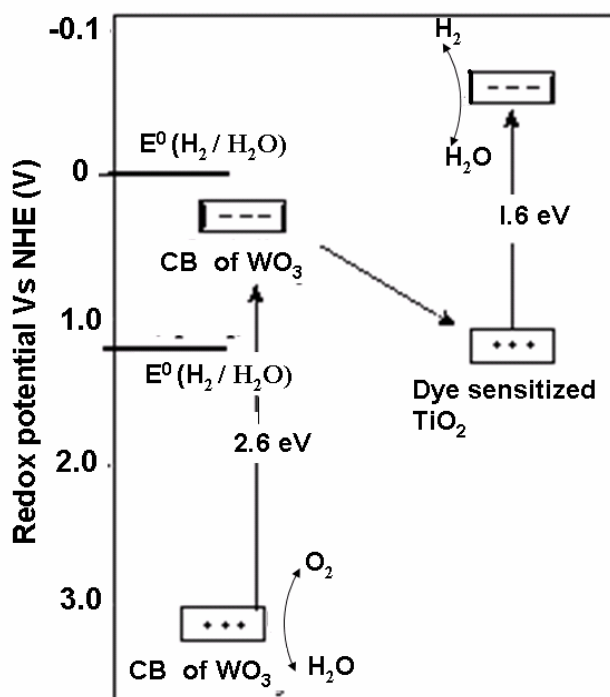

Fig.8. The Z-scheme of photocatalytic water decomposition by a tandem cell

Dye-sensitized solid heterojunctions and ETA cells

Interest is growing in devices in which both the electron- and hole-carrying materials are solids, but are grown as interpenetrating networks forming a heterojunction of large contact area. From conventional wisdom one would have predicted that solar cells of this kind would work very poorly, if at all. The disordered character of the junction and the presence of the huge interface are features one tries to avoid in conventional photovoltaic cells, because the disruption of the crystal symmetry at the surface produces electronic states in the band gap of the semiconductor, enhancing the recombination of photo generated carriers. The fact that molecular photovoltaic cells based on the sensitization of nanocrystalline TiO_2 were able to achieve overall conversion efficiencies from solar to electric power of over 10% encouraged work on solid-state analogues, that is, dye-sensitized heterojunctions. The first devices of this type used inorganic *p*-type semiconductors, for example CuI or CuSCN , as hole conductors replacing the redox electrolyte. Respectable conversion efficiencies exceeding 1% have been reached with such cells. But the lack of photostability of the Cu(I) compounds and the difficulty of realizing a good contact between the two mesoscopic inorganic materials still present considerable practical challenges. Organic charge-transport materials have advantages in this respect. An amorphous hole conductor can be introduced into the mesoporous TiO_2 film by a simple spin-coating process and readily adapts its form to the highly corrugated oxide surface. Cells based on a spirobisfluorene-connected arylamine hole transmitter³⁸, which fills the pores of a dye-sensitized nanocrystalline TiO_2 film, have reached a conversion efficiency of 2.56% at full sunlight³⁹. The high open-circuit voltage of these devices, exceeding 900 mV, is particularly noteworthy and promising for further substantial improvements in performance. In general, dye-sensitized heterojunction cells offer great flexibility because the light absorber and charge-transport material can be selected independently to obtain optimal solar energy harvesting and high photovoltaic output. The great advantage of such a configuration is that the charge carriers are generated by the dye precisely at the site of the junction where the electric field is greatest, enhancing charge separation.

Extremely thin absorber (ETA) solar cells are conceptually close to dye-sensitized heterojunctions. The molecular dye is replaced by an extremely thin (2–3 nm) layer of a

small-band-gap semiconductor, such as CuInS_2 . A hole conductor such as CuSCN is placed on top of the absorber, producing a junction of the PIN type (*p*-type semiconductor/insulator/*n*-type semiconductor). The structure has the advantage of enhanced light harvesting due to the surface enlargement and multiple scattering. Because photo-induced charge separation occurs on a length scale of a few nanometres, higher levels of defects and impurities can be tolerated than in flat thin-film devices, where the minority carriers are required to diffuse several microns. On the other hand, making PIN-junctions of such high contact area is difficult and this has hampered the performance of these cells. Their conversion efficiency so far has remained below 5%, which is less than one-third of the yield obtained with similar semiconductor materials in a flat junction configuration. Organic materials have the advantage of being cheap and easy to process. They can be deposited on flexible substrates, bending where their inorganic competitors would crack. The choice of materials is practically unlimited, and specific parts of the solar spectrum can be selectively absorbed. Although organic cells are still considerably less efficient than single-crystal gallium arsenide or silicon, progress has been impressive over the past few years. In particular, solar cells based on interpenetrating polymer networks, polymer/fullerene blends, halogen-doped organic crystals and the solid-state dye-sensitized devices mentioned above have shown surprisingly high solar conversion efficiencies, currently reaching values of 2–3%. Conducting polymers, for example poly-(phenylenevinylene) (PPV) derivatives or C60 particles, are attracting great interest as photovoltaic material. Bulk donor–acceptor heterojunctions are formed simply by blending the two organic materials serving as electron donor (*p*-type conductor) and electron acceptor (*n*-type conductor). The advantage of these new structures over the flat-junction organic solar cells investigated earlier is the interpenetration of the two materials that conduct positive and negative charge carriers, reducing the size of the individual phase domains to the nanometre range. This overcomes one of the problems of the first generation of organic photovoltaic cells: the unfavourable ratio of exciton diffusion length to optical absorption length. An exciton is a bound electron–hole pair produced by absorption of light; to be useful, this pair must reach the junction and there dissociate into two free charge carriers — but excitons typically diffuse only a few nanometres before recombining. Light is absorbed (and

generates excitons) throughout the composite material. But in the composite, the distance the exciton has to travel before reaching the interface is at most a few nanometres, which is commensurate with its diffusion length. Hence photo-induced charge separation can occur very efficiently. Conversion efficiency from incident photons to current of over 50% has been achieved with a blend containing PPV and methanofullerene derivatives⁴⁶. The overall conversion efficiency from solar to electric power under full sunlight achieved with this cell was 2.5%. Although these results are impressive, the performance of the cell declined rapidly within hours of exposure to sunlight. In contrast, the output of dye-sensitized solar cells is remarkably stable even under light soaking for more than 10,000 h. Similar long-term stability will be required for large-scale application of polymer solar cells.

Summary

Photovoltaic devices based on interpenetrating mesoscopic networks have emerged as a credible alternative to conventional solar cells. Common to all these cells is an ultrafast initial charge separation step, occurring in femtoseconds, and a much slower back-reaction.

This allows the charge carriers to be collected as electric current before recombination takes place. Table 1 compares the performance of the new photo electrochemical systems with conventional devices. Although still of lower efficiency, the nanostructured cells offer several advantages over their competitors. They can be produced more cheaply and at less of a cost in energy than silicon cells, for which 5 GJ have to be spent to make 1 m² of collector area. Unlike silicon, their efficiency increases with temperature, narrowing the efficiency gap under normal operating conditions. They usually have a bifacial configuration, allowing them to capture light from all angles. Transparent versions of different colour can readily be made that could serve as electric power-producing windows in buildings. These and other attractive features justify the present excitement about these cells and should aid their entry into a tough market. Although significant advances have been made, both in the basic understanding of photo electrochemical devices and in the development of systems with good conversion efficiency and stability, much additional research and development must be done before photo electrochemical systems can be seriously considered for practical solar energy conversion schemes.

Table 1. Performance of photovoltaic and photo electrochemical solar cells

Type of cell	Efficiency (%)		Research and technology needs
	Cell	Module	
Crystalline silicon	24	10–15	Higher reduction yields, lowering of cost and energy content
Multicrystalline silicon	18	9–12	Lower manufacturing cost and complexity
CuInSe ₂	19	12	Replace indium (too expensive and limited supply), replace CdS window layer, scale up production
Dye-sensitized nanostructured materials	10–11	7	Improve efficiency and high temperature stability, scale up production
Bipolar AlGaAs/Si photo electrochemical cells	19–20		Reduce materials cost, scale up
Organic solar cells	2–3		Improve stability and efficiency

*Efficiency defined as conversion efficiency from solar to electrical power.

References

1. <http://atom.ecn.purdue.edu/~vurade/PEC%20Generation%20of%20Hydrogen/>
2. <http://www.sciencemag.org/cgi/content/summary/301/5635/926>
3. M. Gratzel, *Nature*, 2001(414) 338.
4. J. Krüger, U. Bach, and M. Grätzel, *Appl. Phys. Lett.* 2001 (79) 2085.
5. Halls, J. J. M., Pickler, K., Friend, R. H., Morati, S. C. and Holmes, A. B.. *Nature* 1995 (376) 498.
6. G. Yu, J., Gao, J. C. Hummelen, F. Wudi, and A. J Heeger, *Science* 1995 (270) 1789.
7. D. Wöhrle. D. Meissner. *Adv. Mat.* 1991 (130) 129.

Chapter – 13

HYDROGEN PRODUCTION

G. Magesh

Hydrogen: Fuel of the Future

Hydrogen is emerging as the favorite alternative to fossil fuels as an energy carrier. Auto manufacturing, for example, have come up with models that run on either hydrogen used as fuel in internal combustion engines (ICEs), or fuel cell cars that use gasoline in the ICE and, additionally, a fuel cell producing electricity-using hydrogen as fuel. Recently, a car running on just hydrogen completed a journey through continental Australia -- the grueling 4000 kilometer long journey proved that these cars are as tough as any other. The US government has embarked on an initiative to develop technology for the production, transportation and storage of hydrogen and using it as an alternative fuel as and when the need arises. But there are plenty of technological challenges that need to be addressed before hydrogen can become the day-to-day fuel.

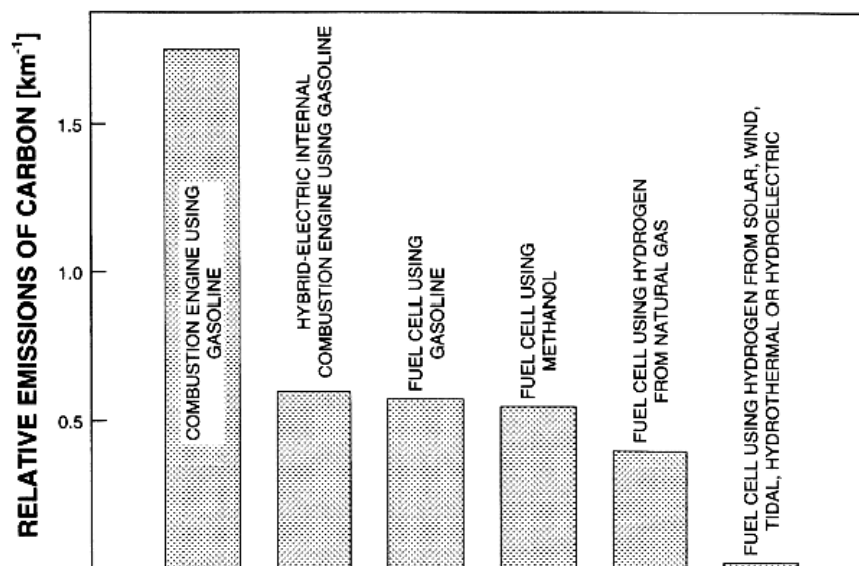

Fig.1. Relative emissions of carbon for various fuels and combustion engines

Fig.1. compares the relative carbon emissions per kilometer resulting from the use of gasoline versus hydrogen in ICE alone as well as hybrid ICE + fuel cell vehicles. It is

apparent that the use of fuel cell powered vehicles using hydrogen generated from renewable energy sources brings down the emissions to almost zero.

The advantages of hydrogen as a universal energy medium are:

1. The combustion of hydrogen results in the formation of steam and liquid water. In this respect, the use of hydrogen is completely safe from environmental standpoint.
2. It is non-toxic.
3. It is easily assimilated into the biosphere: its combustion products are recycled by plants in the form of carbohydrates.
4. It is possible to produce hydrogen from the most abundant chemical on earth: water. Hydrogen can be obtained electrolytically, photoelectrochemically, thermochemically, by direct thermal decomposition or biochemically from water.
5. Hydrogen can be used as a feedstock for the chemical industry, enabling the production of entire gamut of chemicals from hydrogen and conventional petrochemicals.
6. It is the most suitable fuel for use in fuel cells - direct conversion of chemical energy into electricity without the heat route with an enhanced efficiency.
7. Transmission of energy in the form of hydrogen is more economical than through high voltage AC lines for large distances.

Methods of producing hydrogen

Hydrogen is the most abundant element in the Universe. Hydrogen is the simplest of atoms, composed of one proton and one electron. But pure, diatomic hydrogen (H_2) — the fuel of choice for fuel cells — does not exist naturally. Since hydrogen easily combines with other elements, one is most likely to find it chemically bound in water, biomass, or fossil fuels.

To get hydrogen into a useful form, it must be extracted from one of these sources. This process requires energy. Accordingly, the cleanliness and renewability of this energy is of critical importance. While a hydrogen – oxygen fuel cell operates without producing emissions, producing hydrogen can give rise to significant greenhouse gases and other harmful byproducts. Once obtained, hydrogen is a nearly ideal energy carrier. The various ways to obtain hydrogen are :

Direct electrolysis

Water electrolysis involves passing an electric current through water to separate it into hydrogen (H₂) and oxygen (O₂). Hydrogen gas rises from the negative cathode and oxygen gas collects at the positive anode. The reactions involved in the electrolysis of water are:

Reduction electrode (Cathode):

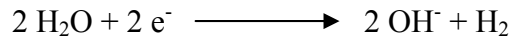

Oxidation electrode (Anode):



Complete cell reaction:

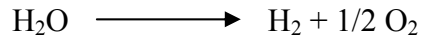

The values of the cathode and anode half-cell potentials, are known to be 0.401 V and -0.828 V respectively at 25°C at a pH of 14. If the activities of water and the gaseous species are considered unity, the cathode and anode potentials required according to Nernst equation will be:

$$E_c = -0.828 - 0.059 \log a_{\text{OH}^-}$$

$$E_a = 0.401 - 0.059 \log a_{\text{OH}^-}$$

And the potential required to split water into H₂ and O₂, i.e. E_a - E_c is equal to 1.229 V. Though the theoretical potential is 1.23 V for water electrolysis, in practice the actual water decomposition will occur only above 1.7 V. The extra potential, which is essential for the water decomposition, is called over potential. Overvoltage is evaluated mainly as a function of current and temperature. Overvoltages are composed of activation or charge transfer overvoltage, concentration or diffusion or mass transfer overvoltage and resistance or ohmic over voltage. In general, an aqueous solution of caustic potash or soda is used as the electrolyte for water electrolysis. The nature of anode and cathode is decided based on their hydrogen and oxygen over voltages in the electrolytic medium in addition to their stability in the particular medium. The cathode and anode are separated by a diaphragm, which prevents the mixing of hydrogen and oxygen gases produced at the cathode and anode surfaces respectively. The diaphragm should be stable in the electrolyte and minimizes the diffusion of gas molecules without affecting the conductivity of the medium.

Effect of temperature and pH on the decomposition potential

The amount of electricity required to produce one mole of hydrogen by splitting one mole of water is 2 Faradays, which is equal to 236.96 kJ of energy. Whereas, heat generated by combustion of one mole of hydrogen is 285.58 kJ at 25 °C. The extra energy of 48.63 kJ must be absorbed from the surrounding of electrolytic cell if the water is electrolyzed with 1.229 V at 25 °C. Applying electrical energy of 285.58 kJ, *i.e.* 1.481 V, to a water electrolyzer at 25 °C would generate hydrogen and oxygen isothermally. The values 1.229 and 1.481 V are called as the reversible and thermo-neutral voltage. The variation of reversible and thermo-neutral voltage with temperature is shown in Fig. 2.

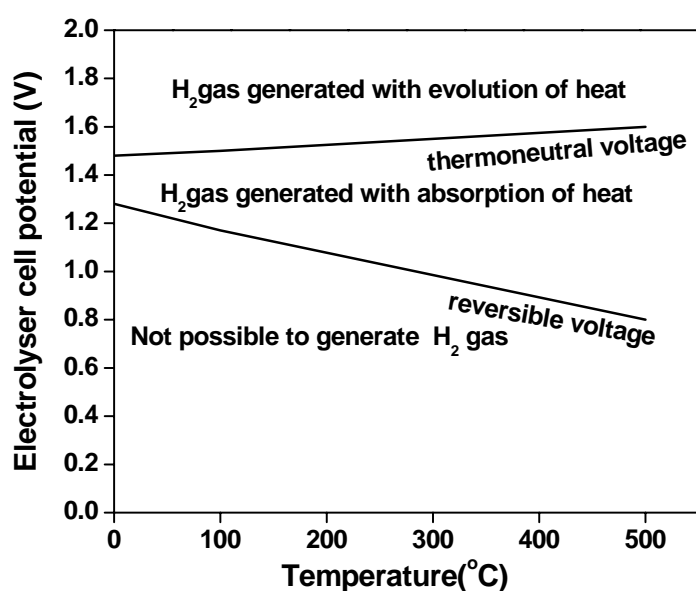

Fig.2. Variation of cell potential as a function of temperature

It can be seen from the Fig. 2, that when the temperature increases the reversible voltage decreases, whereas the thermo-neutral voltage slightly increases with temperature. It can also be seen from Fig. 2 that, in the region below the reversible voltage, hydrogen production is not possible. In the second region, the hydrogen is evolved with absorption of heat from the surrounding. In the third region, the hydrogen is evolved with liberation of heat, *i.e.* the extra energy as potential above the thermo-neutral potential is released as heat energy. In general, the commercial industrial electrolytic cells are operating between 60-80 °C. The hydrogen and oxygen evolution potentials at various pH are shown in the Fig.3. It can be seen from the figure that the net potential needed for the hydrogen and oxygen evolution at any given pH between 0 to 14 is 1.229 V at 25 °C.

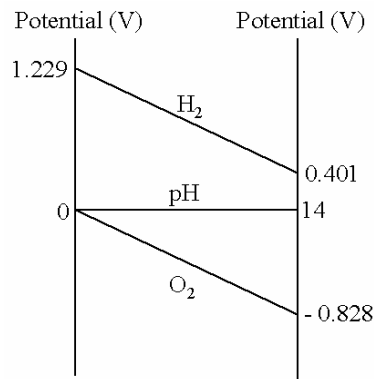

Fig.3. Hydrogen and oxygen electrode potential against pH of the electrolyte

Due to the corrosive action on the electrode material especially at the anodes, the acidic solutions are avoided for the water electrolysis. A typical water electrolysis cell is shown in Fig. 4.

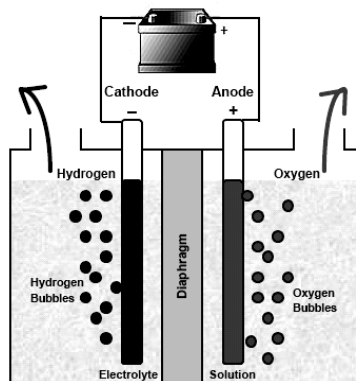
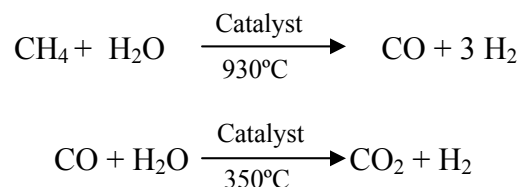

Fig.4. Typical water electrolysis cell

Electrolysis produces extremely pure hydrogen, which is necessary for some types of fuel cells. But a significant amount of electricity is required to produce a usable amount of hydrogen from electrolysis. In ideal case, this would come from renewable sources like wind and photo-catalysis. But the hydrogen produced from electrolysis will in no way help reduce the pollution of atmosphere if the electricity needed for the reaction is obtained through fossil fuels.

Steam-Methane Reformation

Hydrogen can also be extracted or "reformed" from natural gas. A two-step process at temperatures reaching 1100°C in the presence of a catalyst makes four parts hydrogen from one part methane and two parts water. It is a relatively efficient and inexpensive process, and can be made still more efficient with harvest of the waste heat (commonly referred to as cogeneration). This latter feature makes steam-methane particularly attractive for local use.



While this process is well understood and can be implemented on a wide scale today, it produces moderate emissions of carbon dioxide. Other innovative carbon-sequestration techniques are in development. Unlike renewable electrolysis, steam-methane reformation depends on fluctuating price of natural gas. Nonetheless, steam-methane reformation is poised to be the near-term hydrogen production method of choice on the road towards completely renewable methods.

Biomass Gasification

Hydrogen can be extracted from hydrogen-rich biomass sources like wood chips and agricultural waste. When heated in a controlled atmosphere, biomass converts to synthesis gas, which primarily consists of carbon monoxide (CO), carbon dioxide (CO₂), and hydrogen (H₂).

Gasification technology has been under intensive development over the last 2 decades. Large-scale demonstration facilities have been tested and commercial units are in operation worldwide. Fortunately, hurdles in biomass gasification have been economic rather than technical. Until recently, biomass gasification has been employed to produce low-value products like electricity or heat, which rarely justify the capital and operating costs. But the increasing demand for hydrogen promises to make biomass gasification economically viable in the near future.

Hydrogen from Coal

Vast coal resources have often been viewed, as a potential source against future energy needs. Unfortunately, coal mining pollutes and spoils the landscape, and burning coal produces many harmful emissions. Yet coal does contain hydrogen, and techniques are being developed to sequester the remaining carbon. These processes generally involve coal gasification to produce hydrogen and electricity, followed by re-injection of CO₂ or mineralization via carbonates.

Biochemical Hydrogen production

Life requires metabolism, a complex web of redox chemistry. This requires energy, which can be obtained by breaking of bonds (the multi-step breakdown of glucose to generate ATP and CO₂) or from electronic excitation. For example, plants, algae, cyanobacteria and photosynthetic bacteria can use light energy to raise electrons into higher energy states. In case of plants, algae and cyanobacteria, the source of excitable electrons is water. The excited electrons are stripped from water, which then splits into oxygen and protons.

Hydrogen is produced in micro-organisms by enzymes capable of reducing free protons to molecular hydrogen. Examples of these enzymes include hydrogenases and the nitrogenases. The production of hydrogen by these enzymes is usually coupled to some other biochemical processes. The energy used by these enzymes is usually in multiple steps from an organism's central energy inputs and is provided in the form of electron carriers such as ferredoxin or NADPH and energy yielding molecules like ATP. Obtaining useful amounts of hydrogen from microorganisms will require increasing the efficiency of hydrogenases and overcoming other obstacles. One problem is that some hydrogenases and nitrogenases are inhibited by oxygen. Oxygen is produced by photo-system II (PSII) during oxygenic photosynthesis.

In the summer of 2001, researchers manipulated the photosynthetic process of spinach plants to produce hydrogen. But these biological means of hydrogen production are known only as laboratory experiments. Intense research persists to better understand ways to improve these hydrogen production methods. Quantum leaps in this field could be the equivalent of striking oil. Biological hydrogen production is the most challenging area of biotechnology with respect to environmental problems. The future of biological hydrogen production depends not only on research advances, *i.e.* improvement in efficiency through genetically engineered microorganisms and/or the development of bioreactors, but also on economic considerations (the cost of fossil fuels), social acceptance, and the development of hydrogen energy systems.

Thermo-chemical decomposition of water:

The decomposition of water into hydrogen and oxygen can be achieved when energy is supplied in the form of heat and work. The positive value of ΔG^0 decreases with increase in temperature, but rather slowly because of the nearly constant enthalpy change, as a function of temperature and ΔG^0 becomes zero around 4700K. This means that even the highest temperature available from a nuclear reactor, in the range of 1300K, is not sufficient to decompose water. Therefore, single-step thermal decomposition of water is difficult unless other methods like electrolysis are resorted to. Two step decomposition

of water wherein a metal oxide, metal hydride or hydrogen halide is involved according to the equations:

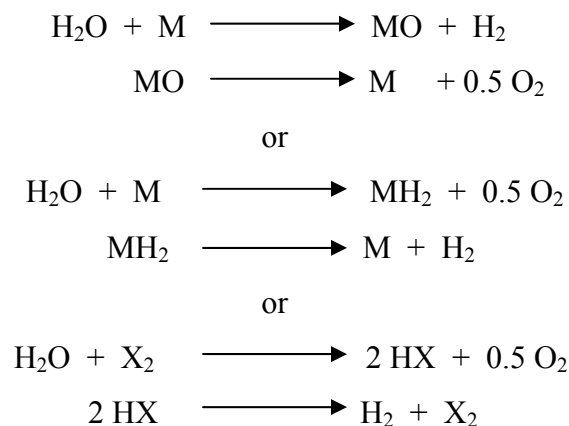

However, even these two-step routes require temperatures of the order of 1273 K or more. Water cannot be decomposed in one or two thermo-chemical steps when the available temperature is below 1273 K. However this can be done in a multiple-step process wherein each step is easy to accomplish with either a negative or a little positive ΔG for the reaction. For example if the desired reactions is

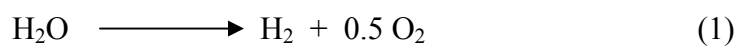

it can be achieved in a sequence of steps as follows:

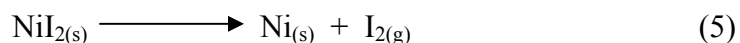
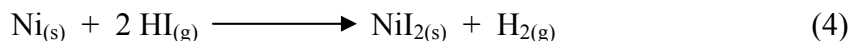
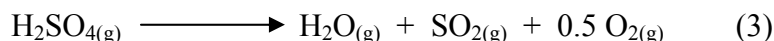
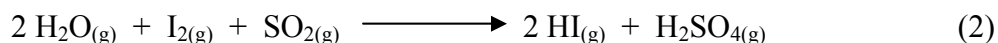

In this sequence the first reaction has a large positive ΔG (87.6 kJ/reaction) while all other reactions have negative ΔG values. Replacing step (1) by the following step will give a negative ΔG value.

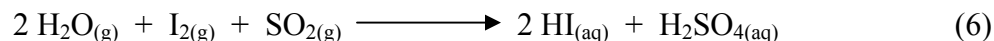

Carrying out the reaction in the four steps (Equations 2,3,4 and 5) at 300, 510, 570 and 1070K respectively requires -74.3 kJ. Therefore any thermochemical cycle can be chosen by incorporating the following four reaction steps : water decomposition or hydrolysis, hydrogen generation, oxygen generation, and the regeneration of any intermediates formed. Some other thermo-chemical cycles that are available for hydrogen generation are

- Mark 15 process (iron-halogen system)
- Mark 13 process (sulfur dioxide-iodine system)

Photochemical hydrogen production:

A photochemical hydrogen production is similar to a thermochemical system, in that it also employs a system of chemical reactants, which carry out the splitting of water. However, the driving force is not thermal energy but light, generally solar light. In this sense, this system is similar to the photosynthetic system present in green plants. One can effectively utilize photochemical means to promote endergonic (energy requiring) reactions. The sensitized oxidation of water by Ce^{4+} using irradiation of 254nm light by the following reaction is known.

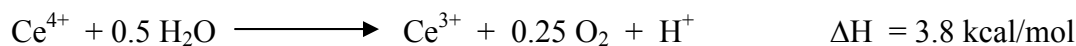

Ce^{3+} can be used with light of lower wavelength to promote the hydrogen generation reaction:



The quantum efficiency of these processes is very low. Similarly $\text{Ru}(\text{bpy})_3^{2+}$ and related complexes have relatively low excited-state lifetimes and can serve as electron donors or electron acceptors. A typical reaction is:

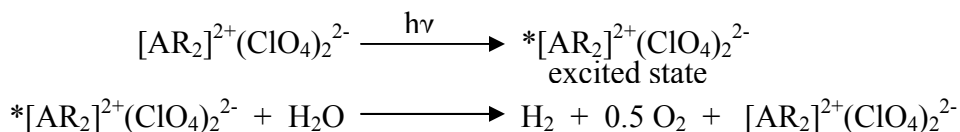

where $\text{R} = \text{C}_{18}\text{H}_{35}$ and $\text{A} = \text{Ruthenium bipyridyl complex}$

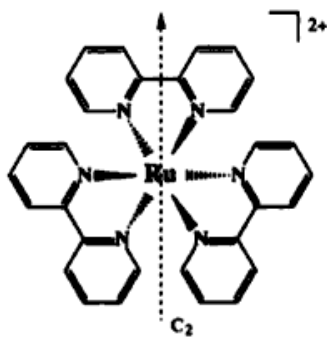

Fig.5. Ruthenium bipyridyl complex

Photoelectrochemical hydrogen production:

In its simplest form, a photoelectrochemical (PEC) hydrogen production cell consists of a semiconductor electrode and a metal counter electrode immersed in an aqueous electrolyte. When light is incident on the semiconductor electrode, it absorbs part of the light and generates electricity. This electricity is then used for the electrolysis of water.

Fujishima and Honda first demonstrated the electrolysis of water using solar energy in a PEC cell about 30 years ago. A schematic of their cell is shown in the Fig. 6.

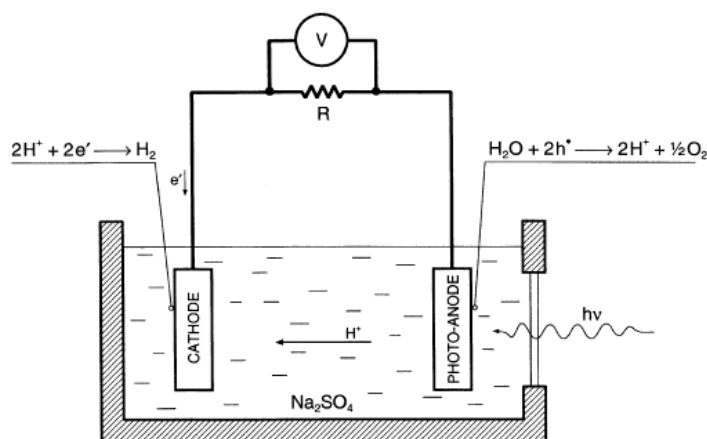
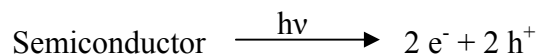

Fig.6. Schematic showing the structure of a PEC cell

As seen from the diagram, the cell consists of a semiconductor (TiO_2) photo-anode, which is irradiated with the UV-Visible radiation. The counter electrode is a metal. Following processes take place in the cell when light is incident on the semiconductor electrode:

1. Photo generation of charge carriers (electron and hole pairs)



2. Charge separation and migration of the holes to the interface between the semiconductor and the electrolyte and of electrons to the counter electrode through the external circuit. Now, holes are simply vacancies created in the valence band due to promotion of electrons from the valence band to the conduction band. However, in the study of electronic behavior of materials, "holes" are considered to be independent entities, with their own mass.

3. The holes move to the interface and react with water producing oxygen:

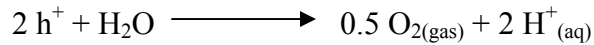

4. The electrons travel in the external circuit and arrive at the interface between the counter electrode (cathode) and electrolyte. There, they reduce the H^+ ions to H_2 :

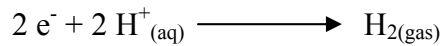

The complete reaction is absorption of photon and splitting of water into hydrogen and oxygen. The representation of the same process in band energy terms is shown in Fig. 7.

The cell depicted in Fig.7 is a single photoelectrode type cell, with the anode being the active photoelectrode. The lower band is the valence band of the n-type semiconductor, while the upper band is the conduction band. The energy difference between the top of valence band and the bottom of conduction band is termed as the band gap of semiconductor, E_g .

Some other configurations of the PEC cell are also possible:

1. The semiconducting material may be a p-type material. In this case, it will act as photo cathode, and reduction of H^+ ions to H_2 will take place at this electrode. The counter electrode may be a metal in this case.
2. Both electrodes, the cathode and anode, are photoactive semiconducting materials. In this case, the n-type electrode will act, as anode and favors oxidation of water to oxygen and H^+ will take place at this electrode. The p-type electrode will act as cathode, where H^+ ions will be reduced to H_2 .

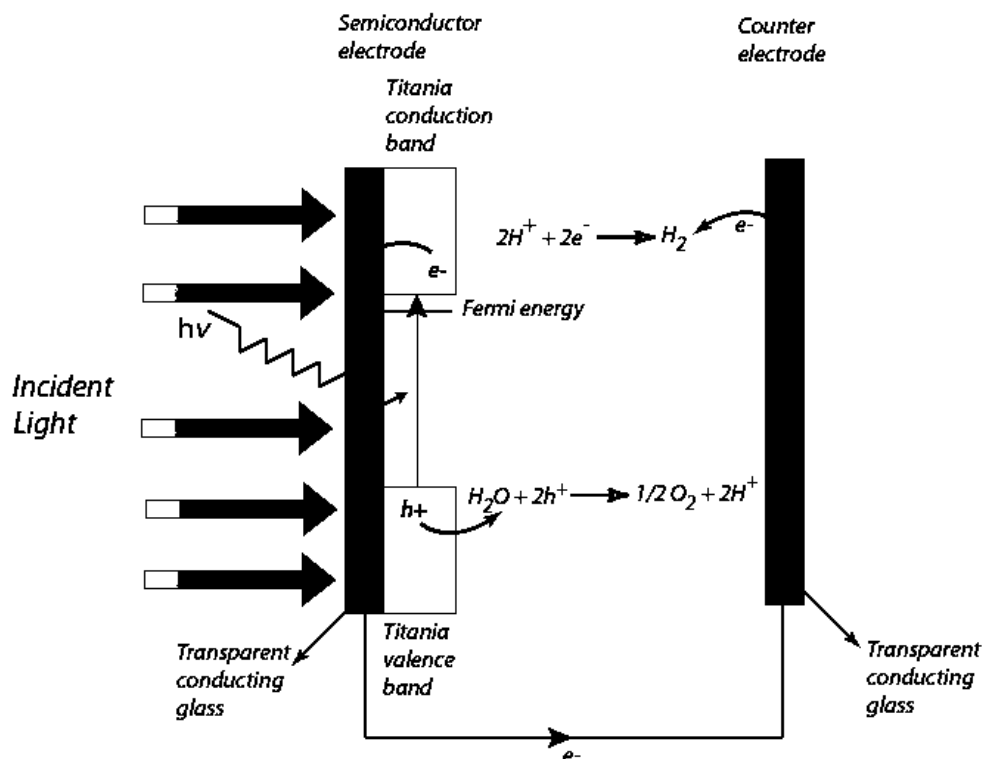

Fig.7. Operating principles of a photoelectrochemical cell

Photocatalytic hydrogen production:

Essentially the photocatalysed reactions have generated considerable interest after the photocatalytic splitting of water on TiO_2 electrodes was first demonstrated by Fujishima and Honda in 1972. Subsequently, various kinds of photocatalysts have been employed for hydrogen production and remediation of pollutants from water. Dispersed heterogeneous semiconductor surface provides a fixed environment that influences the chemical reactivity. Simultaneous oxidation and reduction reaction occurs on the surface of the catalyst on photoexcitation. The other advantages are, easy separation of catalyst after the reaction by centrifugation, availability of large surface area, low cost and stability.

In heterogeneous photocatalytic systems, absorption of the light is an essential requirement for successful photocatalysis. In addition, it should be stable at the reaction conditions employed and it should be chemically inert. Among the available materials like metals, semiconductors and insulators, the semiconductors have been used because

the band gap of semiconductor is optimum, band edge positions are suitable for oxidation/reduction of water and one can possibly use sunlight as energy source to excite the electron from the valence band.

In addition to the favorable band gap and band positions, semiconductors are inexpensive, non-toxic, easily recoverable and capable of retaining the catalytic activity. Also, loading of metal on the semiconductor surface and coupling of two semiconductors can increase the efficiency of the semiconductor photocatalysed reaction. Even though the light absorption is essential, other parameters like band gap, surface area, crystal phase, morphology, rate of interfacial charge transfer, carrier density and stability are also essential for the observed photocatalytic activity.

Photocatalysis involves the initial absorption of photons by a semiconductor to excite electrons from valence band to conduction band. This results in the formation of electron-hole pair within semiconductor. Excitation and redox processes taking place in semiconductor photocatalyst are shown in Fig. 8.

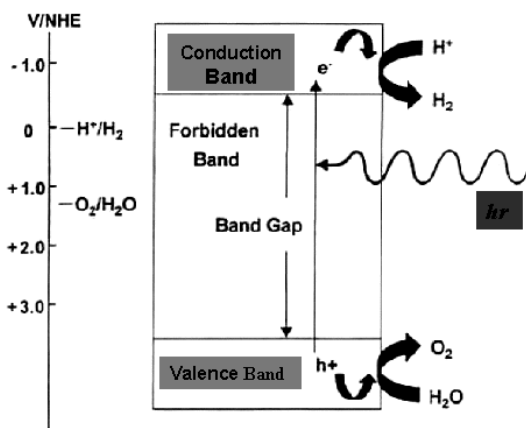

Fig.8. Excitation and redox reactions in semiconductor

For efficient photocatalytic reaction the electron-hole pair recombination must be suppressed. Either trapping the photogenerated electron or hole or both can lead to this. The electron in the conduction band moves to the surface and reduction reaction takes place either with adsorbed molecule or surface groups. Self-recombination with the hole in the valence band depresses the activity of the semiconductor.

The reduction and oxidation strength of the photoexcited electron and hole can be measured from the energy of the lower edge of the conduction band and upper edge of the valence band. Depending on the relative positions of the top of valence band, bottom of conduction band and the redox potentials of the species, the oxidation and reduction processes are promoted.

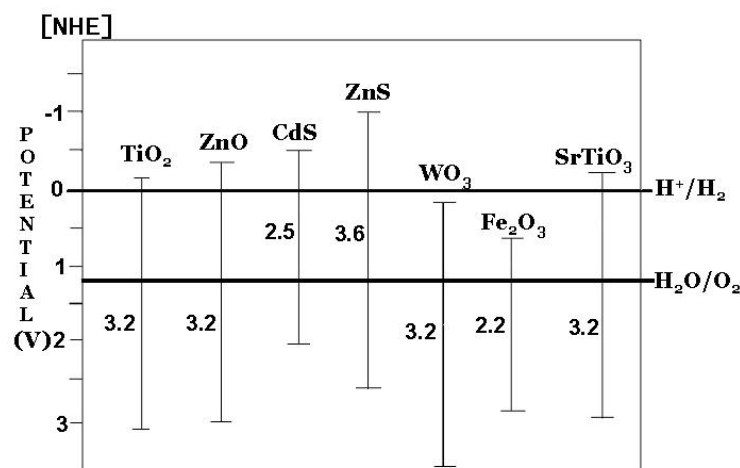

Fig. 9. Energy levels of various semiconductors

In general, the selection of semiconductor for a particular reaction is based on the position of the valence and conduction band edges and redox potential of the adsorbed species of interest, stability towards photocorrosion and the value of bandgap. Bandgaps and energy levels of various semiconductors are shown in Fig. 9. To reduce water, the potential of the bottom of conduction band must be more negative than the hydrogen reduction potential; for oxidation reaction, the top of valence band should be more positive than the oxidation potential of water; Energies of various semiconductors are shown in the Fig.9. with respect to normal hydrogen electrode (NHE).

Since the energy of valence and conduction levels of TiO₂ is optimum to oxidize most of the organic species, and its high oxidation ability of photogenerated holes ($E = 2.9\text{V}$ vs NHE at $\text{pH} = 0$) makes it as the best choice for photo-catalyst. In addition TiO₂ is inert, resistant to photocorrosion, thus making it as a good photo-catalyst. Among three structural modifications of TiO₂ (brookite, rutile and anatase), anatase is the form that is active. Even though there are other semiconductors to fulfill these criteria; some of them

suffer from “photocorrosion” under the experimental conditions employed. Fig. 10 shows the typical photocatalytic water splitting setup.

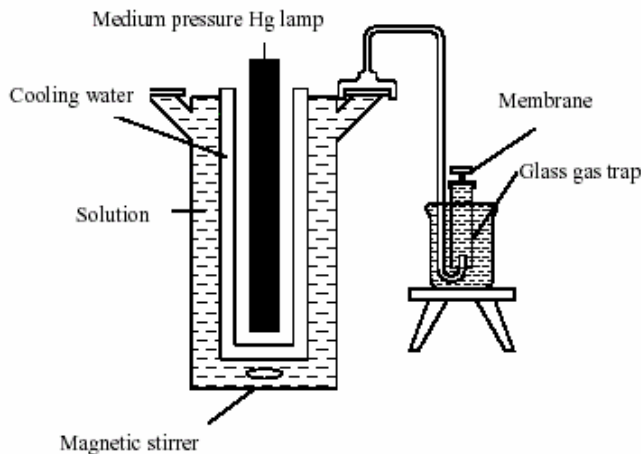

Fig.10. Photocatalytic water splitting setup

The major problem associated with photocatalytic splitting of water is the higher bandgap of the available semiconductor materials like TiO_2 . Because of the higher bandgap, these materials require UV light irradiation for carrying out the reaction whereas sunlight contains only 5% of UV radiation. The remaining part of the solar spectrum is composed mainly of visible and IR radiation. Research now focuses on reducing the bandgap of the available materials by various methods and finding new photoactive materials with lower bandgap.

Summary

Even though there are various methods available, the processes like direct electrolysis, steam methane reformation, biomass gasification, and hydrogen from coal and thermochemical decomposition they require other forms of energy like heat and/or electricity which can be obtained from fossil fuels or other expensive methods like nuclear energy. Also some of the methods lead to evolution of green house gases like carbon dioxide. Methods like photochemical hydrogen production have very less quantum efficiency.

Only the processes like photoelectrochemical, photocatalytic and biochemical hydrogen production have the potential to replace fossil fuels. For that an effective semiconductor photocatalyst, which has the desired bandgap, which absorbs light in the visible region, needs to be developed. The biochemical methods are highly sensitive to the environment and needs to be optimized for working under normal atmospheric conditions. Current research has shown more progress in this field and hopefully we will see some methods in future, which will produce hydrogen with completely renewable sources without any emission of polluting gases.

References

1. R. Narayanan, B. Viswanathan, "*Chemical and Electrochemical Energy Systems*", University Press, 1998.
2. www.rmi.org/sitepages/pid557.php
3. atom.ecn.purdue.edu/~vurade/PEC%20Generation%20of%20Hydrogen/Introduction%20to%20PEC%20hydrogen%20production.htm
4. www.fao.org/docrep/w7241e/w7241e00.htm#Contents
5. <http://web.mit.edu/~pweigele/www/being/content/how/bio.html>
6. Tokio Ohta, "*Solar-Hydrogen Energy Systems*", Pergamon Press, 1979

Chapter – 14

HYDROGEN STORAGE AND ECONOMY

M. Sankaran

1. Introduction

The fossil fuels in the form of coal, oil, and natural gas have powered the human society for few centuries. But continuing to power the world from fossil fuels threatens our energy supply and puts enormous strains on the environment. Unfortunately, forecasts for energy demands are not so encouraging, due to both the population growth rate and energy predictions of future consumption (Fig.1). Hence a new renewable energy system must be developed. These include solar energy, wind energy, tidal energy and nuclear energy. A major problem with several of the renewable energy source is that they are intermittent and their energy density is low. Thus, there is a need for an energy carrier that can act both as a storage and transportation medium to connect the energy source to the energy consumer.

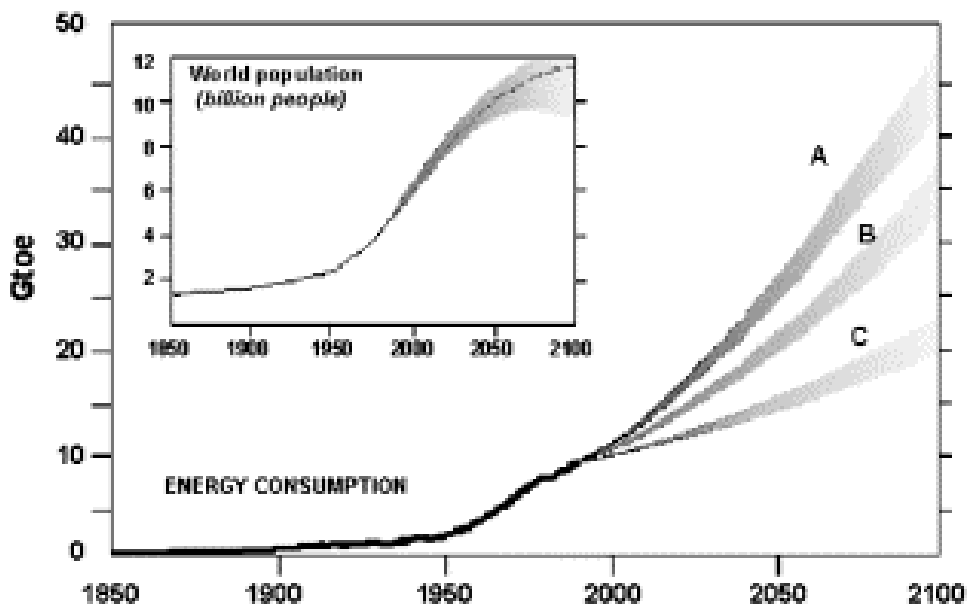

Fig.1. Scenarios for energy demand and population growth

One promising alternative to fossil fuels is hydrogen. Hydrogen is the cleanest, sustainable and renewable energy carrier. Although in many ways hydrogen is an attractive replacement for fossil fuels, it does not occur in nature as the fuel H_2 . Rather, it occurs in chemical compounds like water or hydrocarbons that must be chemically transformed to yield H_2 . At present, most of the world's hydrogen is produced from natural gas by a process called steam reforming. However, steam reforming does not reduce the use of fossil fuels but rather shifts them from end use to an earlier production step; and it still releases carbon to the environment in the form of CO_2 . Thus, to achieve the benefits of the hydrogen economy, we must ultimately produce hydrogen from non-fossil resources, such as water, using a renewable energy source. The other methods by which hydrogen produced are electrolysis of water, photochemical method and biochemical methods. But the major difficulty of utilizing hydrogen as fuel or energy carrier has been the absence of a practical means for hydrogen storage. The storage of hydrogen becomes the critical problem that the world faces today. Developing a high density hydrogen storage system is an essential one, which is above 6.5 wt% and that can release hydrogen at room temperature and atmospheric pressure, has been the focus and the goal of researchers for years. The gap between the present state of the art in hydrogen production, storage, and use and that needed for a competitive hydrogen economy is too wide to bridge in incremental advances.

2. Hydrogen storage options

Depending on storage size and application, several types of hydrogen storage systems may be available. This includes stationary large storage systems, stationary small storage systems at the distribution, or final user, level; mobile storage systems for transport and distribution including both large-capacity devices (such as a liquid hydrogen tanker – bulk carrier) and small systems (such as a gaseous or liquid hydrogen truck trailer); and vehicle tanks to store hydrogen used as fuel for road vehicles. Because of hydrogen's low density, its storage always requires relatively large volumes and is associated with either high pressures (thus requiring heavy vessels) or extremely low temperatures, and/or combination with other materials (much heavier than hydrogen itself).

Large underground hydrogen storage

Underground storage of hydrogen in caverns, aquifers, depleted petroleum and natural gas fields, and human-made caverns resulting from mining and other activities is likely to be technologically and economically feasible. Hydrogen storage systems of the same type and the same energy content will be more expensive by approximately a factor of three than natural gas storage systems, due to hydrogen's lower volumetric heating value.

Above-ground pressurized gas storage systems

Pressurized gas storage systems are used today in natural gas business in various sizes and pressure ranges from standard pressure cylinders (50 liters, 200 bar) to stationary high-pressure containers (over 200 bar) or low-pressure spherical containers (>30,000 m³, 12 to 16 bar). This application range will be similar for hydrogen storage.

Vehicular pressurized hydrogen tanks

Development of ultra-light but strong new composite materials has enabled storage of hydrogen in automobiles. Pressure vessels that allow hydrogen storage at pressures greater than 200 bars have been developed and used in automobiles. A storage density higher than 0.05 kg of hydrogen per 1 kg of total weight is easily achievable.

These options are viable for the stationary consumption of hydrogen in large plants that can accommodate large weights and volumes. Storage as liquid H₂ imposes severe energy costs because up to 40% of its energy content can be lost to liquefaction. The storage containers lose energy due the boil-off of hydrogen that is caused by thermal conductivity. The boil-off losses vary from 0.06 % per day of large containers to 3 % per day of small vessels. The boil-off losses can be reduced through proper insulation.

For transportation use, the onboard storage of hydrogen is a far more difficult challenge. Both weight and volume are at a premium, and sufficient fuel must be stored to make it practical to drive distances comparable to gas powered cars. Meeting the volume restrictions in cars or trucks, for instance, requires using hydrogen stored at densities higher than its liquid density. Fig.2. shows the volume density of hydrogen stored in several compounds and in some liquid hydrocarbons.

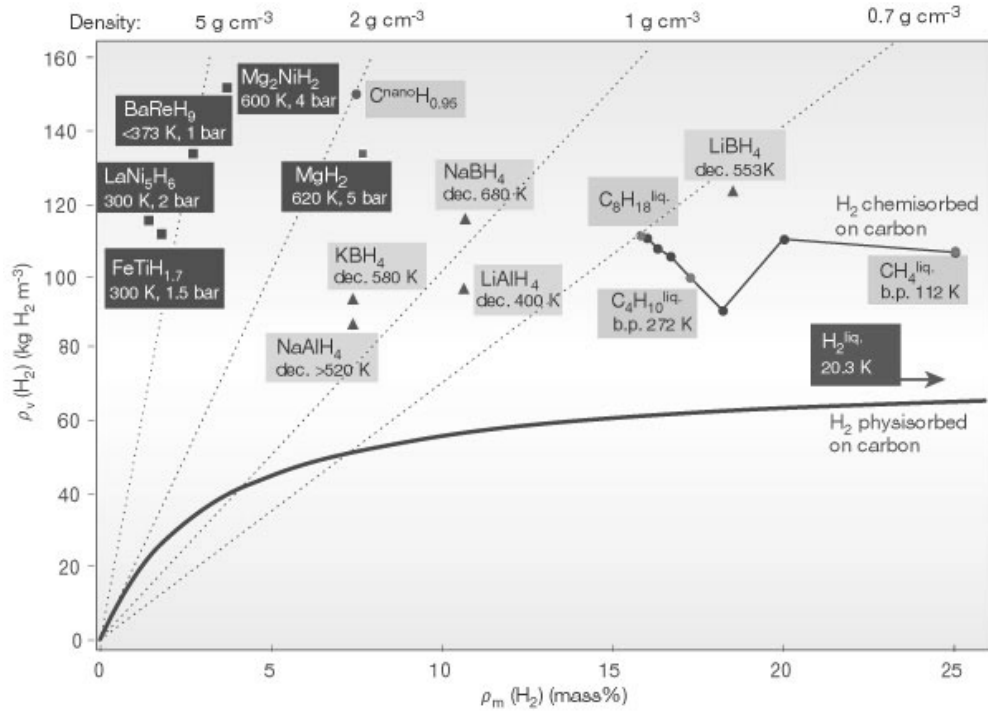

Fig.2. Stored hydrogen per mass and per volume (Comparison of metal hydrides, carbon nanotubes, petrol and other hydrocarbons).

The most effective storage media are located in the upper right quadrant of the figure, where hydrogen is combined with light elements like lithium, nitrogen, and carbon. The materials in that part of the plot have the highest mass fraction and volume density of hydrogen. Hydrocarbons like methanol and octane are notable as high volume density hydrogen storage compounds as well as high energy density fuels, and cycles that allow the fossil fuels to release and recapture their hydrogen are already in use in stationary chemical processing plants.

3. Metal Hydrides

Metal hydrides are composed of metal atoms that constitute of a host lattice and hydrogen atoms that are trapped in interstitial sites, such as lattice defects. The trap site can be a vacancy or a line defect. In the case of a line defect, a string of hydrogen atoms may accumulate along the defect. Such a string increases the lattice stress, especially if two adjacent atoms recombine to form molecular hydrogen. Since adsorption of hydrogen increases the size of lattices the metal is usually ground to a powder in order to prevent the decrepitation of metal particles. There are two possible ways of hydriding a metal,

direct dissociative chemisorption and electrochemical splitting of water. These reactions are, respectively

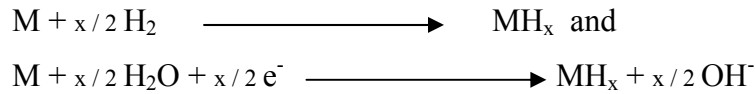

Where M represents the metal. In electrochemical splitting there has to be a catalyst, such as palladium, to break down the water.

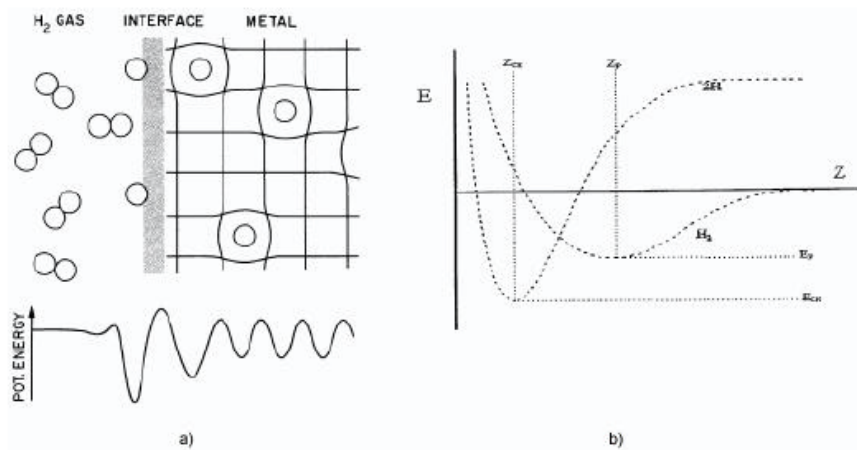

Fig.3. a) Schematic of hydrogen chemisorption on metal, b) Potential wells of molecular and atomic hydrogen

A schematic of hydrogen chemisorption is shown in Fig.3a. As shown in the figure, the molecular hydrogen reaches a shallow potential minimum near the surface and the atomic hydrogen a deeper minimum almost at the surface. In the metal lattice hydrogen has periodic potential minimums in the interstitial sites of metal lattice. This behavior is explained below and is visualized in Fig.3b. As a hydrogen molecule approaches the metal surface, weak van der Waal's forces begin to act upon it drawing it closer. The molecule reaches the potential well E_p at distance z_p , and very large forces would be required to force it any closer the surface in a molecular form. However, the dissociation energy of hydrogen molecule is exceeded by the chemisorption energy. Thus the hydrogen molecule dissociates and individual hydrogen atoms are attracted to the surface by chemisorptive forces and they reach the potential well E_{CH} . From this point sometimes even the ambient temperature's thermal energy is enough to increase the

vibrational amplitude of hydrogen atoms which can thus reach and enter the metal surface.

Metal and hydrogen usually form two different kinds of hydrides, α -phase and β -phase hydride. In α -phase there is only some hydrogen adsorbed and in β -phase the hydride is fully formed. For example, Mg_2Ni forms hydrides of $\text{Mg}_2\text{NiH}_{0.3}$ and Mg_2NiH_4 . When initially charged the hydride gets to the α -phase and after that when charged and discharged the hydride usually undergoes the phase transformation such as

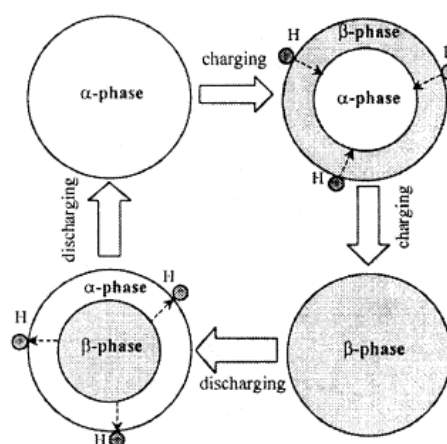
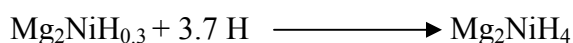

Fig.4. Schematic of phase transition in metal hydride

A schematic of phase transition is presented in Fig.4. When charging, hydrogen diffuses from the surface of the particle through the β -phase to the phase-transition interface and forms additional β -phase hydride. When discharging, hydrogen from the phase-transition interface diffuses through the α -phase to the surface of the particle where it is recombined into the form of molecular hydrogen. A study of nano-scaled particles shows that when the metal grains are in the range of 5 to 50 nm, the kinetics of both absorption and desorption is improved by an order of magnitude because of improved thermal conductivity. The kinetics can also be improved with a catalyst. These catalysts can be in liquid or solid form, but because the catalyst does not affect the overall reaction, its

amount should be kept as low as possible in order to keep the storage capacity sufficient. In Fig.5. the effects of the nanostructure and catalyst on the hydrogen adsorption of LaNi_5 is shown.

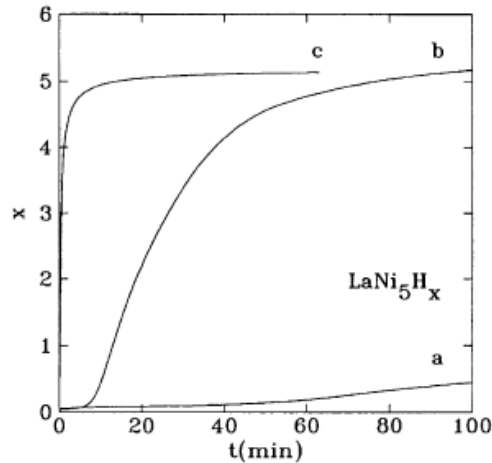

Fig.5. Rate of hydrogen adsorption by LaNi_5 . a) Polycrystalline, b) Nano-crystalline, c) Nanocrystalline with catalyst

The most common characterization method of a metal hydride is the PCT (pressure – concentration – temperature) curve in a form of $P - C$ isotherms. A theoretical $P - C$ isotherm with α - and β -phases is shown in Figure 5. The concentration, i.e. the hydrogen capacity, is usually defined as hydrogen atoms per metal molecule H/M . In order to characterize the metal hydride it is convenient to use the maximum hydrogen capacity $(H/M)_{max}$. The reversible capacity $\Delta(H/M)$, defined as the plateau width, is also a useful tool when considering the engineering capacities of metal hydrides.

The thermodynamic reaction equilibrium is defined with the equilibrium constant K

$$RT \ln K = \Delta H - T\Delta S$$

Where ΔH is the reaction enthalpy and ΔS the reaction entropy. For a solid-gas reaction the equilibrium constant reduces to the pressure of the gas. Thus the van't Hoff equation is obtained

$$\ln P = \Delta H / RT - \Delta S / R$$

Plotting the equilibrium (P, T) -values on $\ln P$ versus $1/T$ scale gives the van't Hoff plot. The reaction enthalpy can be derived from the angular coefficient of the plot with the help of Equation and the plot tells the suitability of $P - T$ behavior of a hydride for

practical applications. The theoretical van't Hoff plot usually describes very well the real properties of metal hydrides.

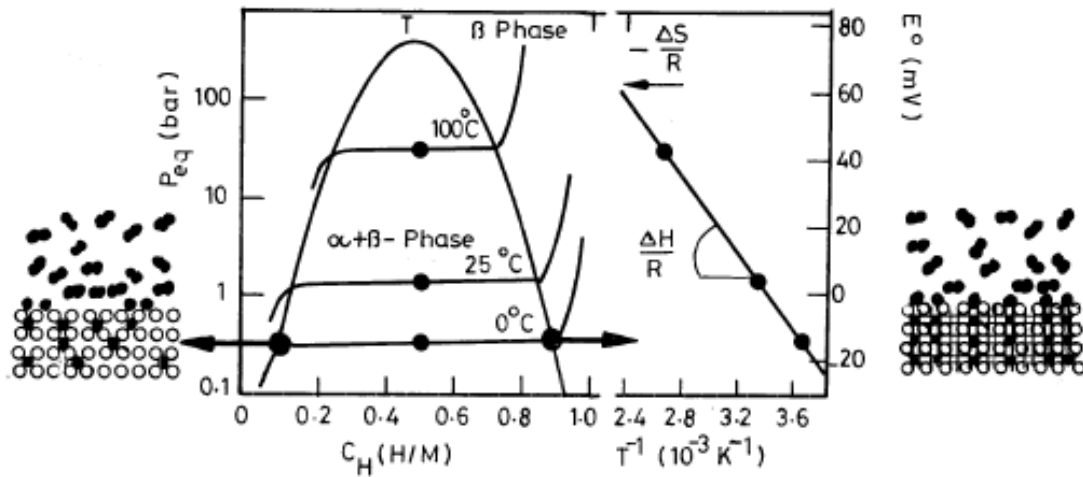

Fig.6. Pressure composition isotherms for hydrogen absorption in a typical metal hydride. In the Figure the solid solution (α -phase), the hydride phase (β -phase) and the region of the co-existence of the two phases are shown. The co-existence region is characterized by the flat plateau and ends at the critical temperature T_c . The construction of the van't Hoff plot is shown on the right hand side. The slope of the line is equal to the enthalpy of formation divided by the gas constant and the intercept is equal to the entropy of formation divided by the gas constant

The reaction enthalpy of hydride formation is an important quantity. It is usually negative so the reaction is exothermic and thus the hydride formation releases energy. Therefore the dehydration needs energy to be able to take place. Since most of the applications are used in ambient temperature, or at least in the range of 0 – 100 °C, the reaction enthalpy should be quite small so that the hydride could take heat from the surroundings when releasing hydrogen. In some fuel cell systems the hydride can take heat directly from the fuel cell. The reaction enthalpy also affects directly the stability of a hydride since the gas pressure is exponentially proportional to it. The essential requirements that should be satisfied by metal hydrides proposed for hydrogen storage at a commercial level. These are summarized below.

- High hydrogen content
- Facile reversibility of formation and decomposition reactions. The hydride should be decomposable at moderate temperatures that can be provided from locally available heat sources, like solar, automobile exhaust and waste heat sources

- Absorption-desorption kinetics should be compatible with the charge-discharge requirements of the system
- The equilibrium dissociation pressure of the hydride at peak desorption rate should be compatible with the safety requirements of the hydride containment system. The hydride itself should have a high safety factor
- The hydride should have a sufficient chemical and dimensional stability to permit its being unchanged over a large number of charge–discharge cycles
- Minimal hysteresis in adsorption–desorption isotherms
- The hydride should be reasonably resistant to deactivation by low concentrations of common (sometimes unavoidable) contaminants such as O₂, H₂O, CO₂, CO, and others
- The total cost of hydride (raw materials, processing and production) should be affordable for the intended application. The long term availability of raw materials (that is, the metal resources), must be ensured. The cost of the hydride system (which includes its containment) per unit of reversibly stored hydrogen should be as low as possible
- The storage vessel and ancillary equipment cost and the fabrication and installation costs should be moderate
- Operating and maintenance costs and purchased energy requirements (that is, energy other than waste energy and energy extracted from the ambient air) per storage cycle should be low.

Table 1. Hydrogen Storage capacity of metallic and intermetallic systems.

Material	P _{des} (atm)	T(K)	H-atoms/ cm ³ (x10 ²²)	Weight % of hydrogen
MgH ₂	~10 ⁻⁶	552	6.5	7.6
Mg ₂ NiH ₄	~10 ⁻⁵	528	5.9	3.6
FeTiH ₂	4.1	265	6.0	1.89
LaNi ₅ H ₆	1.8	285	5.5	1.37

A judicious combination of technical and economic considerations will determine the suitability of a hydride product for a given hydrogen storage or hydrogen containment application. Hydrogen storage capacity of some of the metal and intermetallics are given in Table 1.

Metal hydrides are very effective at storing large amounts of hydrogen in a safe and compact way. All the reversible hydrides working around ambient temperature and atmospheric pressure consist of transition metals; therefore, the gravimetric hydrogen density is limited to less than 3 mass%. It remains a challenge to explore the properties of the lightweight metal hydrides.

4. Hydride Complexes

Certain transition metals form a hydride with some elements from the periodic table groups IA and IIA when hydrogen is present. The transition metal stabilizes the complex of hydrogen. For example, Mg_2NiH_4 is formed when Mg donates two electrons to the $[\text{NiH}_4]^{-4}$ complex. The kinetics of hydride complexes tends to be slower compared to the traditional interstitial hydrides since the formation and decomposition of the hydride complex requires some metal atom diffusion. Hydrogen desorption also needs usually quite high temperatures (over 150 °C). Despite these disadvantages the high hydrogen capacity makes these materials potential for hydrogen storage. For example, the maximum capacity of Mg_2FeH_6 is 5.5 wt%. Also some non-transition metals form complex hydrides. These includes, for example, reversible two-step reaction of NaAlH_4

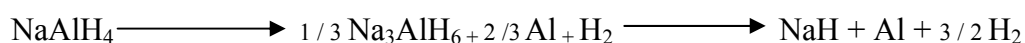

The maximum hydrogen capacity of this reaction is 5.6 wt%. When catalyzed with a small amount of some liquid alkoxides the hydrogen pressure of 1 atm was obtained at 33 °C. The cyclic stability of reversible capacity was however very poor because the catalysts brought impurities into the hydride. The latest studies show that with some inorganic catalysts almost the theoretical reversible capacity of 5.6 wt% may be achieved.

5. Hydrogen in Carbon Structures

Hydrogen can be stored into the nanotubes by chemisorption or physisorption. The methods of trapping hydrogen are not known very accurately but density functional calculations have shown some insights into the mechanisms. Calculations indicate that hydrogen can be adsorbed at the exterior of the tube wall by H-C bonds with a H/C

coverage 1.0 or inside the tube by H-H bonds with a coverage up to 2.4 as shown in Figure 7. The adsorption into the interior wall of the tube is also possible but not stable. The hydrogen relaxes inside the tube forming H-H bonds. The numbers in the figure tell the bond lengths in 10^{-10} m.

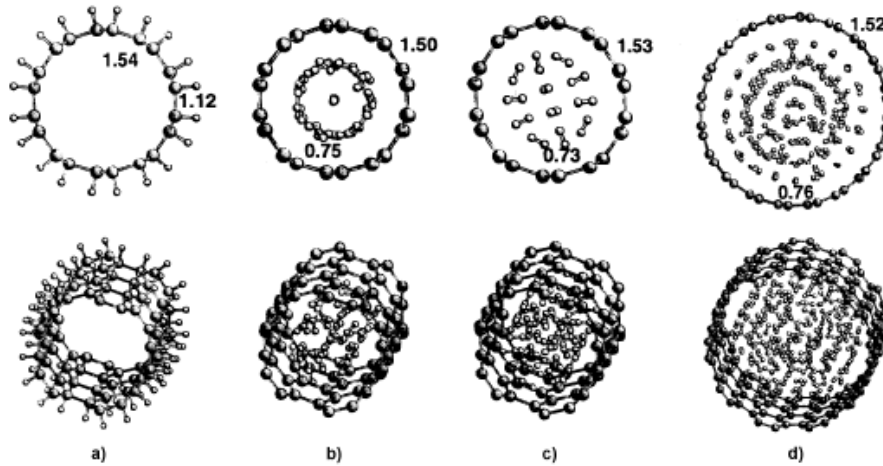

Fig.7. Hydrogen adsorption in a nanotube. a) exterior adsorption with H/C coverage 1.0, b) interior adsorption with coverage 1.0, c) interior adsorption with coverage 1.2, d) interior adsorption with coverage 2.4

Multi-walled nanotubes, in which two or more single tubes are rounded up each other with van der Waal's attraction, can adsorb hydrogen between the single-wall nanotubes. The hydrogen causes the radius of the tubes to increase and thus makes a multi-walled nanotube less stable. In nanotube bundles hydrogen can also be adsorbed in the middle of different tubes. The density functional calculations have shown that theoretically in proper conditions a single-walled nanotube can adsorb over 14 wt% and a multi-walled nanotube about 7.7 wt% of hydrogen. Dillon et al. reported the first experimental result of high hydrogen uptake by a nanotube. They estimated that hydrogen could achieve a density of 5 – 10 wt%. Chen et al. reported that alkali doped nanotubes are able to store even 20 wt% under ambient pressure, but are unstable or require elevated temperatures. The result has shown to be in a great disagreement with other results and has been thought to be incorrect.

Recent results on hydrogen uptake of single-walled nanotubes are promising. At 0.67 bar and 600 K about 7 wt% of hydrogen have been adsorbed and desorbed with a good cycling stability. Another result at ambient temperature and pressure shows that 3.3 wt%

can be adsorbed and desorbed reproducibly and 4.2 wt% with a slight heating. The price of commercial nanotubes is quite high. Even though the price of the nanotubes is still high they have a good potential in storing hydrogen. When the manufacturing techniques are improved and some engineering problems solved, they may be highly competitive against other hydrogen storage technologies.

Other Forms of Carbon

There are also some other forms of carbon that adsorb hydrogen. These are graphite nanofibers, fullerenes, and activated carbon. All the three of these are briefly discussed.

5.1 Graphite Nanofibers

Graphite nanofibers are graphite sheets perfectly arranged in a parallel ('platelet' structure), perpendicular ('tubular' structure), or at angle orientation ('herringbone' structure) with respect to the fiber axis. A schematic of the structure of a nanofiber with some hydrogen adsorbed between the sheets is represented in Fig.8.

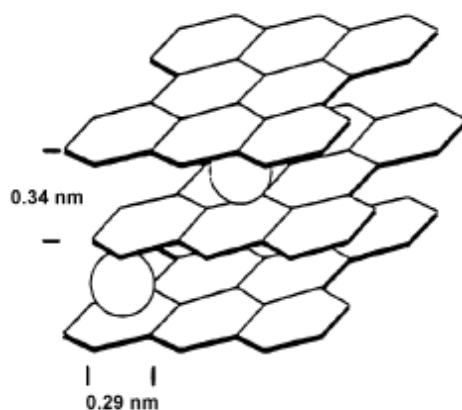

Fig.8. Schematic of graphite nanofiber with hydrogen adsorbed

The most critical factor affecting the hydrogen adsorption of nanofibers is the demand for high surface area since the hydrogen is adsorbed in the middle of the graphite sheets. Rodriguez et al. has reported that some nanofibers can adsorb over 40 – 65 wt% of hydrogen. However, these results have been criticized and have not been able to be reproduced. Studies have shown only about 0.7 – 1.5 wt% of hydrogen adsorbed in a nanofiber under ambient temperature and pressures slightly above 100 bar. Some other studies claim that about 10 – 15 wt% of hydrogen have been adsorbed in graphitic and

non-graphitic carbon nanofibers. The cyclic stability and other properties of nanofibers are not really studied yet and thus it is difficult to say whether the nanofibers will be competitive against other hydrogen storage technologies or not.

5.2 Fullerenes

Fullerenes are synthesized carbon molecules usually shaped like a football, such as C_{60} and C_{70} . Fullerenes are able to hydrogenate through the reaction.

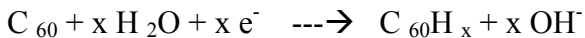

According to theoretical calculations the most stable of these are $C_{60}H_{24}$, $C_{60}H_{36}$, and $C_{60}H_{48}$, latter of which is equal to 6.3 wt% of hydrogen adsorbed. An experimental study made by Chen et al. shows that more than 6 wt% of hydrogen can be adsorbed on fullerenes at 180 °C and at about 25 bar. Usually the bonds between C and H atoms are so strong that temperatures over 400 °C are needed to desorb the hydrogen [40], but Chen et al. were able to do this at a temperature below 225 °C. Despite the quite high hydrogen storing ability, the cyclic tests of fullerenes have shown poor properties of storing hydrogen.

5.3 Activated Carbon

Bulky carbon with high surface area, so-called activated carbon, is able to adsorb hydrogen in its macroscopic pores. The main problems are that only some of the pores are small enough to catch the hydrogen atom and that high pressure must be applied in order to get the hydrogen into the pore. About 5.2 wt% of hydrogen adsorbed into the activated carbon has been achieved at cryogenic temperatures and in pressures of about 45 – 60 bar. In ambient temperature and pressure of 60 bar the figure has been only approximately 0.5 wt%. Some studies show that a combination of carbon-adsorbent in a pressure vessel can adsorb little more hydrogen than what would fit into an empty vessel as gas. This is true for pressures below about 150 bar after which an empty vessel can store more hydrogen. The poor P – T properties for hydrogen sorption of activated carbon prevents them from being suitable hydrogen storage in practical applications.

6. Zeolites

Zeolites are microporous inorganic compounds with an effective pore size of about 0.3 – 1.0 nm. The pore size is sufficient to permit the diffusion of some small molecules, such

as hydrogen, under elevated temperatures and pressures. However, most of the pores are smaller than the kinetic size of a hydrogen molecule in ambient temperature. Thus reducing the temperature the hydrogen is trapped into the cavities of the molecular sieve host. Zeolites have structures based on TO_4 tetrahedra, where T is a silicon or aluminum atom. Depending on the structure, Si / Al – ratio, and substituting atoms, such as Na, K, and Pd, the zeolites are named as zeolite A, X, Y, or mordenites etc. An example of the pore structure (big holes) of zeolites is given in Fig.9.

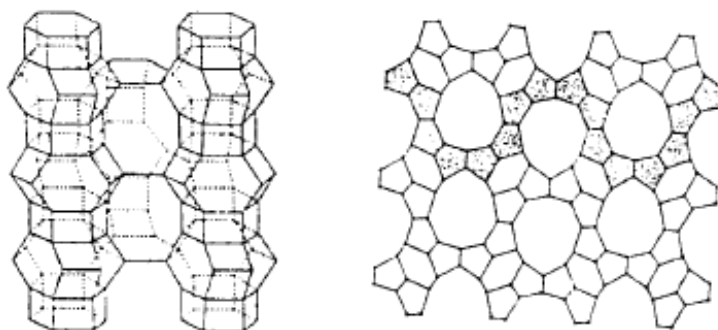

Fig.9. Pore structure of zeolites, a) Side view, b) Top view

The hydrogen storage capacity of zeolites is quite poor. At temperatures of 200 – 300°C and pressures of about 100 – 600 bar about 0.1 – 0.8 wt% of hydrogen is adsorbed. The cyclic stability of zeolites has not been really studied. Ernst et al. suggested that by applying sophisticated techniques of synthesis and modification there may exist a potential in zeolites. However, this is yet to be seen.

7. Glass Spheres

Glass spheres are small hollow glass micro-balloons whose diameter vary from about 25 mm to 500 mm and whose wall thickness is about 1 mm. The spheres are filled with hydrogen at high pressure and temperature of 200 – 400 °C. High temperature makes the glass wall permeable and the hydrogen is able to fill in. Once the glass is cooled down to ambient temperature, the hydrogen is trapped inside the spheres. The hydrogen can be released by heating or crushing the spheres. The crushing naturally prevents the reuse of spheres and is not necessarily a very favorable option. The glass spheres can also cause

accidents when breaking down if not handled properly. The storage capacity of spheres is about 5 – 6 wt% at 200 – 490 bar.

8. Chemical Storage

Chemical compounds containing hydrogen can also be considered as a kind of hydrogen storage. These include e.g. methanol CH_2OH , ammonia NH_3 , and methylcyclohexane $\text{CH}_3\text{C}_6\text{H}_{12}$. In STP condition all of these compounds are in liquid form and thus the infrastructure for gasoline could be used for transportation and storage of the compounds. This is a clear advantage compared to gaseous hydrogen, which demands leak-proof, preferably seamless, piping and vessels. The hydrogen storage capacity of these chemical compounds is quite good – 8.9 wt% for CH_2OH , 15.1 wt% for NH_3 , and 13.2 wt% for $\text{CH}_3\text{C}_6\text{H}_{12}$. These figures do not include the containers in which the liquids are stored. Because the containers can be made of light-weighted composites or even plastic in some cases, the effect of a container is negligible especially with larger systems.

Chemical storage of hydrogen has also some disadvantages. The storage method is non-reversible, i.e. the compounds cannot be “charged” with hydrogen reproducibly. The compounds must be produced in a centralized plant and the reaction products have to be recycled somehow. This is difficult especially with ammonia, which produces highly pollutant and environmentally unfavorable nitrogen oxides. Other compounds produce carbon oxides, which are also quite unfavorable.

9. Summary of Hydrogen Storage Technologies

The hydrogen storage capacities of different storage methods in weight per cents and corresponding hydrogen energy capacities in kWh/kg are gathered in Table. The capacities shown in the table are the maximum values that are experimentally achieved. For metal hydrides and nanotubes, the lower values are in practical conditions and greater the maximum values in elevated temperatures and / or pressures. Also some possible application areas for different storage methods are gathered in Table. These are portable (PO), transportation (TR), and power production (CHP), and are discussed in the next chapter. There is no specific application area marked for activated carbon, zeolites, or glass spheres because of the unpractical operating conditions or poor hydrogen storage capacity. Some special applications, in which high temperatures and pressures are used,

may exist for activated carbon and glass spheres. Carbon nanostructures are thought to have potential for portable and transportation applications in the future.

Table 2. Hydrogen capacities of different storage methods

Storage method	Hydrogen capacity (Wt %)	Energy capacity (KW/Kg)	Possible application areas
Gaseous H ₂	11.3	6.0	TR [*] , CHP
Liquid H ₂	25.9	13.8	TR
Metal hydrides	~2-6.6	0.8-2.3	PO ^{**} , TR
Activated carbon	6.2	2.2	-
Zeolites	0.8	0.8	-
Glass spheres	8	2.6	-
Nanotubes	4.2-7	1.7-3.0	PO, TR
Fullerenes	~8	2.5	PO, TR
Chemical	8.9-15.1	3.8-7.0	All

*TR – Transport

**PO – Portable applications

10. Hydrogen economy

It may be that Hydrogen economy has the potential of being a reality but all the three stages of hydrogen economy namely hydrogen production, storage and transportation infrastructure are still in the initial stages of development and certainly need considerable scientific input. The realization of this hydrogen economy largely depends on the cooperation between the scientists for the development of new materials and technologists to design appropriate devices and reactors so that this alternate form of energy source can be utilized by mankind. A comprehensive delivery infrastructure for hydrogen faces many scientific, engineering, environmental, safety and market challenges.

The public acceptance of hydrogen depends not only on its practical and commercial appeal, but also on its record of safety in widespread use. The flammability, buoyancy, and permeability of hydrogen present challenges to its safe use. These properties are different from, but not necessarily more difficult than, those of other energy carriers. Key

to public acceptance of hydrogen is the development of safety standards and practices that are widely known and routinely used like those for self service gasoline stations or plug in electrical appliances. The technical and educational components of this aspect of the hydrogen economy need careful attention. Achieving these technological milestones, while satisfying the market discipline of competitive cost, performance, and reliability, requires technical breakthroughs that come only from basic research.

Cooperation among nations to leverage resources and create innovative technical and organizational approaches to the hydrogen economy is likely to significantly enhance the effectiveness of any nation that would otherwise act alone. The emphasis of the hydrogen research agenda varies with country; communication and cooperation to share research plans and results are essential.

11. Economics and development patterns

The development of hydrogen storage device is the critical component:

Table 3. Summary of the hydrogen storage costs for stationary applications

Storage System / Size (GJ)	Specific TCI (\$/GJ_{capacity})	Storage Cost (\$/GJ)
Compressed Gas		
Short term (1-3 days)		
131	9,008	4.21
147	16,600	33.00
13,100	2,992	1.99
20,300	2,285	1.84
130,600	1,726	1.53
Long term (30 days)		
3,900	3,235	36.93
391,900	1,028	12.34
3,919,000	580	7.35
Liquefied Hydrogen		
Short term (1-3 days)		
131	35,649	17.12
13,100	7,200	6.68

20,300	1,827	5.13
130,600	3,235	5.26
Long term (30 days)		
3,900	1,687	22.81
108,000	1,055	25.34
391,900	363	8.09
3,919,000	169	5.93
Metal Hydride		
Short term (1-3)		
131-130,600	4,191-18,372,	2.89-7.46
Long term (30 days)		
3,900-3.9 million	18,372	205.31
Cryogenic Carbon (1 day)	4,270	26.63
Underground (1-day)	7-1,679	1.00-5.00

Carbon nanostructure systems are expected to have significantly reduced costs because there is no cryogenic requirement, but the technology is still in the early development stages and so costs have not yet been developed. Currently, there are no commercial applications of carbon-based hydrogen storage. However, researchers are continuing to look into increasing the gravimetric capacity of these systems and to improve the overall system engineering.

12. Forecasting

Essentially the challenges that have to be faced in the development of suitable hydrogen storage medium are:

- Reducing the cost of production of hydrogen storage medium like carbon nanotubes using economical methods.
- The existing demand prohibits development of high storage capacity facilities.
- The simultaneous utilization of storage medium as electrode as well the hydrogen storage medium, by then the hydrogen released can be effectively utilized.
- High storage capacity of hydrogen by any of the possible methods needs considerable development of the relevant technology.

13. Global demands and infrastructure

Demand for alternative energy increase as increase in the energy requirement. The drawback of utilizing hydrogen as the alternative fuel is mainly due to the absence of the appropriate storage medium.

- The challenges and demand faced for the storage of hydrogen can be surmounted if the following aspects are addressed
- Investigation and development of new materials for the storage of hydrogen.
- One has to develop suitable and reproducible experimental techniques to identify the storage capacity.
- International / National awareness should be increased in both hydrogen based technology and the possibility of developing such technology.
- The existing storage medium can be improved considerably and the cost and size of the storage medium can also be reduced.
- Steps towards hydrogen economy
- The steps towards the hydrogen-based economy must include the following:
 - The hydrogen-based economy will and can reduce our dependence on fossil fuels and also tilt our economy from the anxiety over foreign exchange reserve.
 - It will have considerable environmental acceptance and also reduce the strain the country is facing today in some major cities.
 - There must be governmental and non-governmental will power to initiate, implement and sustain the programme, overcoming the teething issues that may arise out of this transition.
 - Enough resources have to be generated and utilized in a profitable and also non-wasteful manner in order to achieve the objectives

In order to realize this vision for a hydrogen based economy, the country needs a national road map for hydrogen energy comprising in total all the aspects of hydrogen energy as outlined above and also the social acceptance and adaptation.

14. Recommendations:

Skills of all nature are required for such a development and it is essential the following aspects be immediately considered.

- Development of highly efficient storage medium

- Development of cost effective materials with considerable cycles life time
- Development of suitable engineering design and also the subsequent power converters.
- Principles for production, materials for storage and also the necessary infra structure.
- The policies governing energy, environmental concerns, utility regulations, business opportunities, the moral and social codes and practices and the standards of living we expect are the critical elements of an appropriate infra structure in which the Hydrogen energy based economy can develop.

The participating organizations, namely government, industry, academic and research institutions, environmental agencies should work together with zeal to execute the top priority actions and recommendations in the true spirit of participation and cooperation.

References

1. Christmann K., Hydrogen Adsorption on Metal Surfaces. In: Atomistics of Fracture Conference Proceedings, Eds. Latanision and Pickensr, Plenum, NY, USA 1981
2. Sandrock G., A Panoramic Overview of Hydrogen Storage Alloys from a Gas Reaction Point of View, J. Alloys and Compounds, Vol. 293-295, pp. 877- 888, 1999
3. Lee S., Lee Y., Hydrogen Storage in Single-Walled Carbon Nanotubes, Applied Physics Letters, Vol. 76, No. 20, pp. 2877-2899, 2000
4. J. Bockris, Hydrogen economy in the future, International Journal of Hydrogen Energy 24 (1999), pp. 1–15.
5. Maria H. Maack and Jon Bjorn Skulason, Implementing the hydrogen economy Journal of Cleaner Production Volume 14, Issue 1 , 2006, Pages 52- 64.

Chapter – 15

BIOCHEMICAL ENERGY CONVERSION PROCESSES

C. M. Janet

1. Introduction

As we have assimilated almost all of the available options for the energy production, conversion and utility, it is the right time for us to evaluate and understand how all these energy conversion processes are significant over one or the other and how the disparity in all can be perceived and corrected taking the principles of nature. Even though petroleum, petrochemicals, coal, fossil fuels are efficient, the amount of hazardous byproducts released to the atmosphere is a matter of concern. Nuclear energy seems to be promising and attractive, but having the control over the process to provide enough security and safety appear to be cumbersome. And about extracting the solar power for energy production by means of photovoltaic and photoelectrochemical cells has not reached to the extent that the common man can access it cheaply. Hence it is appropriate to go for nature's principles for the production and processing of energy. Biochemical processes are having many advantages such as

1. No unwanted and hazardous by-products are formed.
2. Occurs at normal temperatures and pressures
3. No special equipments are needed.
4. All are renewable energy sources
5. Eco friendly process

Green chemistry offers cleaner processes for energy abatement. Some of such energy conversion processes are

1. Photosynthesis
2. Glycolysis
3. Nitrogen fixation
4. Fermentation processes

2. Photosynthesis

Although some of the steps in photosynthesis are still not completely understood, the overall photosynthetic reaction has been known since the 1800s. Jan van Helmont began the research

of the process in the mid-1600s when he carefully measured the mass of the soil used by a plant and the mass of the plant as it grew. After noticing that the soil mass changed very little, he hypothesized that the mass of the growing plant must come from the water, the only substance he added to the potted plant. This was a partially accurate hypothesis - much of the gained mass also comes from carbon dioxide as well as water. However, this was a point to the idea that the bulk of a plant's biomass comes from the inputs of photosynthesis, not the soil itself. Photosynthesis is an important biochemical process in which plants, algae, and some bacteria harness the energy of sunlight to produce food. Ultimately, nearly all living things depend on energy produced from photosynthesis for their nourishment, making it vital to life on earth. It is also responsible for producing the oxygen that makes up a large portion of the earth's atmosphere. Organisms that produce energy through photosynthesis are called photoautotrophs. Half of all photosynthesis comes not from plants, but from bacteria and algae. It is a process in which green plants utilize the energy of sunlight to manufacture carbohydrates from carbon dioxide and water in the presence of chlorophyll. A vast majority of plants contain chlorophyll—concentrated, in the higher land plants, in the leaves. In these plants water is absorbed by the roots and carried to the leaves by the xylem, and carbon dioxide is obtained from air that enters the leaves through the stomata and diffuses to the cells containing chlorophyll. The green pigment chlorophyll is uniquely capable of converting the active energy of light into a latent form that can be stored (in food) and used when needed.

2.1 Photosynthetic process

The initial process in photosynthesis is the decomposition of water (H_2O) into oxygen and hydrogen and oxygen will be released. Direct light is required for this process. The hydrogen and the carbon and oxygen of carbon dioxide (CO_2) are then converted into a series of increasingly complex compounds that result finally in a stable organic compound, glucose ($\text{C}_6\text{H}_{12}\text{O}_6$), and water. This phase of photosynthesis utilizes stored energy and therefore can proceed in the dark.

The simplified equation of this overall process is

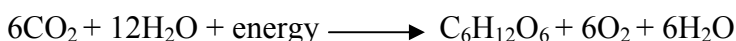

In general, the results of this process are the reverse of those in respiration, in which carbohydrates are oxidized to release energy, with the production of carbon dioxide and water. The intermediary reactions before glucose is formed involve several enzymes, which react with

the coenzyme ATP (Adenosine Triphosphate) to produce various molecules. Studies using radioactive carbon have indicated that among the intermediate products are three-carbon molecules from which acids and amino acids, as well as glucose, are derived. This suggests that fats and proteins are also products of photosynthesis. The main product, glucose, is the fundamental building block of carbohydrates (e.g., sugars, starches, and cellulose). The water-soluble sugars (e.g., sucrose and maltose) are used for immediate energy. The insoluble starches are stored as tiny granules in various parts of the plant chiefly the leaves, roots (including tubers), and fruits and can be broken down again when energy is needed. Cellulose is used to build the rigid cell walls that are the principal supporting structure of plants.

2.2 Importance of Photosynthesis

Animals and plants both synthesize fats and proteins from carbohydrates; thus glucose is a basic energy source for all living organisms. The oxygen released (with water vapor, in transpiration) as a photosynthetic byproduct, principally of phytoplankton, provides most of the atmospheric oxygen vital to respiration in plants and animals, and animals in turn produce carbon dioxide necessary to plants. Photosynthesis can therefore be considered the ultimate source of life for nearly all plants and animals by providing the source of energy that drives all their metabolic processes. Green plants use the energy in sunlight to carry out chemical reactions, such as the conversion of carbon dioxide into oxygen. Photosynthesis also produces the sugars that feed the plant.

2.3 Plant photosynthesis

Plants are photoautotrophs, which mean they are able to synthesize food directly from inorganic compounds using light energy, instead of eating other organisms or relying on material derived from them. This is distinct from chemoautotrophs that do not depend on light energy, but use energy from inorganic compounds. The energy for photosynthesis ultimately comes from absorbed photons and involves a reducing agent, which is water in the case of plants, releasing oxygen as a waste product. The light energy is converted to chemical energy, in the form of ATP and NADPH, using the light-dependent reactions and is then available for carbon fixation. Most notably plants use the chemical energy to fix carbon dioxide into carbohydrates and other organic compounds through light-independent reactions. The overall equation for photosynthesis in green plants is:



where n is defined according to the structure of the resulting carbohydrate. However, hexose sugars and starch are the primary products, so the following generalized equation is often used to represent photosynthesis:

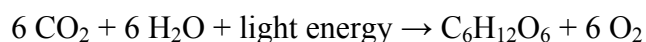

More specifically, photosynthetic reactions usually produce an intermediate product, which is then converted to the final hexose carbohydrate products. These carbohydrate products are then variously used to form other organic compounds, such as the building material cellulose, as precursors for lipid and amino acid biosynthesis or as a fuel in cellular respiration. The latter not only occurs in plants, but also in animals when the energy from plants get passed through a food chain. In general outline, cellular respiration is the opposite of photosynthesis. Glucose and other compounds are oxidized to produce carbon dioxide, water, and chemical energy. However, both processes actually take place through a different sequence of reactions and in different cellular compartments.

Plants capture light primarily using the pigment chlorophyll, which is the reason that most plants have a green color. The function of chlorophyll is often supported by other accessory pigments such as carotenoids and xanthophylls. Both chlorophyll and accessory pigments are contained in organelles (compartments within the cell) called chloroplasts. Although all cells in the green parts of a plant have chloroplasts, most of the energy is captured in the leaves. The cells in the interior tissues of a leaf, called the mesophyll, contain about half a million chloroplasts for every square millimeter of leaf. The surface of the leaf is uniformly coated with a water-resistant, waxy cuticle, which protects the leaf from excessive evaporation of water as well as decreasing the absorption of ultraviolet or blue light to reduce heating. The transparent, colourless epidermis layer allows light to pass through to the palisade mesophyll cells where most of the photosynthesis takes place. The light energy is converted to chemical energy using the light-dependent reactions. The products of the light dependent reactions are ATP from photophosphorylation and NADPH from photo reduction. Both are then utilized as an energy source for the light-independent reactions.

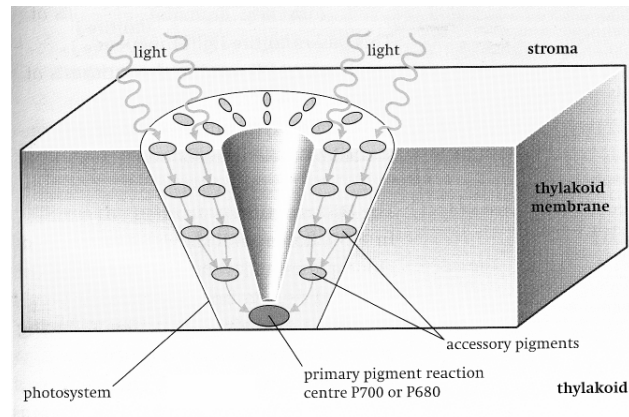

Fig. 1. A photosystem: a light-harvesting cluster of photosynthetic pigments in a chloroplast thylakoid membrane

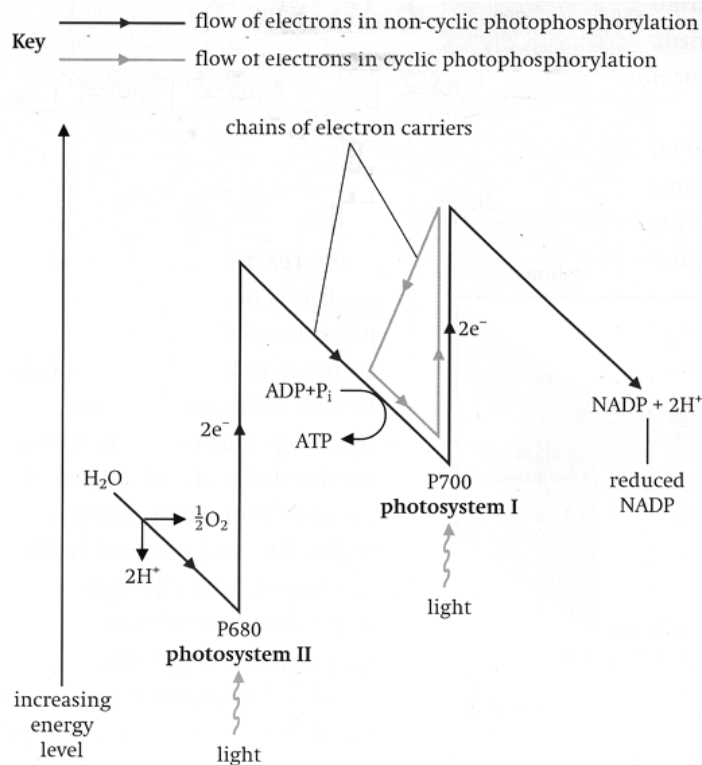

Fig. 2. The 'Z-scheme' of electron flow in light-dependent reactions

2.4 Z scheme

In plants, the light-dependent reactions occur in the thylakoid membranes of the chloroplasts and use light energy to synthesize ATP and NADPH. The photons are captured in the antenna complexes of photosystem I and II by chlorophyll and accessory pigments. When a chlorophyll *a* molecule at a photosystem's reaction center absorbs

energy, an electron is excited and transferred to an electron-acceptor molecule through a process called photo induced charge separation. These electrons are shuttled through an electron transport chain that initially functions to generate a chemiosmotic potential across the membrane, the so called Z-scheme shown in Fig. 2. An ATP synthase enzyme uses the chemiosmotic potential to make ATP during photophosphorylation while NADPH is a product of the terminal redox reaction in the Z-scheme.

2.5 Water photolysis

The NADPH is the main reducing agent in chloroplasts, which provides a source of energetic electrons to other reactions. Its production leaves chlorophyll with a deficit of electrons (oxidized), which must be obtained from some other reducing agent. The excited electrons lost from chlorophyll in photosystem I are replaced from the electron transport chain by plastocyanin. However, since photosystem II includes the first steps of the Z-scheme, an external source of electrons is required to reduce its oxidized chlorophyll *a* molecules. This role is played by water during a reaction known as photolysis and results in water being split to give electrons, oxygen and hydrogen ions. Photosystem II is the only known biological enzyme that carries out this oxidation of water. Initially, the hydrogen ions from photolysis contribute to the chemiosmotic potential but eventually they combine with the hydrogen carrier molecule NADP^+ to form NADPH. Oxygen is a waste product of photosynthesis but it has a vital role for all organisms that use it for cellular respiration.

2.6 Bioenergetics of photosynthesis

Photosynthesis is a physiological phenomenon that converts solar energy into photochemical energy. This physiological phenomenon may be described thermodynamically in terms of changes in energy, entropy and free energy. The energetic of photosynthesis, driven by light, causes a change in entropy that in turn yields a usable source of energy for the plant. The following chemical equation summarizes the products and reactants of photosynthesis in the typical green photosynthesizing plant:



On earth, there are two sources of free energy: light energy from the sun, and terrestrial sources, including volcanoes, hot springs and radioactivity of certain elements. The biochemical value of electromagnetic radiation has led plants to use the free energy from

the sun in particular. Visible light, which is used specifically by green plants to photosynthesize, may result in the formation of electronically excited states of certain substances called pigments. For example, Chl a is a pigment which acts as a catalyst, converting solar energy into photochemical energy that is necessary for photosynthesis. With the presence of solar energy, the plant has a usable source of energy, which is termed as the free energy (G) of the system. However, thermal energy is not completely interconvertible, which means that the character of the solar energy may lead to the limited convertibility of it into forms that may be used by the plant. This relates back to the work of Josiah Willard Gibbs: the change in free energy (ΔG) is related to both the change in entropy (ΔS) and the change in enthalpy (ΔH) of the system (Rabinowitch). Gibbs free energy equation:

$$\Delta G = \Delta H - T\Delta S$$

Past experiments have shown that the total energy produced by photosynthesis is 112 kcal/mol. However in the experiment, the free energy due to light was 120 kcal/mol. An overall loss of 8 kcal/mol was due to entropy, as described by Gibbs equation. In other words, since the usable energy of the system is related directly to the entropy and temperature of the system, a smaller amount of thermal energy is available for conversion into usable forms of energy (including mechanical and chemical) when entropy is great (Rabinowitch). This concept relates back to the second law of thermodynamics in that an increase in entropy is needed to convert light energy into energy suitable for the plant. Overall, in conjunction with the oxidation-reduction reaction, nature of the photosynthesis equation and the interrelationships between entropy and enthalpy, energy in a usable form will be produced by the photosynthesizing green plant.

Energy and carbon are obtained by organisms either directly or indirectly via the photosynthetic conversion of solar energy. These organisms have evolved metabolic machineries for the photochemical reduction of carbon dioxide to organic matter and/or for the subsequent utilization of the organics for biosynthesis and controlled energy liberation. These metabolic routes can be exploited to provide fuels from biochemical sources. The majority of the bioengineering strategies for biochemically derived fuels involve options for the disposition of organic matter produced via photosynthate. The bulk of the presently exploited photosynthate is directed toward the production of wood,

food, and feed. During processing and consumption, waste organic materials are generated which can be used for energy production via combustion, pyrolysis or biochemical conversions to ethanol, hydrogen, methane, and isopropanol. A second option is to engineer the photosynthetic apparatus to provide hydrogen. The third strategy is the cultivation of crops as energy sources, i.e., the farming of an energy crop which can be used as an energy source via the foregoing processes.

The photosynthetic apparatus and the mechanisms by which it operates have been intensively investigated over the past 30 to 40 years. The current understanding is that it consists of three series of interconnected oxidation-reduction reactions: The first involves the evolution of oxygen from water. The second is the transfer of H atoms to a primary hydrogen acceptor. The third is the reduction of CO₂ to carbohydrates by the primary hydrogen acceptor. The light energy required for photosynthesis is used to drive the H atoms against the potential gradient. The photochemical stage of photosynthesis consists of two separate steps, I and II. The products of light reaction II are an intermediate oxidant and a strong oxidant which is capable of oxidizing water to oxygen. An intermediate oxidant and a strong reductant that can reduce carbon dioxide are produced in light reaction I. The two light reactions involve two pigment systems, photosystems I and II, interconnected by enzymatic reactions coupled with photophosphorylation yielding adenosine triphosphate (ATP). ATP is one of several high energy (7 to 8 kcal liberated upon hydrolysis per mole) compounds used in biological systems for chemical energy storage.

3. Glycolysis

It is a series of biochemical reactions by which a molecule of glucose is oxidized to two molecules of pyruvic acid. The word glycolysis is from Greek glyk meaning sweet and lysis meaning dissolving. It is the initial process of many pathways of carbohydrate catabolism, and serves two principal functions: generation of high-energy molecules (ATP and NADH), and production of a variety of six- or three-carbon intermediate metabolites, which may be removed at various steps in the process for other intracellular purposes (such as nucleotide biosynthesis). Glycolysis is one of the most universal metabolic processes known, and occurs (with variations) in many types of cells in nearly all types of organisms. Glycolysis alone produces less energy per glucose molecule than

complete aerobic oxidation, and so flux through the pathway is greater in anaerobic conditions (i.e., in the absence of oxygen). The most common and well-known type of glycolysis is the Embden-Meyerhof pathway, initially elucidated by Gustav Embden and Otto Meyerhof. The term can be taken to include alternative pathways, such as the Entner-Doudoroff Pathway. However, glycolysis will be used as a synonym for the Embden-Meyerhof pathway. The overall reaction of glycolysis is:



So, for simple fermentations, the metabolism of 1 molecule of glucose has a net yield of 2 molecules of ATP. Cells performing respiration synthesize more ATP, but this is not considered part of glycolysis proper, although these aerobic reactions do use the product of glycolysis. Eukaryotic aerobic respiration produces an additional 34 molecules (approximately) of ATP for each glucose molecule oxidized. Unlike most of the molecules of ATP produced via aerobic respiration, those of glycolysis are produced by substrate-level phosphorylation.

3.1 Biochemical oxidations

Respiration refers to those biochemical processes in which organisms oxidize organic matter and extract the stored chemical energy needed for growth and reproduction. Respiration patterns may be subdivided into two major groups, based on the nature of the ultimate electron acceptor. Although alternative pathways exist for the oxidation of various organic substrates, it is convenient to consider only the degradation of glucose. (The metabolic routes provide the means for metabolism of pentoses and for interconversions between sugars and other metabolites.) The breakdown of glucose is via the Embden-Meyerhof-Parnas glycolytic pathway which yields 2 moles each of pyruvate, ATP, and reduced nicotinamide adenine dinucleotide (NAD) per mole of glucose. Under aerobic conditions, the pyruvate is oxidized to CO_2 and H_2O via the tricarboxylic acid or Krebs cycle and the electron transport system. The net yield for glycolysis followed by complete oxidation is 38 moles ATP per mole glucose, although there is evidence that the yield for bacteria is 16 moles ATP per mole of glucose (Ref. 6). Thus, 673 kcal are liberated per mole glucose, much of which is stored as ATP. Under anaerobic conditions, various pathways exist for pyruvate metabolism which serves to reoxidize the reduced hydrogen carriers formed during glycolysis. The ultimate acceptor builds up as a waste

product in the culture medium. The end products of the pathways are: (1) CO₂, ATP, and acetate; (2) CO₂ and ethanol; (3) H₂ and CO₂; (4) CO₂ and 2, 3-butylene glycol; (5) CO₂, H₂, acetone, ATP, and butanol; (6) succinate; and (7) lactate. The pathway that occurs depends on the microorganism cultivated and the culture. In terms of energy liberation, the anaerobic fermentations are inherently inefficient. The end products of these metabolic activities are reduced and possess high heats of combustion. Several examples are shown in Table 1. It is the value of these products for various purposes including fuels which make the anaerobic oxidation of organic substrates attractive.

Table 1. Heats of combustion for theoretical oxidation of glucose by various routes are shown as kcal per mole of glucose fermented

Products	Heat of Combustion
2 CO ₂ + 2 C ₂ H ₅ OH	654
2 Lactic acid	652
3 CH ₄ + 3 CO ₂	634
H ₂ O + CO ₂	0
Lactic acid	654
Mixed acid (<i>Escherichia</i>)	633

4. Biological Nitrogen Fixation

Nitrogen fixation is the process by which nitrogen is taken from its relatively inert molecular form (N₂) in the atmosphere and converted into nitrogen compounds useful for other chemical processes (such as, notably, ammonia, nitrate and nitrogen dioxide).

Biological Nitrogen Fixation (BNF) is where atmospheric nitrogen is converted to ammonia by a bacterial enzyme called nitrogenase. Microorganisms that fix nitrogen are called diazotrophs. The formula for BNF is:

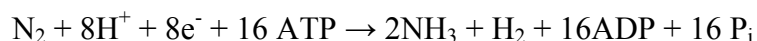

Although ammonia (NH₃) is the direct product of this reaction, it is quickly ionized to ammonium (NH₄⁺) ions. In free-living diazotrophs, the nitrogenase-generated ammonium ions are assimilated into glutamate through the glutamine synthetase/glutamate synthase pathway. Biological nitrogen fixation was discovered by the Dutch microbiologist Martinus Beijerinck.

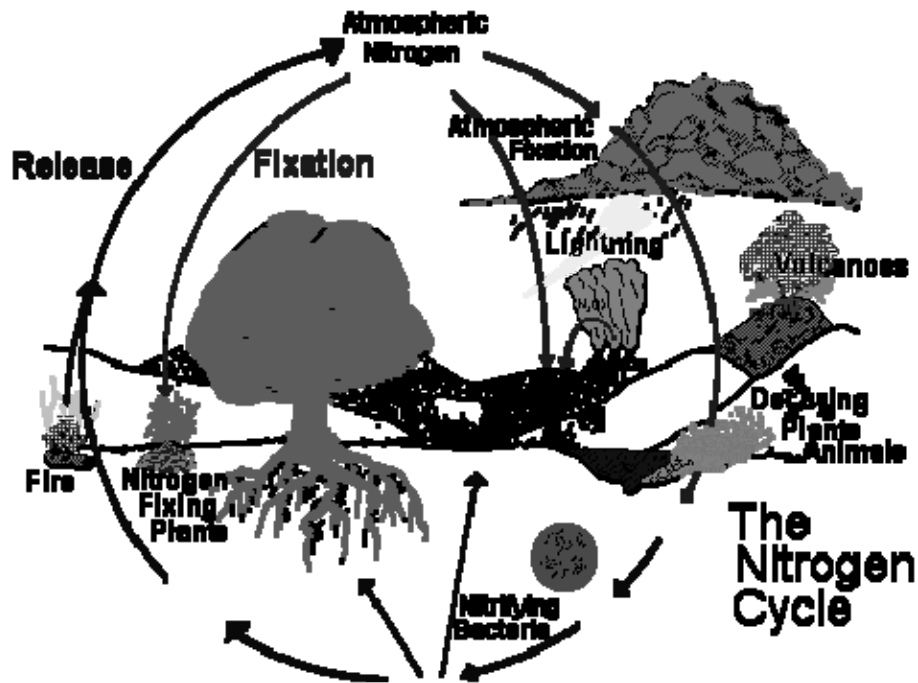

Fig. 3. Schematic representation of nitrogen cycle

4.1 Leguminous nitrogen-fixing plants

The best-known are legumes such as clover, which contain symbiotic bacteria called rhizobia within nodules in their root systems, producing nitrogen compounds that help to fertilize the soil. The great majority of legumes have this association, but a few genera (e.g., *Styphnolobium*) do not.

5. Fermentation

The anaerobic conversion of sugar to carbon dioxide and alcohol by yeast is known as Fermentation. Since fruits ferment naturally, fermentation precedes human history. However, humans began to take control of the fermentation process at some point. There is strong evidence that people were fermenting beverages in Babylon circa 5000 BC, ancient Egypt circa 3000 BC, pre-Hispanic Mexico circa 2000 BC, and Sudan circa 1500 BC. There is also evidence of leavened bread in ancient Egypt circa 1500 BC and of milk fermentation in Babylon circa 3000 BC. The Chinese were probably the first to develop vegetable fermentation.

Fermentation is a process by which the living cell is able to obtain energy through the breakdown of glucose and other simple sugar molecules without requiring oxygen. Fermentation is achieved by somewhat different chemical sequences in different species of organisms. Two closely related paths of fermentation predominate for glucose. When muscle tissue receives sufficient oxygen supply, it fully metabolizes its fuel glucose to water and carbon dioxide. However, at times of strenuous activity, muscle tissue uses oxygen faster than the blood can supply it. During this anaerobic condition, the six-carbon glucose molecule is only partly broken down to two molecules of the three-carbon sugar called lactic acid. This process, called lactic acid fermentation, also occurs in many microorganisms and in the cells of higher animals. In alcoholic fermentation, such as occurs in brewer's yeast and some bacteria, the production of lactic acid is bypassed, and the glucose molecule is degraded to two molecules of the two-carbon alcohol, ethanol, and to two molecules of carbon dioxide. Many of the enzymes of lactic acid and alcoholic fermentation are identical to the enzymes that bring about the metabolic conversion known as glycolysis. Alcoholic fermentation is a process that was known to antiquity.

5.1 Ethanol fermentation

Ethyl alcohol is produced biologically by the well-known yeast fermentation. Alcohol-tolerant strains of *Saccharomyces cerevisiae* are usually used. *S. cerevisiae* converts hexose sugars to ethanol and carbon dioxide, theoretically yielding 51 and 49 percent by weight, respectively. *S. anamensis* and *Schizosaccharomyces pombe* are also used. *Candida pseudotropicalis* is utilized for the ethanol fermentation from lactose, and *C. utilis* from pentoses. Ethanol can be fermented from any carbohydrate, although starchy or cellulosic materials require a pretreatment step for hydrolysis. The usable raw materials can be categorized as saccharin (sugarcane, sugar beets, molasses, and fruit juices), starchy (cereals and potatoes), or cellulosic (wood and waste sulfite liquor). The environmental conditions of the alcoholic fermentation vary somewhat, depending primarily on the strain of yeast. Acidic conditions are used to inhibit bacterial contaminants. The initial pH is in the range of 4.0 to 5.5. Suitable temperatures are of the order of 20 to 30 deg C. Industrial alcoholic fermentations are normally operated on a batch basis, the process being completed within 50 hours. Yields are in excess of 90 percent of theoretical, based on fermentable sugars. The concentration of alcohol in the

culture medium depends on the alcohol tolerance of the yeast. Typically, this is on the order of 10 to 20 percent which is increased by distillation and other techniques. The economics of the ethanol fermentation depend on the cost associated with the carbohydrate feed material and the market for nonalcoholic by-products. These by-products consist of grain residues, recovered carbon dioxide, and the residual cells. Recovered grain and cells are normally sold as feed materials.

Table 2. Heats of combustion and costs of various fuels

Fuel	kcal/gram*	Btu/pound	\$/million Btu
Ethanol	327.6	12,790	
Synthetic	6.54-10.70
Fermentative			17.82-23.80
Hydrogen	68.4	61,500	0.89-1.02
Methane	210.8	23,600	
Natural gas -- wellhead	0.20-0.25
Consumers	0.75-1.00
Anaerobic digestion	
Substitute natural gas			0.52-1.50
Methanol	170.9	9,990	
Natural	14.68
Synthetic	3.86
Isopropanol	474.8	14,210	
Synthetic	5.18

In recent years, chemosynthesis has largely displaced fermentation for the industrial production of ethyl alcohol. Synthetic ethanol is manufactured from ethylene by

absorption in concentrated sulfuric acid followed by hydrolysis of the ethyl sulfates to ethyl alcohol, or by the direct catalytic hydration of ethylene.

As of the mid-1970s, 80 percent of the ethanol synthesized in the United States is via the catalytic process (ref. 10). The synthetic processes yield 0.25 gallon ethanol per pound of ethylene and 0.58 gallon per gallon of ethyl sulfate. Mid-1970s prices for industrial ethyl alcohol are summarized in Table 2. Goldstein has estimated that for corn at \$1.80 per bushel (1974 support price was \$1.30 per bushel* (8 corn/dry gallon)), fermentation is competitive when ethylene exceeds \$0.18 per pound, approximately triple the 1974 price.

* 1 US bushel = The United States or Winchester bushel was originally defined as the volume of a cylindrical container 18¹/₂ inches in diameter and 8 inches deep; it is now defined as 2150.42 cubic inches exactly.

1 US bushel = 35.24 liters = 8 corn/dry gallon

5.2 Butanol-isopropanol fermentation

The butanol-isopropanol fermentation is mediated by the anaerobic bacterium *Clostridium butylicum*. A wide variety of carbohydrate feeds may be used. Saccharin feeds yield 30 to 33 percent mixed solvents, based on the original sugars. At 33 to 37 deg C. the fermentation is complete within 30 to 40 hours. Product ratios vary with the strain and with culture conditions, but are normally in the range 33 to 65 percent n-butanol, 19 to 44 percent isopropanol, 1 to 24 percent acetone, and 0 to 3 percent ethanol. This fermentation has been supplanted by petrochemical synthetic processes.

5.3 Methane fermentation

Methane and carbon dioxide are the primary gaseous end products of the anaerobic digestion process which have been widely used for many years in the stabilization of organic sewage solids. The quality of the digester off-gases is dependent upon feed composition. Mixed feeds normally yield approximately 65 percent methane and 35 percent carbon dioxide. Approximately equal volumes arise from carbohydrates, and the methane yield increases with proteins and lipids. In addition, the product gases contain small volumes of hydrogen sulfide and nitrogen. The generation of methane occurs as the last step of a series of biochemical reactions. The reactions are divided into three groups, each mediated by heterogeneous assemblages of microorganisms, primarily bacteria. A complex feed, consisting of high-molecular-weight bipolymers, such as carbohydrates,

fats, and proteins, undergoes exocellular enzymatic hydrolysis as the first step. The hydrolytic end products are the respective monomers (or other low-molecular-weight residues), such as sugars, fatty acids, and amino acids. These low-molecular-weight residues are taken up by the bacterial cell before further metabolic digestion. The second step is acid production in which the products of hydrolysis are metabolized to various volatile organic fatty acids. The predominant fatty acids are acetic and propionic acids. Other low-molecular-weight acids, such as formic, butyric and valeric acid have been observed. Additional end products of the acid production step include lower alcohols and aldehydes, ammonia, hydrogen sulfide, hydrogen, and carbon dioxide.

The products of the acid generation step are metabolized by the methane-producing bacteria to yield carbon dioxide and methane, and, in addition, methane arises from metabolic reactions involving hydrogen and carbon dioxide. Anaerobic digestion of organic solid wastes has been investigated as an alternative methane source. Various cost estimates have been made which indicate production costs, including gas purification and compression, in the range of \$0.40 to \$2.00 per million Btu. The major cost items, and sources of variability in the estimates, are the digester capital costs, waste sludge disposal cost, and the credit or debit associated with the collection and preparation of the solid waste feed material. Multiple staging and separate optimization of anaerobic digestion may provide reduced capital costs through lower detention times and reduced operation and maintenance costs by improved process stability.

5.4 Hydrogen fermentation

Hydrogen gas is a product of the mixed acid fermentation of *Escherichia coli*, the butylene glycol fermentation of *Aerobacter*, and the butyric acid fermentations of *Clostridium* spp. A possible fruitful research approach would be to seek methods of improving the yield of hydrogen.

6. Biochemical fuel cells

Young et al. have discussed the possibilities of utilizing biological processes as an integral part of fuel cells. They define three basic types of biochemical fuel cells: (1) depolarization cells in which the biological system removes an electrochemical product, such as oxygen; (2) product cells in which an electrochemically active reactant, such as hydrogen, is biologically produced; and (3) redox cells (oxidation-reduction) in which

electrochemical products are converted to reactants (ferricyanide/ferrocyanide system) by the biological system. Young et al. concluded that application of biochemical fuel cells will most probably involve immobilized enzymes as a method of increasing efficiency and decreasing costs.

During the 20th century, energy consumption increased dramatically and an unbalanced energy management exists. While there is no sign that this growth in demand will abate (particularly amongst the developing nations), there is now an awareness of the transience of nonrenewable resources and the irreversible damage caused to the environment. In addition, there is a trend towards the miniaturization and portability of computing and communications devices. These energy-demanding applications require small, light power sources that are able to sustain operation over long periods of time, particularly in remote locations such as space and exploration.

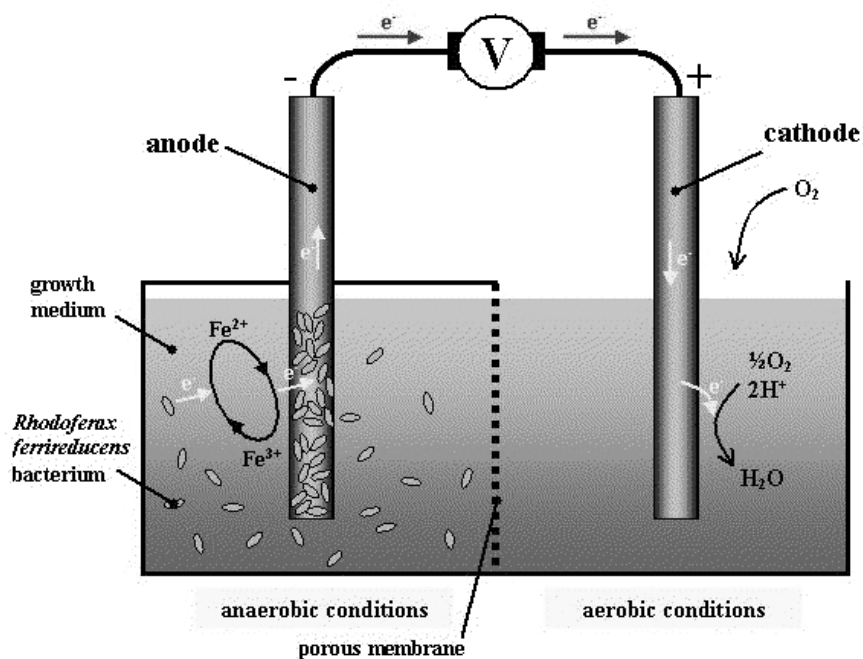

Fig. 4. A biofuel cell using *R. ferrireducens*

Biofuel cells use biocatalysts for the conversion of chemical energy to electrical energy. As most organic substrates undergo combustion with the evolution of energy, the biocatalyzed oxidation of organic substances by oxygen or other oxidizers at two-electrode interfaces provides a means for the conversion of chemical to electrical energy.

Abundant organic raw materials such as methanol, organic acids, or glucose can be used as substrates for the oxidation process, and molecular oxygen or H_2O_2 can act as the substrate being reduced. The extractable power of a fuel cell (P_{cell}) is the product of the cell voltage (V_{cell}) and the cell current.

7. Biological H_2 production

The inevitable consumption of all our supplies of fossil fuels requires the development of alternative sources of energy for the future. Introduction of a hydrogen economy will gain great importance due to the promise of using hydrogen over fossil fuels. These advantages include its limitless abundance and also its ability to burn without generating any toxic byproducts, where the only by-product of hydrogen combustion is water. Steam reforming is the major process for the production of hydrogen presently. This process has several disadvantages. For example, it is a thermally inefficient process (about 90 % including the convection zone) and there are mechanical and maintenance issues. The process is difficult to control and reforming plants require a large capital investment. Hence to meet the increasing demand for this future fuel, alternatives to reforming processes are essential. Direct photo-biological H_2 production by photosynthetic microorganisms is an active developing field nowadays. Realization of technical processes for large-scale photo-biological H_2 production from water, using solar energy, would result in a major novel source of sustainable, environmentally friendly and renewable energy. The unique biological process of photosynthesis in which solar energy is used to split water is combined with the natural capacity to combine obtained products into H_2 , catalyzed by enzymes called hydrogenases. In nature, only cyanobacteria and green algae possess water oxidizing photosynthesis and H_2 production, providing the option to form hydrogen from sun and water. *Anabaena variabilis* ATCC 29413 is a filamentous heterocyst-forming cyanobacterium that fixes nitrogen and CO_2 using the energy of sunlight via oxygen-evolving plant-type photosynthesis. In addition, this strain has been studied extensively for the production of hydrogen using solar energy. It has a complex life cycle that includes multiple types of differentiated cells: heterocysts for nitrogen fixation, akinetes (spores) for survival, and hormogonia for motility and for the establishment of symbiotic associations with plants and fungi. Biomass-derived synthesis gas can provide a renewable route to hydrogen. A novel bacterial process has been

proposed as an alternative to the conventional high-temperature catalytic process for the production of H_2 from synthesis gas via the Water-Gas Shift (WGS) reaction. Hydrogen can be produced via pyrolysis or gasification of biomass resources such as agricultural residues like peanut shells; consumer wastes including plastics and waste grease; or biomass specifically grown for energy uses. Biomass pyrolysis produces a liquid product (bio-oil) that contains a wide spectrum of components that can be separated into valuable chemicals and fuels, including hydrogen. Increase in the production of hydrogen from biomass-derived glucose and attainment of the maximum molar yield of H_2 , can be achieved through the enzymes of the pentose phosphate cycle in conjunction with a hyperthermophilic hydrogenase. This process centers on three $NADP^+$ dependent enzymes, glucose-6 phosphate dehydrogenase (G6PDH), 6-phosphogluconate dehydrogenase (6PGDH) and hydrogenase from *Pyrococcus furiosus*. The dehydrogenases are currently obtained from mesophilic sources.

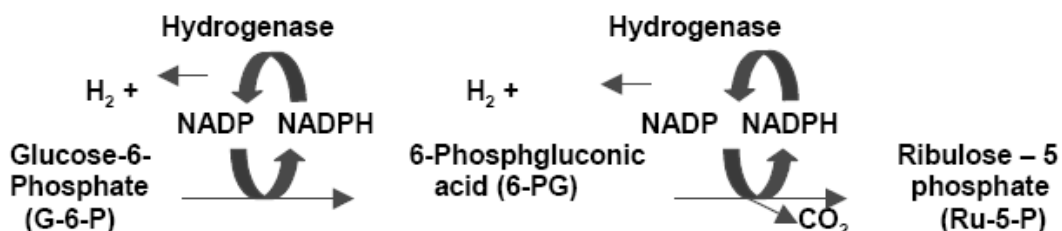

Fig. 5. In vitro enzymatic pathway to produce molecular hydrogen

The enzymatic conversion of cellulosic waste to H_2 via an *in vitro* enzymatic pathway involves the conversion of potential glucose sources such as cellulose by cellulases and plant sap (i.e. sucrose) by invertase and glucose isomerase to glucose. Glucose, the sugar produced by photosynthesis, is also renewable, unlike fossil fuels such as oil. The glucose substrate is then oxidized and the cofactor, $NADP^+$ is simultaneously reduced. The presence of a pyridine dependent- hydrogenase in this system causes the regeneration and recycling of $NAD(P)^+$ with the concomitant production of molecular hydrogen. The overall aim is to increase the production of hydrogen from biomass-derived glucose and achieve the maximum molar yield of H_2 by employing the enzymes of the pentose phosphate pathway in conjunction with the hydrogenase from *Pyrococcus furiosus*. This

will also require the future development of an immobilized enzyme bioreactor for efficient hydrogen production at high theoretical yields. If this could be achieved practically, this would represent a major innovation that would advance our abilities to develop an efficient and practical system for biohydrogen production. The main advantage over hydrogen production by fermentation is that close-to-theoretical yields of hydrogen from sugar would be possible.

8. Bio diesel

Transesterification of a vegetable oil was conducted as early as 1853, by scientists E. Duffy and J. Patrick, many years before the first diesel engine became functional. Rudolf Diesel's prime model, a single 10 ft (3 m) iron cylinder with a flywheel at its base, ran on its own power for the first time in Augsburg, Germany on August 10, 1893. In remembrance of this event, August 10 has been declared International Biodiesel Day. Diesel later demonstrated his engine and received the "Grand Prix" (highest prize) at the World Fair in Paris, France in 1900. This engine stood as an example of Diesel's vision because it was powered by peanut oil a biofuel, though not strictly biodiesel, since it was not transesterified. He believed that the utilization of a biomass fuel was the real future of his engine. In a 1912 speech, Rudolf Diesel said, "the use of vegetable oils for engine fuels may seem insignificant today, but such oils may become, in the course of time, as important as petroleum and the coal-tar products of the present time". Biodiesel is a clear amber-yellow liquid with a viscosity similar to petrodiesel, the industry term for diesel produced from petroleum. It can be used as an additive in formulations of diesel to increase the lubricity of pure ultra-low sulfur petrodiesel (ULSD) fuel. Much of the world uses a system known as the "B" factor to state the amount of biodiesel in any fuel mix, in contrast to the "BA" system used for bioalcohol mixes. For example, fuel containing 20 % biodiesel is labeled B20. Pure biodiesel is referred to as B100. The common international standard for biodiesel is EN 14214. Biodiesel refers to any diesel-equivalent biofuel usually made from vegetable oils or animal fats. Several different kinds of fuels are called biodiesel: usually biodiesel refers to an ester, or an oxygenate, made from the oil and methanol, but alkane (non-oxygenate) biodiesel, that is, biomass-to-liquid (BTL) fuel is also available. Sometimes even unrefined vegetable oil is called "biodiesel". Unrefined vegetable oil requires a special engine, and the quality of petrochemical diesel

is higher. In contrast, alkane biodiesel is of a higher quality than petrochemical diesel, and is actually added to petro-diesel to improve its quality.

Biodiesel has physical properties very similar to petroleum-derived diesel fuel, but its emission properties are superior. Using biodiesel in a conventional diesel engine substantially reduces emissions of unburned hydrocarbons, carbon monoxide, sulfates, polycyclic aromatic hydrocarbons, nitrated polycyclic aromatic hydrocarbons, and particulate matter. Diesel blends containing up to 20% biodiesel can be used in nearly all diesel-powered equipments, and higher-level blends and pure biodiesel can be used in many engines with little or no modification. Lower-level blends are compatible with most storage and distribution equipments, but special handling is required for higher-level blends.

Biodiesels are biodegradable and non-toxic, and have significantly fewer emissions than petroleum-based diesel (petro-diesel) when burnt. Biodiesel functions in current diesel engines, and is a possible candidate to replace fossil fuels as the world's primary transport energy source. With a flash point of 160 °C, biodiesel is classified as a non-flammable liquid by the Occupational Safety and Health Administration. This property makes a vehicle fueled by pure biodiesel far safer in an accident than one powered by petroleum diesel or the explosively combustible gasoline. Precautions should be taken in very cold climates, where biodiesel may gel at higher temperatures than petroleum diesel.

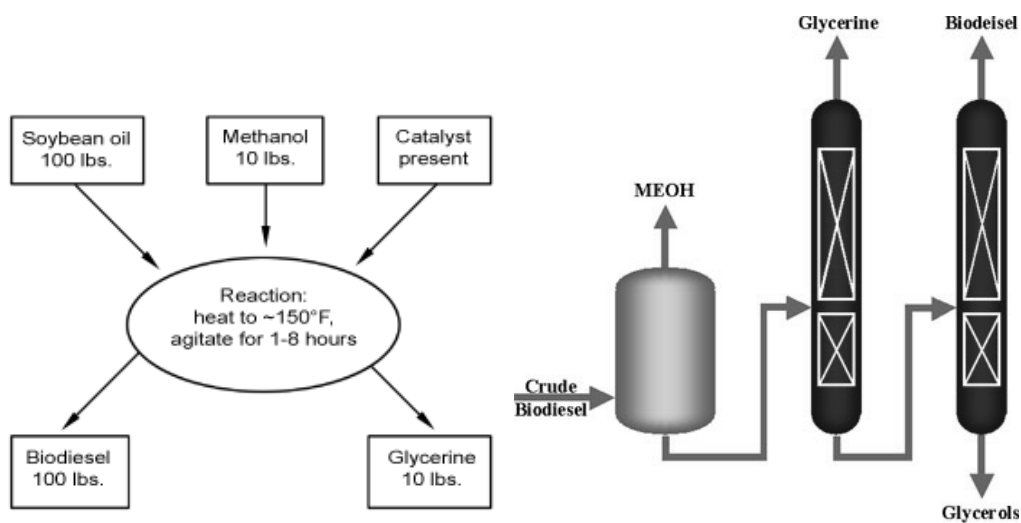

Fig.6. Schematic setup for biodiesel production

Biodiesel can be distributed using today's infrastructure, and its use and production is increasing rapidly (especially in Europe, the United States, and Asia). Fuel stations are beginning to make biodiesel available to consumers, and a growing number of transport fleets use it as an additive in their fuel. Biodiesel is generally more expensive to purchase than petroleum diesel, although this differential may diminish due to economies of scale, the rising cost of petroleum, and government subsidization favoring the use of biodiesel.

8.1 Two real-world issues involving the use of biodiesel

There are a number of different feed stocks (methyl esters, refined canola oil, french fry oil, etc.) that are used to produce biodiesel. But in the end they all have a few common problems. First, any of the biodiesel products have a problem of gelling when the temperatures get below 40 °F. At the present time there is no available product that will significantly lower the gel point of straight biodiesel. A number of studies have concluded that winter operations require a blend of bio, low sulfur diesel fuel (LS), and kerosene (K). The exact blend depends on the operating environment. We have seen successful operations running 65% LS, 30% K, and 5% bio. Other areas have run 70% LS, 20% K, and 10% bio. We have even seen 80% K, and 20% bio. Which mixture you choose is based on volume, component availability, and local economics.

The second problem with biodiesel is that it has a great affinity for water. Some of the water is residual to the processing, and some is coming from storage tank condensation. The presence of water is a problem for a number of reasons: Water reduces the heat of combustion. This means more smoke, harder starting, less power. Water will cause corrosion of vital fuel system components fuel pumps, injector pumps, fuel lines, etc. Water, as it approaches 32°F begins to form ice crystals. These crystals provide sites of nucleation and accelerate the gelling of the residual fuel. Water is part of the respiration system of most microbes. Biodiesel is a great food for microbes and water is necessary for microbe respiration. The presence of water accelerates the growth of microbe colonies which can seriously plug up a fuel system. Bio users that have heated fuel tanks face a year round microbe problem.

9. Biogas

Biogas, also called digester gas, typically refers to methane produced by the fermentation of organic matter including manure, wastewater sludge, municipal solid waste, or any

other biodegradable feedstock, under anaerobic conditions. Biogas is also called swamp gas and marsh gas, depending on where it is produced. The process is popular for treating many types of organic waste because it provides a convenient way of turning waste into electricity, decreasing the amount of waste to be disposed of, and of destroying disease causing pathogens which can exist in the waste stream. The use of biogas is encouraged in waste management because it does not increase the amount of carbon dioxide in the atmosphere, which is responsible for much of the greenhouse effect, if the biomass it is fueled on is regrown. Also, methane burns relatively cleanly compared to coal. Processing of the biodegradable feedstock occurs in an anaerobic digester, which must be strong enough to withstand the buildup of pressure and must provide anaerobic conditions for the bacteria inside. Digesters are usually built near the source of the feedstock, and several are often used together to provide a continuous gas supply. Products put into the digester are composed mainly of carbohydrates with some lipids and proteins.

More recently, developed countries have been making increasing use of gas generated from both wastewater and landfill sites. Landfill gas production is incidental and usually nothing is done to increase gas production or quality. There are indications that slightly wetting the waste with water when it is deposited may increase production, but there is a concern that gas production would be large at first and then drop sharply. Even if not used to generate heat or electricity, landfill gas must be disposed of or cleaned because it contains trace volatile organic compounds (VOCs), many of which are known to be precursors to photochemical smog. Because landfill gas contains these trace compounds, the United States Clean Air Act, and Part 40 of the Federal Code of Regulations, requires landfill owners to estimate the quantity of VOCs emitted. If the estimated VOC emissions exceed 50 metric tons, then the landfill owner is required to collect the landfill gas, and treat it to remove the entrained VOCs. Usually, treatment is by combustion of the landfill gas. Because of the remoteness of landfill sites, it is sometimes not economically feasible to produce electricity from the gas.

Biogas digesters take the biodegradable feedstock, and convert it into two useful products: gas and digestate. The biogas can vary in composition typically from 50-80% methane, with the majority of the balance being made up of carbon dioxide. The digestate

comprises of lignin and cellulose fibers, along with the remnants of the anaerobic microorganisms. This digestate can be used on land as a soil amendment, to increase moisture retention in soil and improve fertility.

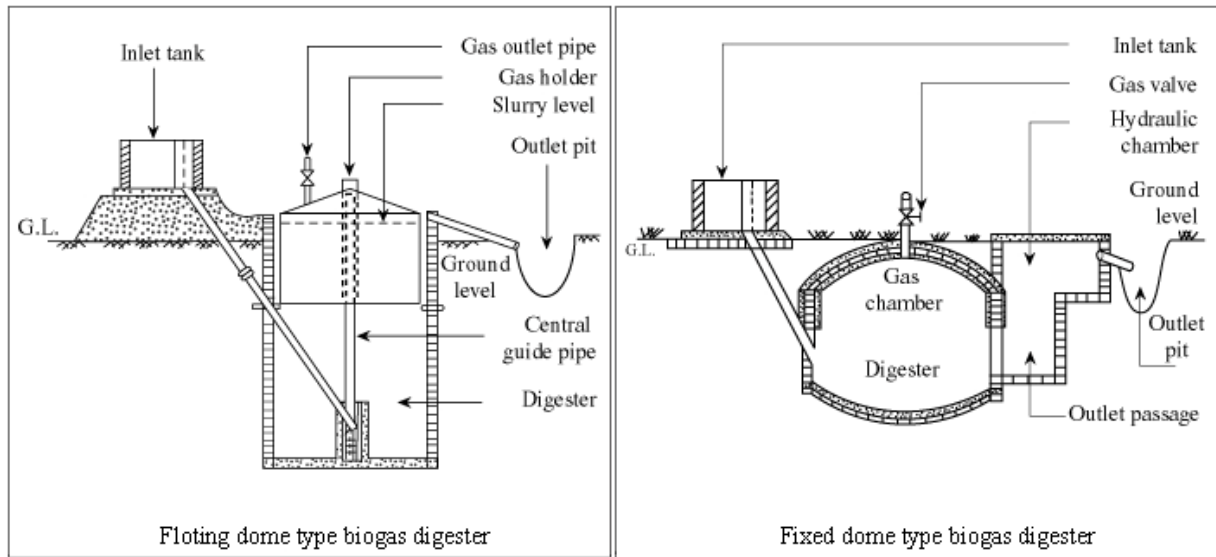

Fig.7. Two different types of biogas digesters

If biogas is cleaned up sufficiently, biogas has the same characteristics as natural gas. More frequently, it is burnt with less extensive treatment on site or nearby. If it is burnt nearby, a new pipeline can be built to carry the gas there. If it is to be transported long distances, laying a pipeline is probably not economical. It can be carried on a pipeline that also carries natural gas, but it must be very clean to reach pipeline quality.

10. Conclusion

Widespread application of biochemical processes will be a function of competition which can occur at any of three levels. At the first level is competition for raw materials. Strong pressure will exist for utilization of photosynthate for food and feed. Waste materials also face competition for alternative uses. Demand may force decisions to direct fermentation toward food and feed production instead of fuel generation. The third level of competition is alternative uses of the end product, such as synthetic feedstock and solvents. The biologically derived products will complement the existing energy structure. Methane gas is easily transportable in the well-developed natural gas

distribution system. Ethyl and isopropyl alcohols have been utilized as gasoline additives for internal combustion engines. Widespread utilization of hydrogen fuel has been anticipated. It is apparent that the production of fuels by biochemical means is feasible and desirable. Process economics and efficiencies require improvement which, in turn, necessitates a concerted and coordinated research effort on the part of the biologists and the engineers. Enzyme and genetic engineering hold the key to improved process efficiencies.

References

1. Rabinowitch, E., and Govindjee: "Photosynthesis," Wiley, New York, 1969.
2. Odum, E.P. "Fundamentals of Ecology," Saunders, Philadelphia, 1959.
3. Prochazka, G.J., W.J. Payne, and W.R. Mayberry: Calorific Contents of Microorganisms, *Biotech. and Bioeng.* 15, 1007-1010 (1973).
4. Oswald, W.J., and C.G. Golueke: Biological Transformation of Solar Energy, *Advan. Appl. Microbiol.*, 2, 223-262 (1960).
5. Hollaender, A.K., J. Monty, R.M Pearlstein, F. Schmidt-Bleek, W.T. Snyder, and E. Volkin: "An Inquiry into Biological Energy Conversion," University of Tennessee, Knoxville, Tenn., 1972.
6. Aiba, S., A.E. Humphrey, and N.F. Millis: "Biochemical Engineering," 2nd ed., Academic, New York, 1973.
7. Prescott S.C., and C.G. Dunn: "Industrial Microbiology," McGraw-Hill, New York, 1959.
8. Narinder I. Heyer and Jonathan Woodward, Proceedings of the 2001 DOE Hydrogen Program Review, NREL/CP-570-30535.